

Contents

Networking with Norstar	1
The Big Picture	1
Bits and pieces	4
Loop start trunks	5
Configuration requirements	5
E&M trunks	6
DID trunks	8
Benefits	10
Security	10
Unified dialing plan	13
Call handling with target lines	15
Customer Use	17
In the public network	18
In the private network	22
In the Norstar system	25
<hr/>	
Installation	29
Module installation	31
Recommended layout	34
System hardware configuration	36
Mounting a module	38
installing the Feature Cartridge	41
Installing an Expansion Cartridge	42
Installing a Trunk Cartridge	44
Upgrading the Software Cartridge	46
Wiring	48
Cable routing in the cable trough	48
Connecting internal wiring	49
Connecting external lines	50
Connecting DS-30 cables	52
Emergency telephones	53
Connecting emergency telephones	53
Testing the emergency telephones	54
Norstar telephones	55
Installing Norstar Telephones	55
Wall-mounting a telephone	56

ii / Contents

Applying the button cap labels	58
Norstar default button assignments	59
Optional equipment	63
'Auxiliary Ringer	63
External music source	64
Installing an external paging system	65
Power Bar installation	66
Power up the Norstar system	67
Telephone relocation and replacement	68
Automatic Telephone Relocation	68
Telephone replacement	69

Regulations	71
--------------------	-----------

Specifications and wiring charts	75
Port numbering	79
Port number coding on the wiring charts	79
Norstar system numbering plan	79
KSU wiring charts	82
Station Module wiring chart	85
Loop Start or CI Trunk Cartridge wiring chart	86
E&M or DISA Trunk Cartridge wiring chart	87
Using the E&M/DISA wiring chart	87
DID Trunk Cartridge wiring chart	91
Using the DID wiring chart	91

Programming	95
Startup defaults	97
Configuration defaults	97
General administration defaults	102
Configuration overview	108
How programming is done	108
Reviewing programmed settings	108
Programming tools	110
Entering Configuration	111
Exiting Configuration	111
Configuration headings	112

Using the Overlay	114
The Norstar display buttons	115
Programming details	116
Trk/Line Data	117
Trunk lines and Target lines	117
T r u n k s	118
Target lines	121
Remote system access	122
Copying Trunk and Line data	124
Trunk data	125
Line data	131
Line Access	134
Call Handling	139
Miscellaneous	143
System Data	151
Set copy	155
Applying Set copy	157

Maintenance	159
Beginning a Maintenance session	160
System Version	161
Port/DN Status	163
Examining Port/DN Status	164
Module Status	170
Examining Module Status	171
Diagnostics	176
Running Diagnostics	177
System Test Log	180
Examining the System Test Log	180
System Administration Log	183
Examining the System Administration Log	183
Alarm codes	185
If you see an alarm code	185
Event messages	190
Dealing with event messages	190
Significant event messages	190
Complete list of event numbers	193
Maintenance records	195
Recording information	195

Version number record	196
System Test Log	197
System Administration Log record	198

Troubleshooting	199
Getting ready	199
Other troubleshooting tools	199
Types of problems	200
General troubleshooting procedure	201
Installation check	202
Testing the Norstar system	202
Checking the hardware	204
Problems with equipment	207
Norstar equipment trouble	207
Symptoms at the alarm telephone	211
Problems with lines	213
Auto-answer line rings at a Norstar telephone	216
Prime telephone gets misdialed calls	216
Selected line shows Not in service	217
Selected line pool shows No free lines	218
Problems with features	219
Problem descriptions	219
Network telephone trouble for remote users	222
Calling directly to Norstar	222
Calling Norstar through DISA	226
Using Norstar remote features	2 2 9
Calling through Norstar to another system	230
Problems with optional equipment	234
Analog Terminal Adapter (ATA)	234
Auxiliary ringer	235
Call Identification Interface	236
External paging	237

Glossary	239
-----------------	------------

Index	261
--------------	------------

Networking with Norstar

Norstar can now be part of a corporate telecommunications network. You can connect Norstar to an existing private network, or to other Norstar systems to form a Norstar network.

This chapter explains:

- how Norstar components behave in a network,
- how they benefit your business, and
- how you can configure Norstar to achieve those benefits.

The Big Picture

Norstar uses enhanced trunking to join other Norstar or customer equipment in a private network. Authorized users can also access tie-lines, Central Office lines, and Norstar features from outside the Norstar system.

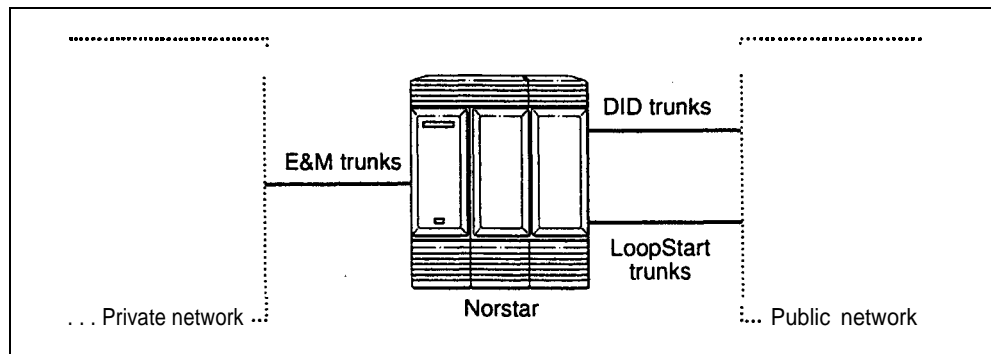

Norstar as an OPX

Norstar can be used as an off premise extension (OPX) from a PBX. In order to support this application, the OPX lines must be engineered not to exceed 7 dB total loop loss from the serving central office to the demarcation point at the Norstar KSU.

Bits and pieces

The trunks and lines that Norstar uses make network access possible. Target lines concentrate incoming calls on fewer trunks, and three types of trunks provide the network access:

- ▮ E&M trunks handle incoming and outgoing traffic between the Norstar system and the private network.
- DID trunks route incoming calls from the public network directly to telephones within Norstar, without an attendant.
- ▮ loop start trunks handle incoming and outgoing calls between Norstar and the public network.

Benefits

Security

Norstar provides the security that expanded access demands.

You can:

- control remote access to tie-lines, Central Office lines, and system features by setting up a specific Class of Service for each type of caller,
- ▮ restrict outgoing calls to certain telephone numbers or area codes by applying dialing filters to lines and telephones, and
- screen remote callers by configuring trunks to answer with DISA, a system response that requires callers to enter a valid password.

Unified dialing plan

When you link a number of Norstar systems into a network, you can configure them so that the length of Directory Numbers (DNs), the line pools, and the line pool access codes are consistent from one system to the next.

Call handling capabilities

In the Norstar system, the concentrated environment supports call handling features on up to 184 lines, of which 80 are physical trunks and 104 are target (virtual) lines.

Customer use

Callers in the public network can:

- call directly to one or more **Norstar** telephones,
- call into the **Norstar** system and select outgoing tie-lines to access the private network,
- call into the **Norstar** system and select outgoing Central Office lines to access the public network, and
- call into the **Norstar** system and use remote features.

Callers in the private network can:

- call directly to one or more **Norstar** telephones,
- call into the **Norstar** system and select outgoing tie-lines to access other nodes in the private network,
- call into the **Norstar** system and select outgoing Central Office lines to access the public network, and
- call into the **Norstar** system and use remote features.

Callers in the **Norstar** system can:

- call directly to a specific **Norstar** telephone,
- select outgoing tie-lines to access the private network,
- select outgoing tie-lines to access features that are available on the private network,
- select outgoing Central Office lines to access the public network, and
- use all of the **Norstar** features.

Bits and pieces

To understand the capabilities that are described later in this chapter, you need to know how the trunks and lines behave in the Norstar system.

A trunk is a physical connection between the Norstar system and the outside world. A line is a flexible communication path between a Norstar user and the outside world. This allows a one-to-many relationship between trunks and lines.

What this means is that one trunk does not have to represent one line, but can represent several lines. You achieve this in two ways:

1. **Auto-answer trunks** — If you want one trunk to serve many lines, you configure it as Auto-answer. The Norstar system answers calls and maps incoming digits onto numbers that you define in programming. The numbers can access the system, so that callers can then use selected features or call out to another destination (calling through the system). The numbers can also access target lines that appear on one or more Norstar telephones.
2. **Target lines** — incoming calls on one trunk can map onto a number of different target lines. These are virtual lines that can appear on a Norstar telephone like any other line. They are incoming lines only, and cannot be selected for outgoing calls. They are identified to the system by their number. Any line with a number from 081 to 184 is a target line.

Of course, you can still have a one-to-one relationship between a trunk and a line. In this case, you configure the trunk as manual-answer.

You can read more on target lines in the Programming chapter. To learn more about the types of trunks and the important differences between auto-answer and manual-answer trunks, read on.

Loop start trunks

Loop start trunks give you incoming and outgoing access to the public network. However, you would typically configure your system with loop start trunks for outgoing calls and DID trunks for incoming calls. Loop start trunks can be configured as manual-answer or auto-answer.

When a call comes in on a manual-answer loop start trunk, it alerts at all telephones with that line appearance.

When a call comes in on an auto-answer loop start trunk, you hear a stuttered dial tone if the trunk is configured to answer with DISA. Then you must use a DTMF telephone to enter a 6-digit Class of Service password.

When a call comes in on an auto-answer loop start trunk, you hear the system dial tone if the trunk does not have DISA, or if the Class of Service password is valid. Use a DTMF telephone to enter a target line number, the DISA DN, a line pool access code, or a remote feature code.

To place an outgoing call, select a loop start line by dialing a line pool access code, pressing a line button on the telephone, or pressing a memory button that has been programmed with a line pool access, code.

Configuration 'requirements

You need one Loop Start Trunk Cartridge or CI Trunk Cartridge for every four trunks beyond the eight that come with the Key Service Unit. If you wish to configure your loop start lines as auto-answer, the lines must have disconnect supervision. You will also need one **E&M/DISA** Trunk Cartridge for every two loop start lines that you configure as auto-answer. An auto-answer loop start trunk can give you the same kind of direct inward dialing function as a DID trunk, but you will require **E&M/DISA** Trunk Cartridges to receive the incoming digits from the Central Office.

You may configure a loop start line as the Prime line for a Norstar telephone.

E&M trunks

An E&M trunk gives incoming and outgoing tie-line access from other systems in the private network to the Norstar system. E&M trunks can be configured as manual-answer or auto-answer.

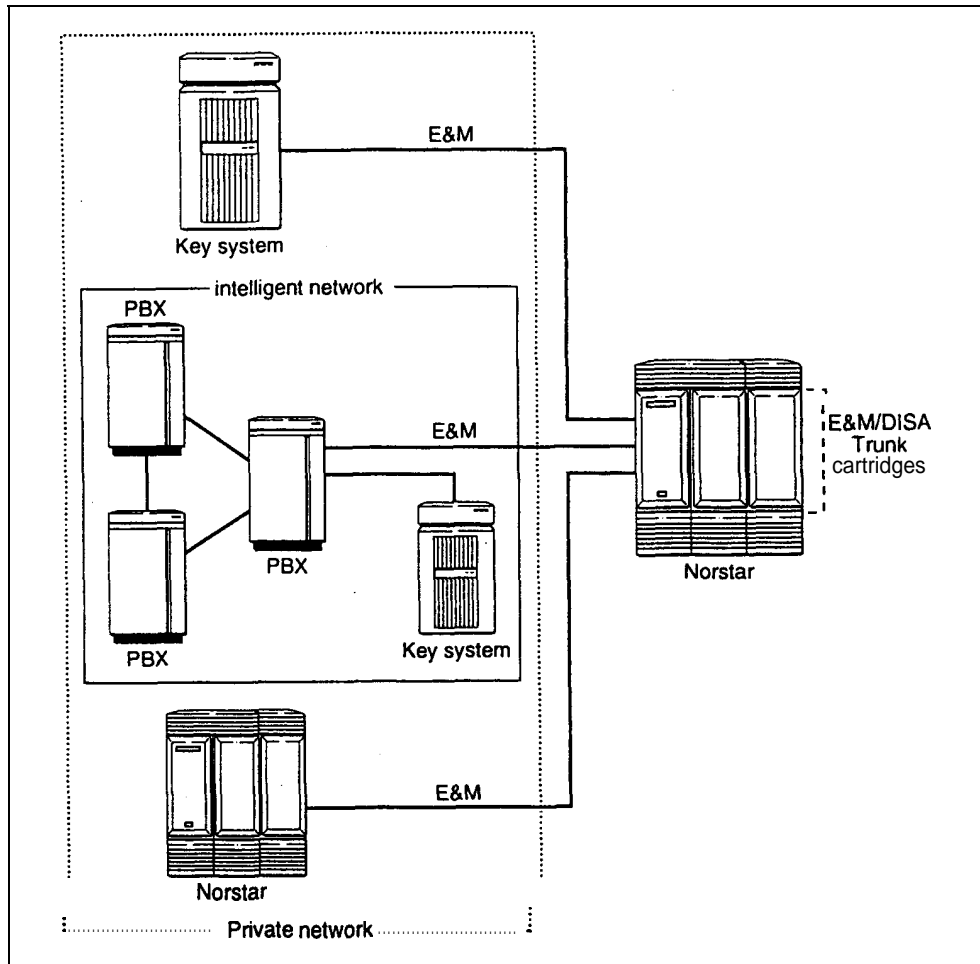

When a call comes in on a manual-answer E&M trunk, it alerts at all telephones with that line appearance.

When a call comes in on an auto-answer E&M trunk, you hear a stuttered dial tone if the trunk is configured to answer with DISA. Then you must use a DTMF telephone to enter a 6-digit Class of Service password.

When a call that comes in on an auto-answer E&M Trunk, you hear the system dial tone if the trunk does not have DISA, or if the password is valid. Use a DTMF telephone to enter a target line number, the DISA DN (the number that will call for a Class of Service password), a line pool access code, or a remote feature code.

When a call comes in on an auto-answer E&M trunk from an intelligent network, the Norstar system answers the call and interprets the incoming digits:

- If the digits map onto a target line, Norstar routes the call to all Norstar devices with an appearance of that line.
- If the digits map onto the DISA DN, you hear a stuttered dial tone, and must use a DTMF telephone to enter a valid Class of Service password to get the system dial tone.
- If the digits map onto the Auto DN (the number for direct system access), you hear the system dial tone, and can use a DTMF telephone to enter a target line number, the DISA DN, a line pool access code, or a remote feature code.

To place an outgoing call, select an E&M trunk by dialing a line pool access code, pressing a line button on the telephone, or pressing a memory button that has been programmed with a line pool access code.

Configuration requirements

In your configuration, one E&M/DISA Trunk Cartridge is required for every two E&M trunks. One E&M/DISA Trunk Cartridge is also required for every two DTMF receivers required for DISA on loop start trunks.

You may configure an E&M trunk as the Prime line for a Norstar telephone.

DID trunks

DID trunks give you direct inward dialing (DID) from the public network to the Norstar system. A typical application of these trunks is to map incoming digits onto target line appearances within the Norstar system. DID trunks can operate only as auto-answer trunks.

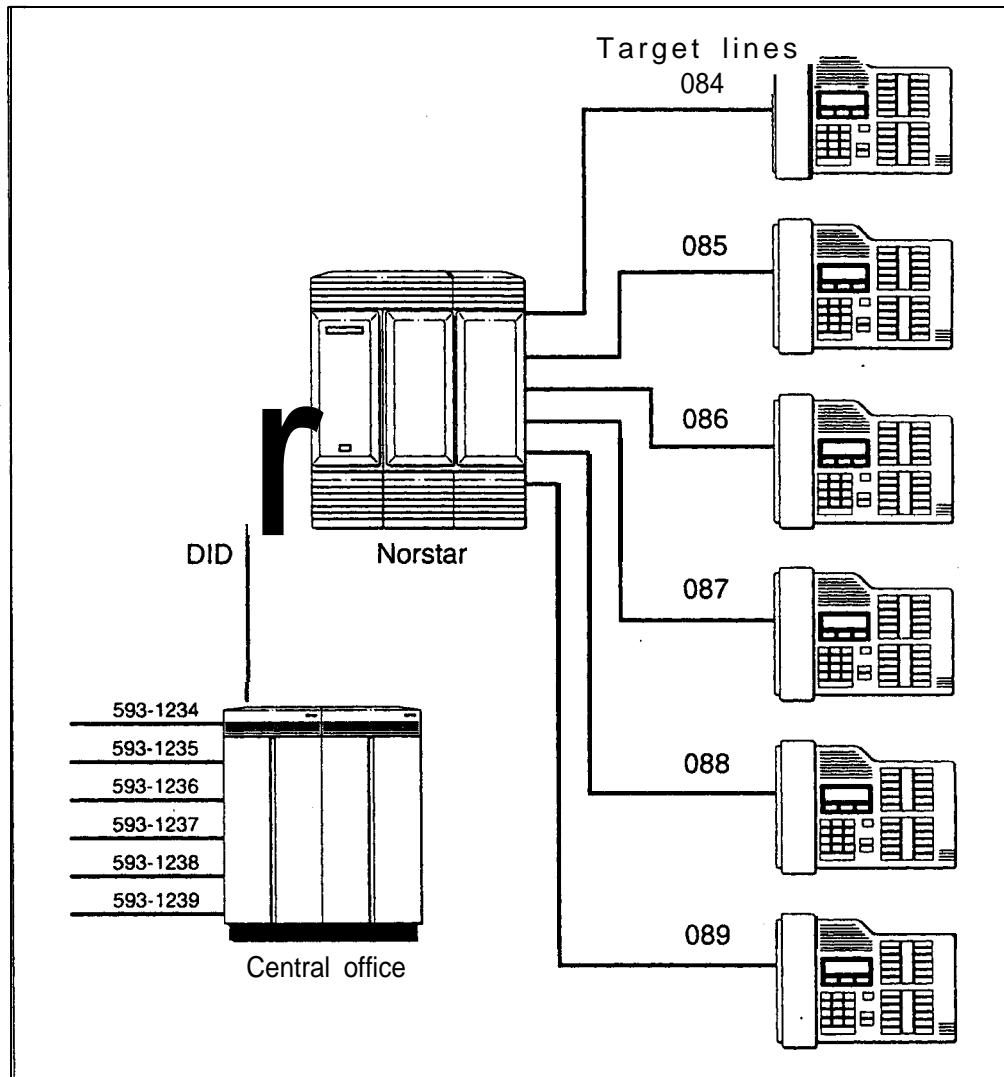

When a call comes in on a DID trunk, Norstar interprets the incoming digits:

- If the digits map onto a target line, Norstar routes the call to all Norstar devices with an appearance of that line.
- If the digits map onto the DISA DN, you hear a stuttered dial tone, after which you must use a DTMF telephone to enter a valid Class of Service password to get the system dial tone.
- If the digits map onto the Auto DN, or if the Class of Service password is valid, you hear the system dial tone. Then you can use a DTMF telephone to enter a target line number, a line pool access code, or a remote feature code.

Configuration requirements

You need one DID trunk cartridge for every four DID trunks. Each DID Trunk Cartridge has four DID trunks and four DTMF receivers dedicated to those trunks.

You cannot configure a DID trunk as the Prime line for a Norstar telephone.

Benefits

Security

In the Capabilities section of Administration programming, there are several ways of protecting your Norstar system from unauthorized access.

Class of Service

Class of Service refers to the capabilities that Norstar provides to users who access the system from the public or private network. The Class of Service includes:

- filters that restrict dialing on the line, and
- an access package, which defines the set of line pools that may be accessed and whether or not the user has access to the paging feature.

The Class of Service that is applied to an incoming remote-access call is determined by:

- the filters that you apply to the incoming trunk, or by
- the Class of Service password that the caller used to gain access to the Norstar system.

In cases where DISA is not applied to incoming calls, the remote caller can change the Class of Service by dialing the DISA DN and entering a Class of Service password.

To program Class of Service passwords, see Administration in the Programming chapter.

Dialing filters

You can use dialing filters to restrict the numbers that may be dialed on any external line within your Norstar system. You may specify up to 100 dialing filters for the system. A dialing filter consists of up to 48 restrictions and their associated exceptions.

Dialing within the system

To restrict dialing within the system, you can apply dialing filters to outgoing external lines (as line filters), to telephones (as set filters), and to external lines on specific telephones (as line per set filters).

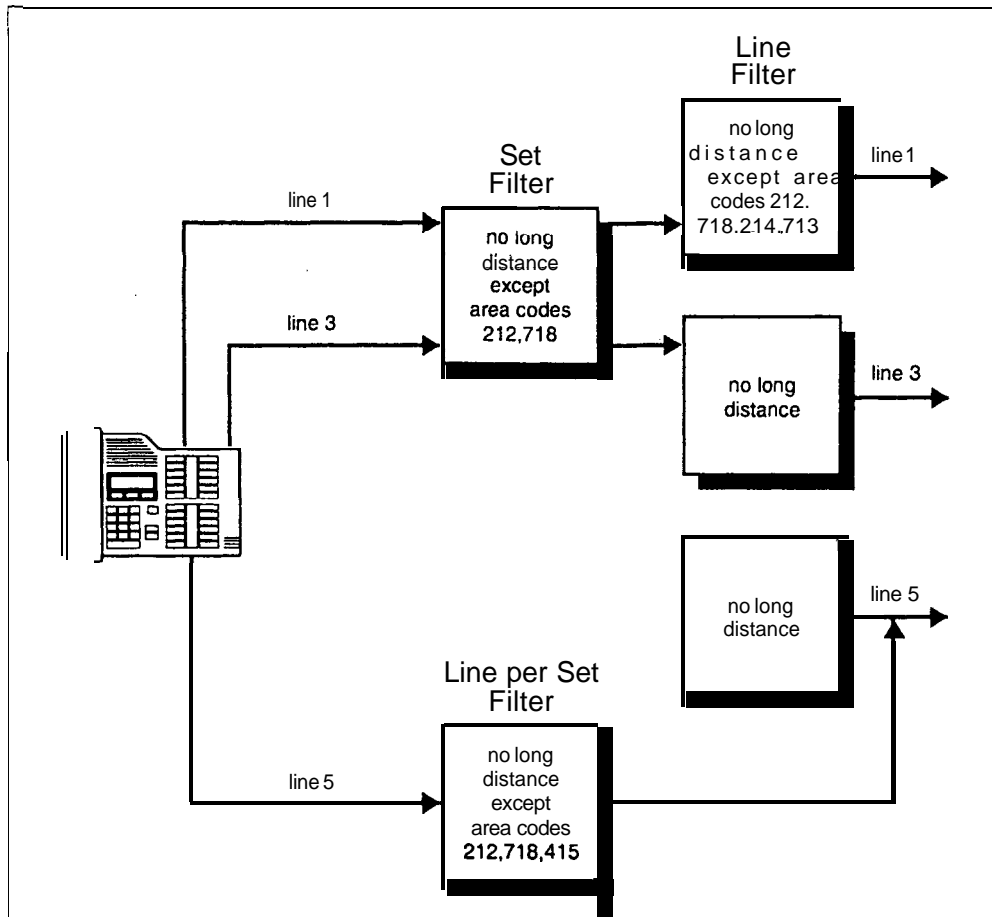

Dialed digits must pass both the line filter and the set filter. The line per set filter overrides the line filter and set filter.

In this diagram, a caller using line 1 could only dial long-distance numbers to area codes 212 and 718. A caller using line 3 could not dial any long-distance numbers. A caller using line 5 could dial long-distance numbers to area codes 212, 718, and 415.

Note: Set filters have no effect on the numbers that are dialed on an E&M trunk.

Dialing outside the system

To restrict dialing outside the system (once a caller gains remote access), you can apply dialing filters to incoming external lines (as remote filters).

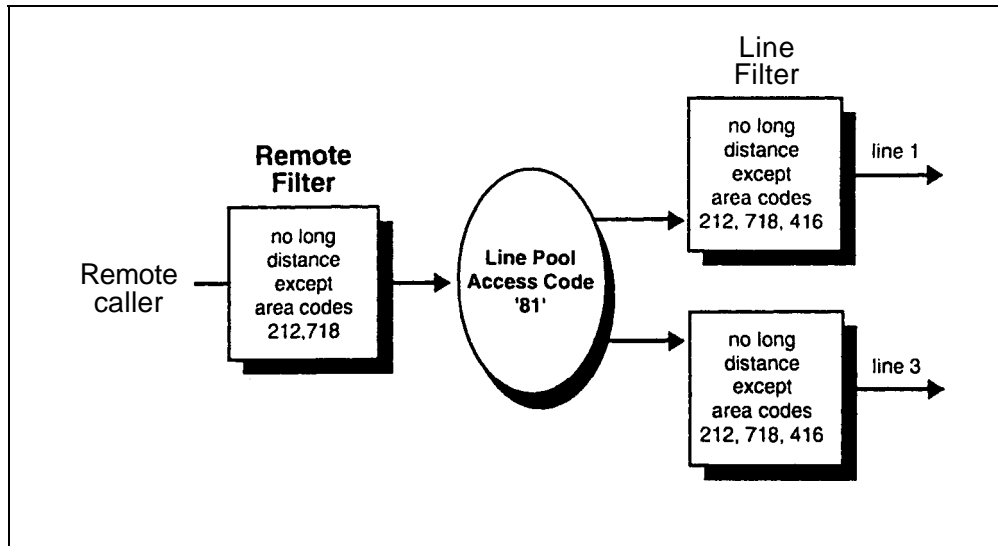

In this case, dialed digits must pass both the remote filter and the line filter. A remote caller can override these filters by dialing the DISA DN and entering a Class of Service password.

For programming instructions, see the Programming chapter of this Installer Guide.

Direct inward system access (DISA)

To control access from the public or private network, you can configure auto-answer trunks to answer with DISA. Remote callers hear a stuttered dial tone and must then enter a Class of Service password that determines what they are allowed to do in the system.

Auto-answer loop start and E&M trunks are configured to answer with DISA by default.

Note;’ You must have one E&M/DISA Trunk Cartridge for every two auto-answer loop start trunks.

DID trunks cannot be configured to answer with DISA. If you want incoming DID calls to be answered with DISA, configure the system with a DISA DN. Incoming DID calls that map onto the DISA DN are then routed to a line that has DISA.

For programming instructions, see the Programming chapter of this Installer Guide.

Unified dialing plan

The Norstar system does not support a coordinated dialing plan for other systems in the network. However, if you are configuring more than one Norstar system in your network, you can make access between the systems much easier with a unified dialing plan.

Directory Numbers

Make sure that the length of your DNs is the same for all the Norstar systems.

Line pools

If the Norstar systems are close to each other geographically, you can conserve resources by not duplicating access. For example, system A has a line pool to New York, System B has a line pool to Los Angeles, and system C has a line pool to Dallas. A Norstar user in system A calls system C to get the line pool to Dallas.

Line pool access codes

To simplify access between Norstar systems, all line pools that go to the same destination should have the same line pool access code. For example, system A and system B both have a line pool to London. You can configure both systems with the same line pool access code for the Nashville line pool.

Unified dialing plan among four systems

A dialing plan similar to the one in the following figure will let you create a company directory that includes the line pool access codes.

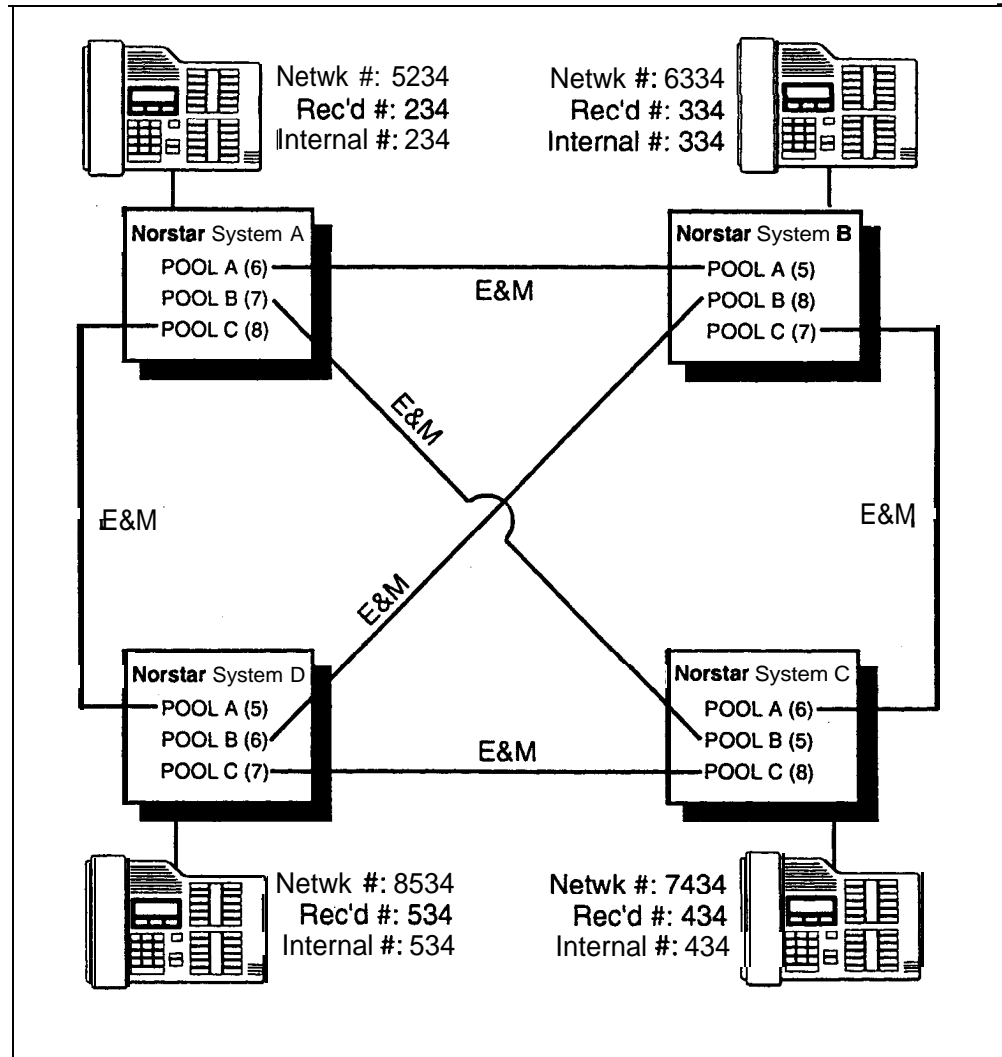

For instance, the person on System A at telephone 234 can select an Intercom button and dial 7434.

This means that telephone 234 has dialed the line pool access code of the trunk to System C, and will receive the dial tone of System C. The digits 434 then map to the Received number 434, and ring telephone 434 with an appearance of the associated target line.

Call handling with target lines

Having target lines with the Norstar system means that call coverage is extended. All call handling features that apply to regular lines also apply to target lines.

Here are some brief descriptions of features that apply to any line appearance on a Norstar telephone. For complete information on these features, see the Telephone features chapter of this 'Installer Guide.

Auxiliary Ringing

If the Norstar system has an auxiliary ringer (a bell that is not part of a telephone), the target line can be administered so that the auxiliary ringer alerts in addition to the telephone ringer.

Callback

When an external call on a target line is transferred to a busy telephone or not answered after a specified number of rings, the call automatically rings at the Prime telephone for that line. The display shows that the telephone was busy or that the call was not answered.

Camp on

Even when a telephone is busy, a call on a target line can be routed to the telephone, where it waits in a queue until the telephone is not busy.

Delayed Ring Transfer

Target line calls that go unanswered after a specified number of rings can be routed to the Prime telephone if programmed to do so in Configuration.

Held Line Reminder

When a target line call is placed on hold, the telephone gives two reminder tones at periodic intervals until the call is taken off hold. This happens only if Held reminder is activated during Configuration programming.

Overflow Call Routing

If a call comes in for a target line that is busy, Norstar routes the call to the Prime telephone for that target line. If you don't assign a Prime telephone for the target line or if a call cannot be mapped onto a target line, the call will go to the Prime telephone for the incoming trunk.

Prime Telephone Call Capture features

See the Prime Telephone User Card for details.

Privacy

When a Norstar user is on an external call and the Privacy feature is turned on, no other Norstar telephone with the same target line can join in on the call. If Privacy is turned off, another person with the same line can press the line button to join your conversation, forming a conference.

Service Modes

When there are fewer people available to answer calls during lunch hours, nights, or weekends, you can administer the system so that target line calls ring at certain telephones.

Customer Use

This section shows sample configurations for different types of network access. Each example has four parts:

- A scenario explains the caller's goal and what is required to achieve it.
- A diagram shows the network configuration that supports the application.
- A list shows the Norstar hardware required to support the configuration.
- Tables show the Configuration and Administration programming required. Only those settings that are important to network access are described here.

In the public network

Call one or more **Norstar** telephones

Ms. Nelson is a bank customer who has a question for an accountant. She dials the telephone number that maps onto target line 083. All of the accountants' telephones ring.

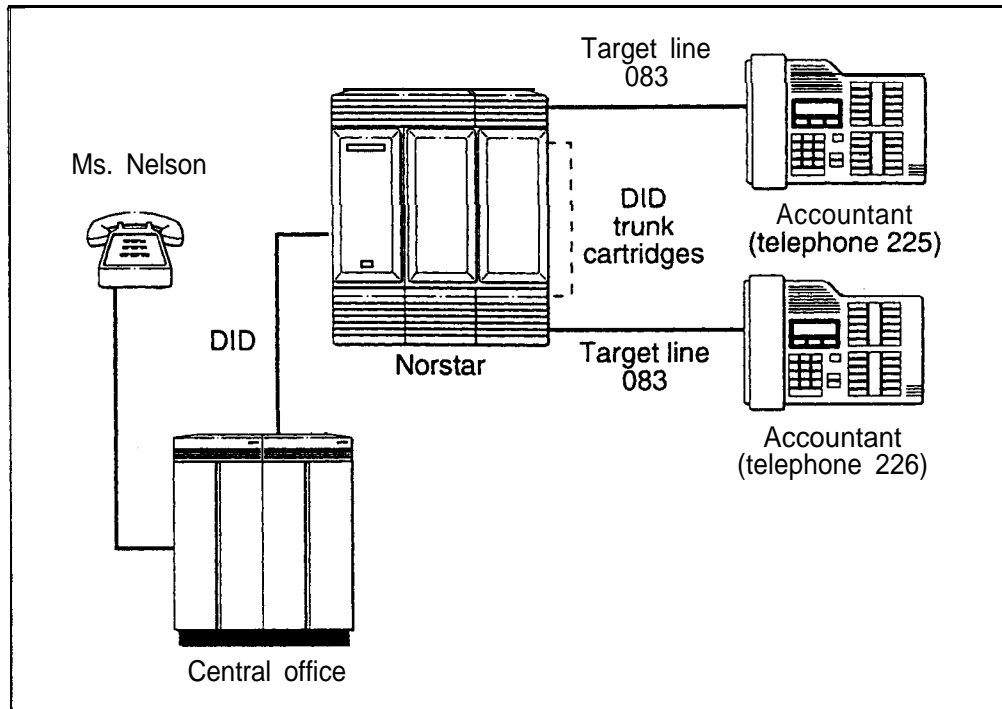

Hardware: any version of KSU, one Trunk Module, one DID Trunk Cartridge.

Heading	Parameter	Setting
1. Trk/Line Data	Rec'd # Line 009	4321 (for Line 083) DID
5. System Data	Rec'd # length	4 (can be up to 7 digits, but must match number of digits sent by Central Office)

Call **Norstar** and select tie lines to a private network

A manager in Georgia wants to use the tie lines at headquarters to call Washington. He dials a telephone number that maps onto the DISA DN, enters a Class of Service (COS) password, then dials a line pool access code to select a tie line to Washington.

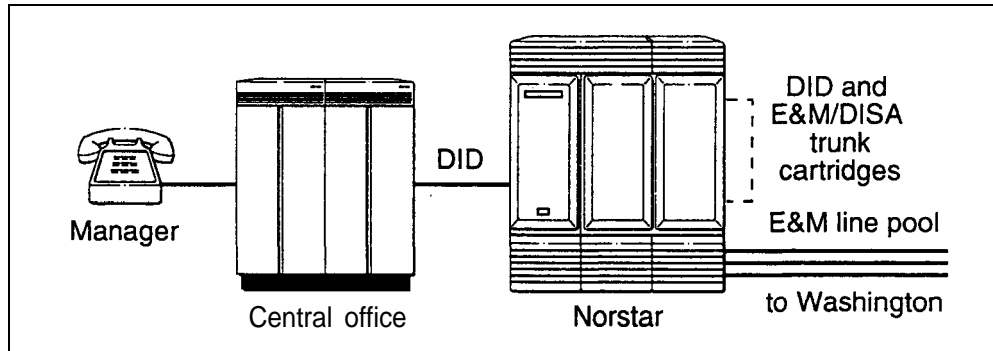

Hardware: any version of KSU, one Trunk Module, one DID Trunk Cartridge, two E&M/DISA Trunk Cartridges (for the three trunks in the line pool to Washington).

Heading	Parameter	Setting
Incoming trunk:		
1. Trk/Line Data	Line 009	DID
4. Miscellaneous	DISA DN	5321
5. System Data	Rec'd # length	4 (can be up to 7 digits, but must match number of digits sent by Central Office)
Outgoing trunk:		
1. Trk/Line Data	Line 013 Line type	E&M Pool F
4. Miscellaneous	Line pool F	6 (up to 4 digits)
5. Capabilities		Define filters: Define remote access pkgs. Assign a dialing filter to the line. Assign COS passwords and filters for each class of service.

Call **Norstar** and select lines to the public network

Gord wants to make a long-distance business call from home. To avoid being charged, he dials the telephone number that maps onto the Auto DN at work. After hearing the dial tone, Gord dials a line pool access code to select a line to the public network. He then dials the long-distance number.

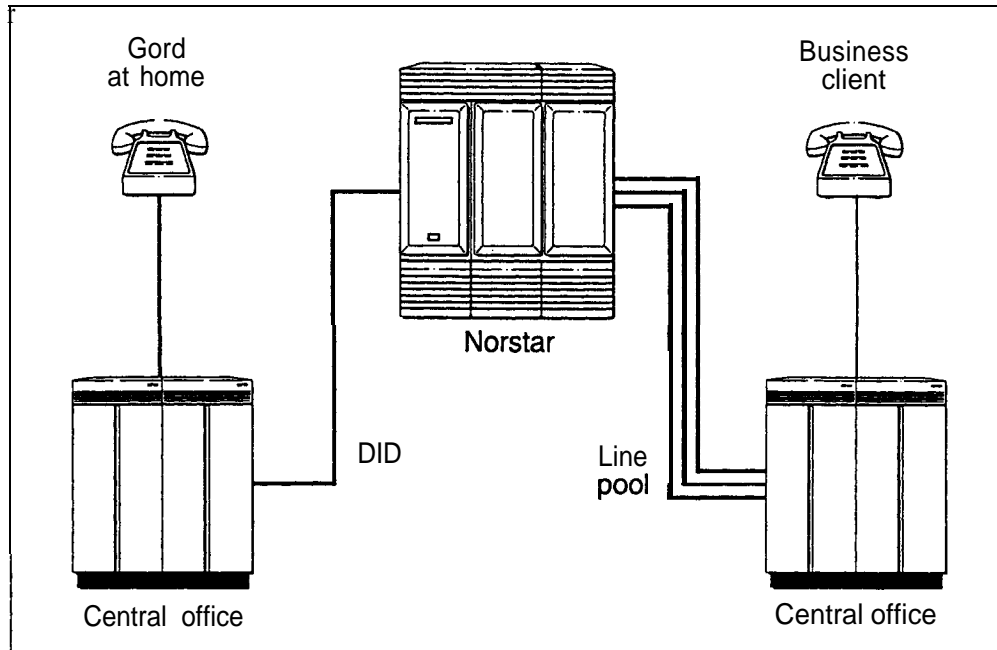

Hardware: any version of KSU, one Trunk Module, one DID Trunk Cartridge.

Heading	Parameter	Setting
Incoming trunk:		
1. Trk/Line Data	Line 009	DID
4. Miscellaneous	Auto DN	4321
5. System Data	Rec'd # length	4 (can be up to 7 digits, but must match number of digits sent by Central Office)
5. Capabilities		Define dialing filters. Define remote access packages. Assign a remote filter and remote package to the line.
Outgoing trunk:		
1. Trk/Line Data	Line 001 Line type	Loop Pool A
4. Miscellaneous	Line pool A	1234
5. Capabilities		Assign a dialing filter to the line.

In the private network

Call one or more **Norstar** telephones

The production supervisor in Houston selects the less-expensive company tie line to call the manager at the Administration office in Dallas. Once the line is selected, the production supervisor dials the digits that will map onto the target line of the manager in Dallas.

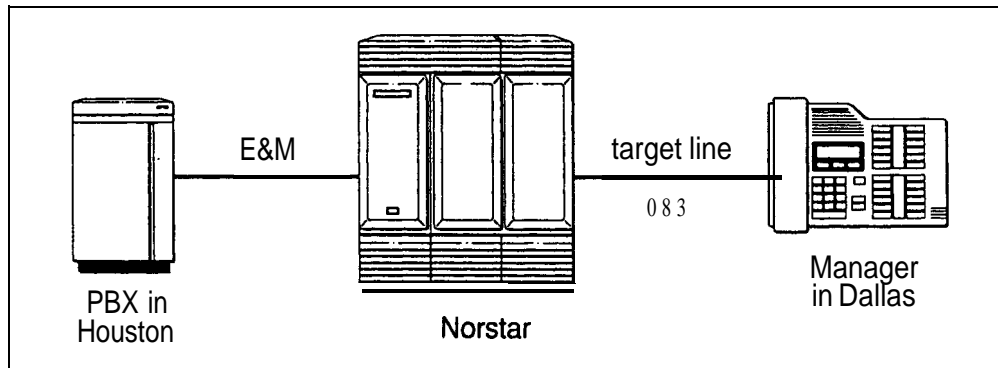

Hardware : any version of KSU, one Trunk Module, one E&M/DISA Trunk Cartridge.

Heading	Parameter	Setting
incoming trunk:		
1. Trk/Line Data	Rec'd #	4321 (for target line 083)
	Line 009	E&M
	Ans Mode	Auto
5. System Data	Rec'd # length	4 (can be up to 7 digits, but must match number of digits sent by Central Office)

Call **Norstar** and select tie lines to other nodes in the private network

At a branch office, Joan selects a tie line to the government office downtown. After hearing the dial tone, she dials a line pool access code to select another tie line to a government office in the next town.

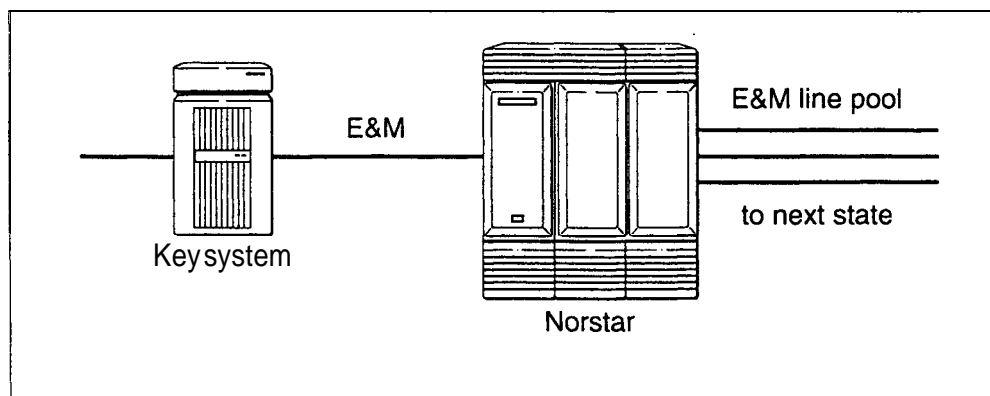

Hardware: any version of KSU, one Trunk Module, two E&M/DISA Trunk Cartridges (for the three lines in the line pool and the one incoming line)

Heading	Parameter	Setting
Incoming trunk:		
1. Trk/Line Data	Line 009 Ans mode	E&M Auto
5. Capabilities		Define dialing filters. Define remote access packages. Assign a remote line filter and remote package to the trunk.
Outgoing trunk:		
1. Trk/Line Data	Line 010 Line type	E&M Pool D
4. Miscellaneous	Line pool D	71 (up to 4 digits)
5. Capabilities		Assign a dialing filter to the trunk.

Call **Norstar** and select lines to the public network

Liz needs to call long-distance to a client in Toronto. She selects a tie-line to the branch office in Toronto. After hearing the dial tone, she dials a line pool access code to select a line to the public network. Then, she dials the client's number as a local call.

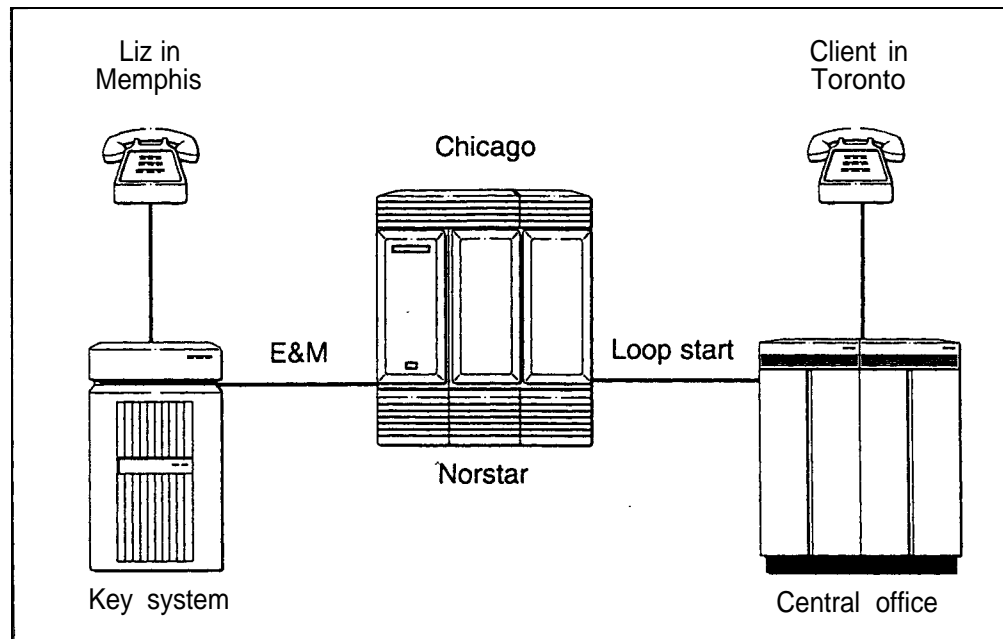

Hardware: any version of KSU, one Trunk Module, one E&M/DISA Trunk Cartridge.

Heading	Parameter	Setting
Incoming trunk:		
1. Trk/Line Data	Line 009 Ans mode	E&M Auto
5. Capabilities		Define dialing filters. Define remote access packages. Assign a remote filter and remote package to the trunk.
Outgoing trunk:		
1. Trk/Line Data	Line 001 Line type	Loop Pool B
4. Miscellaneous	Line pool B	73 (up to 4 digits)
5. Capabilities		Assign a dialing filter to the line.

In the **Norstar** system

Select tie trunks to the private network

- . For a confidential call, the Montana sales manager presses the line button for a private E&M trunk to the Oregon office. This automatically alerts at the line appearance on the telephone of the Oregon sales manager.

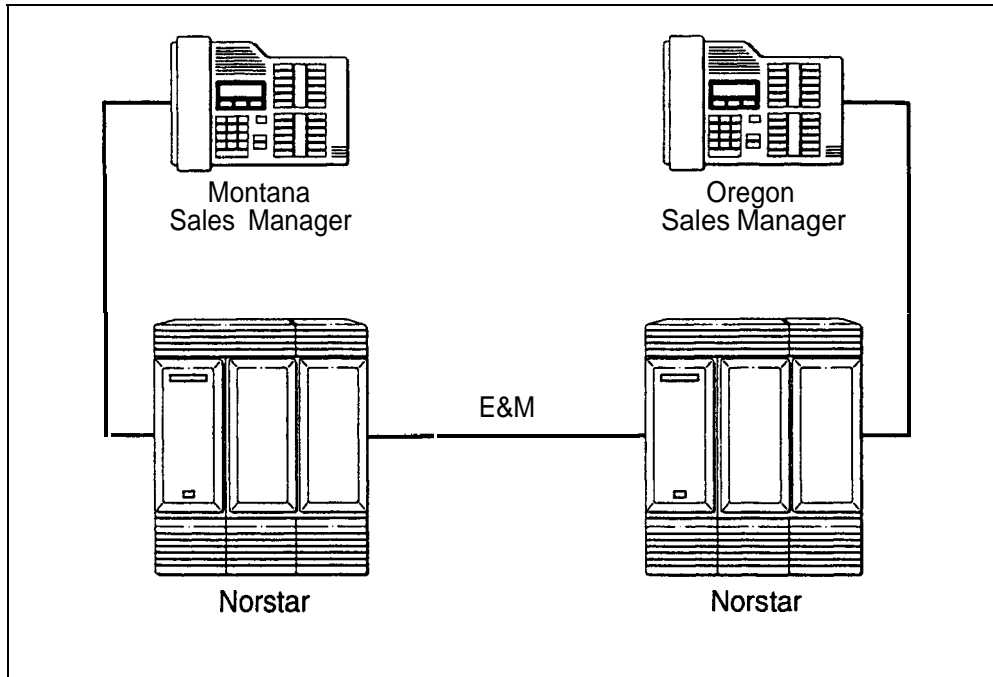

Hardware: (for both systems) any version of KSU, one Trunk Module, one E&M/DISA Trunk Cartridge

Heading	Parameter	Setting
Outgoing trunk (Montana):		
Trunk Data (Line 009)	Line	E&M
Line Data (Line 009)	Line type	Private
Incoming trunk (Oregon):		
Trunk Data (Line 009)	Line	E&M
	Ans mode	Manual
	Line type	Private

A Norstar System Feature

Line Redirection feature

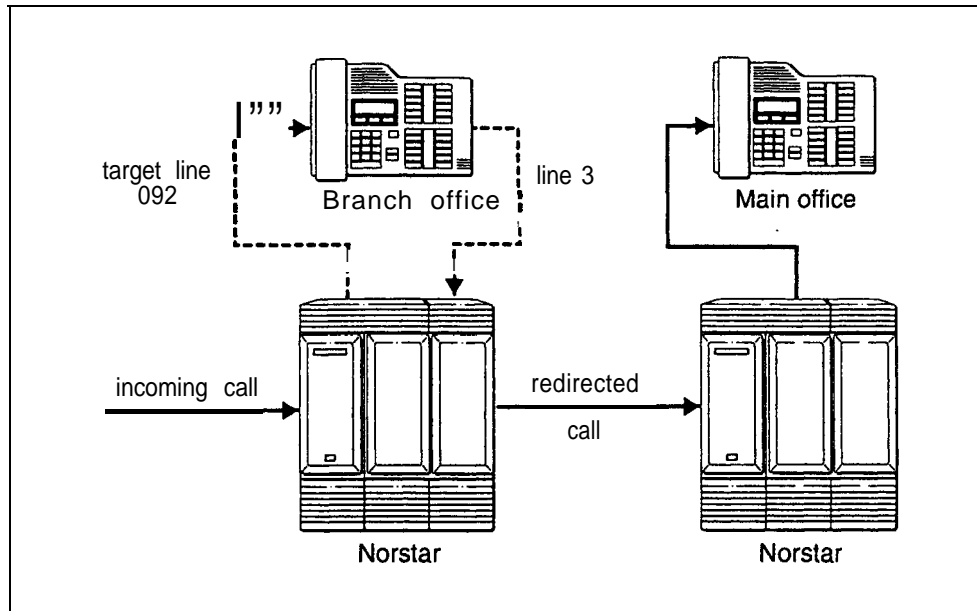

The branch office is receiving more calls than it can handle, so it redirects one of its lines to the main office. All calls that come in on target line 092 will be routed out on line 003 to the main office. Whenever a call is redirected, the target line and outgoing line will be busy for the duration of the call.

Hardware : Version 2 or higher KSU, an E&M/DISA Trunk Cartridge if the incoming trunk is E&M, or a DID Trunk Cartridge if the incoming trunk is DID.

Note: Any line appearance on a telephone can be selected as the incoming line to be redirected. A target line can not be selected as the outgoing line for redirection.

Note: The incoming trunk must have disconnect supervision.

Program heading	Setting
Incoming trunk:	
1. Trk/Line Data	Line001:Loop Trunk mode:Super Ans mode:Auto OR Line 009:DID OR Line 013:E&M Ans mode:Auto
5. System Data	Rec'd#:4321 (for target line 092) Rec'd # length:4 (can be up to 7 digits, but must match number of digits sent by Central Office)
Outgoing trunk:	
1. Trk/Line Data	Line 003: Loop OR Line01 4:E&M
Branch office set:	
5. Capabilities	Allow redirect:V

Installation

Check the location where the Norstar system modules, the telephones, and auxiliary equipment are to be installed. This includes making sure sufficient space is available to install the components.

Location requirements

- Clean, dry, and well-ventilated
- Temperature: 0°C to 50°C (32°F to 122°F)
- Humidity: 5% to 95%, non-condensing
- Location: at least 4 m (13.1 ft) from equipment such as photocopiers, electrical motors, and other equipment that can produce electromagnetic, radio frequency, and electrostatic interference.

Electrical requirements

- Non-switched outlet
- ac outlet located not more than 1.5 m (4.9 ft) from the Key Service Unit (KSU). The actual distance from the KSU to the Power Bar may vary with additional Trunk and Station Modules. Do not use an extension cord between the KSU and the power bar.

For the 110 V system

- Dedicated 110-V ac nominal, 50/60-Hz, 15-A minimum service with third wire ground.

For the 220 V system

- Dedicated 220- to 240-V ac nominal, 50/60-Hz, 10-A minimum service with third wire ground.

WARNING

The ac outlet must be equipped with a third wire ground to avoid electromagnetic interference.

Internal wiring requirements

All new or existing wiring for Norstar telephones must meet the following specifications:

- one twisted pair per telephone
- a dc loop resistance less than 59 Ω
- cable length (0.5 mm or 24 AWG) not to exceed 305 m (1000 ft)
- use of a Norstar Station Auxiliary Power Supply (SAPS) to extend the loop up to 790 m if the cable is longer than 305 m (1000 ft)
- no bridge taps

WARNING

Installers should also check the lightning protectors at the cable entry point to the building with special attention to the grounding. Any problems should be reported to the telephone company in writing. Norstar telephone wiring should not leave the buildings as it is not lightning-protected.

Mounting requirements

If a smooth surface is not available, cut a backboard large enough to accommodate the system modules and the distribution block. The system module physical dimensions are listed in this chapter.

Equipment for mounting the modules

- screwdriver, diagonal cutters, pliers, connecting tool, pencil, level (optional)
- four 1 9-mm ($3/4$ -in) long wood screws for the KSU and four for each of the expansion modules
- 38-mm (1 $5/8$ -in) long screws for the cable troughs
- 19-mm ($3/4$ -in) thick wooden backboard (if necessary)

Module installation

Key System Unit (KSU)

The Key Service Unit (KSU) is the hub of the Not-star System. It can function on its own as a basic system (with up to 24 Norstar telephones and eight external lines). The system may also be expanded with any combination of up to six Trunk Modules and/or Station Modules.

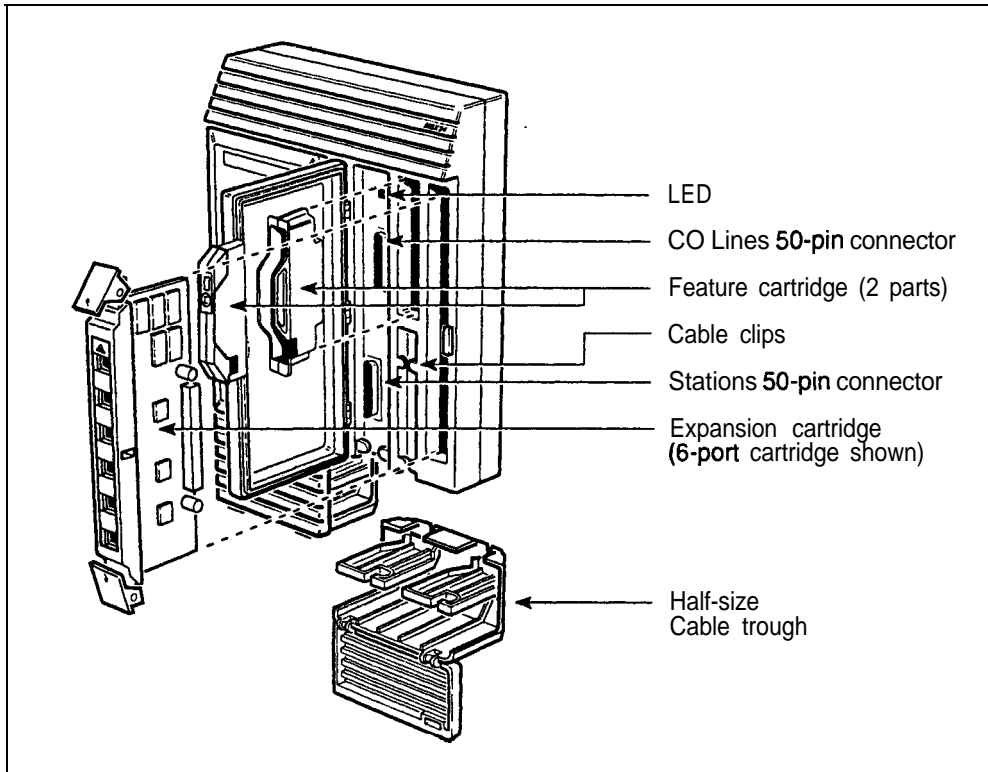

Trunk Module (TM)

The Trunk Module allows additional Trunk Cartridge installation. This in turn allows more external lines to be connected to the Norstar system. The Trunk Module has three slots in front for inserting Trunk Cartridges. Each Trunk Module can add a maximum of 12 external lines (four external lines per Trunk Cartridge). Different types of Trunk Cartridges can be mixed in one Trunk Module. When mixing Trunk Cartridges, use a separate distribution block for each type of Trunk Cartridge.

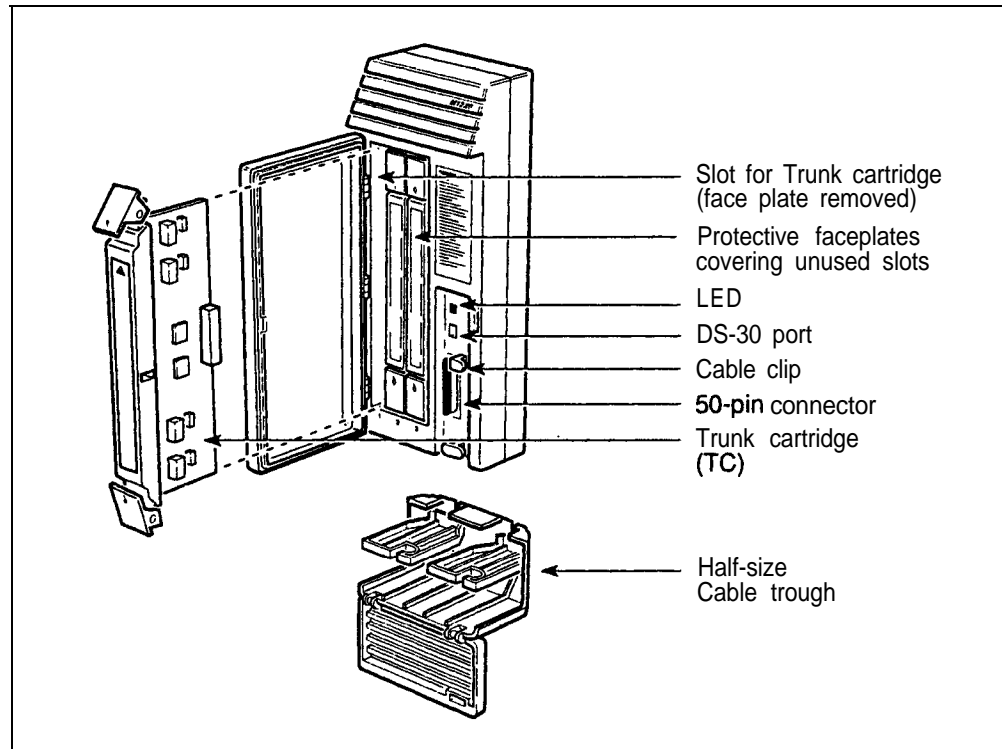

Station Module (SM)

The Station Module allows up to 16 additional Norstar telephones to be connected to the system. A DS-30 cable connects each Station Module to the KSU.

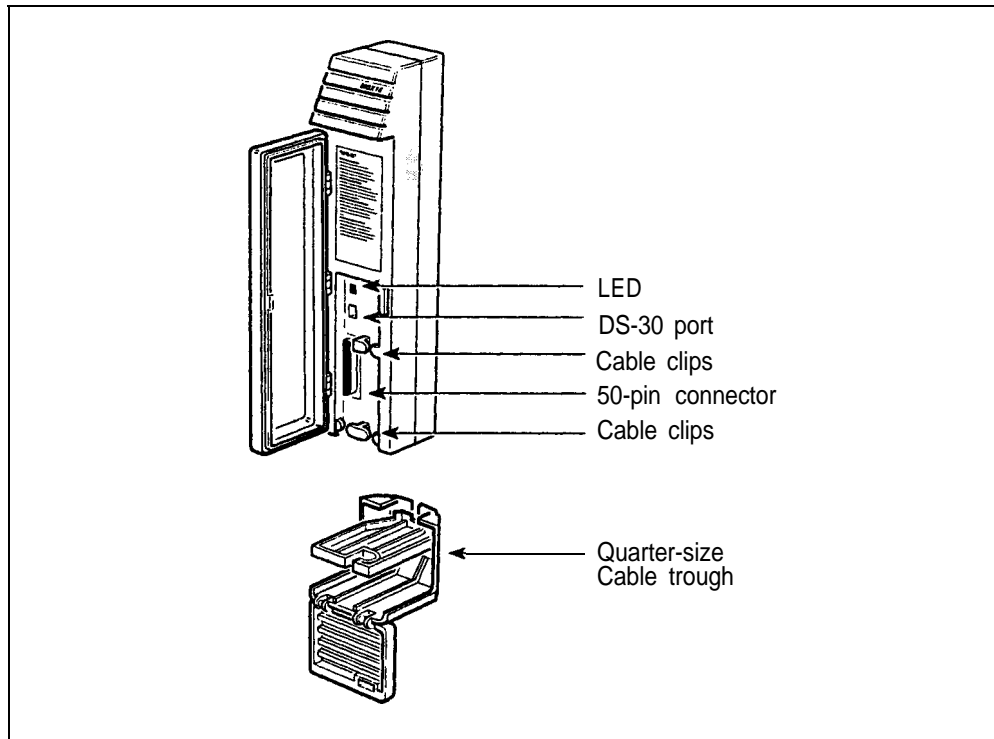

Recommended layout

The Key Service Unit (KSU), Trunk Modules (TM), and Station Modules (SM) can be mounted in any order. Allow suitable wall space for installing future Trunk and Station Modules.

System dimensions

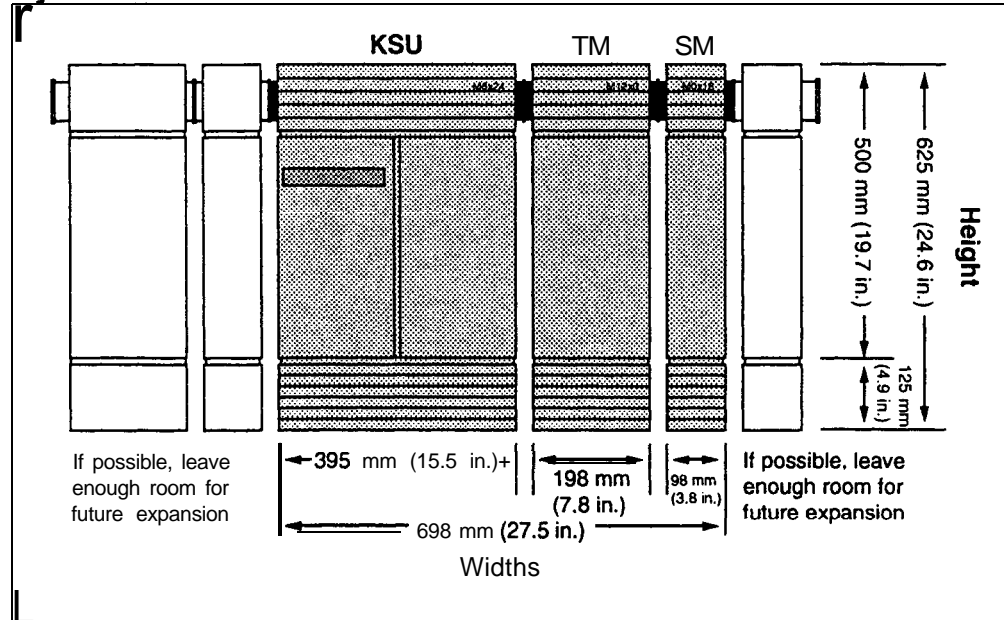

Additional dimensions of **Norstar** KSU, TM & SM

Dimension	KSU	TM	SM
Depth	171 mm (6.7 in)	171 mm (6.7 in)	171 mm (6.7 in)
Clearance (front)	346 mm (13.6 in)	346 mm (13.6 in)	245 mm (9.6 in)
Weight (excluding cables and cartridges)	7.5 Kg (16.6 lb)	4.3 Kg (9.5 lb)	2.4 Kg (5.3 lb)

Remember

Top

Leave about 15 centimetres (6 inches) of space above the screw holes of the mounting bracket. This allows room to slide the KSU, Trunk Module and Station Module on and off the bracket and provides space for venting the heat from the modules.

Bottom

Ensure there is at least 10 centimetres (4 inches) of space between the bottom of the cable trough and the floor, or any object that may block the flow of air from the bottom for cooling.

CAUTION

All modules must be mounted well above the floor to prevent water damage.

Sides

Mount the distribution block on the left side of the KSU. Leave enough room to mount additional Trunk Modules and Station Modules on the right side.

Front

Leave enough room to allow the doors of the modules to open and the cabling to run on the side.

Between modules

The space between two modules hung on the mounting brackets is approximately 3 mm (1/8 in).

Note: Refer to the illustration showing the system dimensions for additional module clearance requirements.

CAUTION

Mount the KSU vertically to avoid overheating.

System hardware configuration

This chart shows combinations of Trunk Modules, Trunk Cartridges, and Station Modules for expanding the system.

Possible line and station configurations

TM	TC	SM						
		0	1	2	3	4	5	6
0	0	8-24	8-40	8-56	8-72	8-88	8-104	8-120
1	1	12-24	12-40	12-56	12-72	12-88	12-104	
	2	16-24	16-40	16-56	16-72	16-88	16-104	
	3	20-24	20-40	20-56	20-72	20-88	20-104	
2	4	24-24	24-40	24-56	24-72	24-88		
	5	28-24	28-40	28-56	28-72	28-88		
	6	32-24	32-40	32-56	32-72	32-88		
3	7	36-24	36-40	36-56	36-72			
	8	40-24	40-40	40-56	40-72			
	9	44-24	44-40	44-56	44-72			
4	10	48-24	48-40	48-56				
	11	52-24	52-40	52-56				
	12	56-24	56-40	56-56				
5	13	60-24	60-40					
	14	64-24	64-40					
	15	68-24	68-40					
6	16	72-24						
	17	76-24						
	18	80-24						

Note: Number of physical lines shown is for Loop Start, DID, and CI Trunk Cartridges only. E&M/DISA Trunk Cartridges provide half the number of lines.

How to read the hardware chart

To find the maximum number of lines and telephones for a particular configuration of KSU, Trunk Module(s), and Station Module(s):

1. Find the number of Trunk Modules in the left column. The column labeled "TC" gives the number of Trunk Cartridges.
2. Find the number of Station Modules in the top row.
3. Read across to the right from the Trunk Module column and down from the Station Module row.

A pair of numbers indicates lines and telephones for that combination of Trunk Modules and Station Modules. The left number is the maximum number of external lines. The right number is the maximum number of telephones.

Examples:

8-24	=	8 lines and 24 telephones (KSU without Trunk Modules or Station Modules).
------	---	---

12-24	=	12 lines and 24 telephones (KSU lines and telephones, plus one Trunk Module and one Trunk Cartridge with 4 more lines, and no Station Modules).
-------	---	---

12-40	=	12 lines and 40 telephones (KSU lines and telephones, plus one Trunk Module and one Trunk Cartridge with 4 more lines, and one Station Module with 16 more telephones).
-------	---	---

Mounting a module

1. Position metal mounting bracket(s) on the wall or on the backboard. Fasten the brackets with 19-mm (³/₄ in) screws.

Hint: Before positioning the mounting brackets, draw a line using a level and a pencil. This will help align the modules.

2. Slide the KSU, Trunk Module, or Station Module down onto the mounting brackets. Line up with the notches on either side of the mounting bracket as you slide the module onto the mounting bracket(s). This facilitates accurate hanging.
3. Slide the cable trough(s) up under the appropriate module(s).
The KSU requires two half-size cable troughs. A Trunk Module uses one half-size cable trough, while an Station Module uses a quarter-size cable trough.
4. Open each cable trough door and let the door swing open.
5. Fasten the cable trough to the wall with 25-mm long screws. Each cable trough requires two screws through the holes provided in the lower tray of the cable trough.
6. Close the doors of the cable troughs.
7. Do not connect power at this point.

Installing the KSU mounting bracket

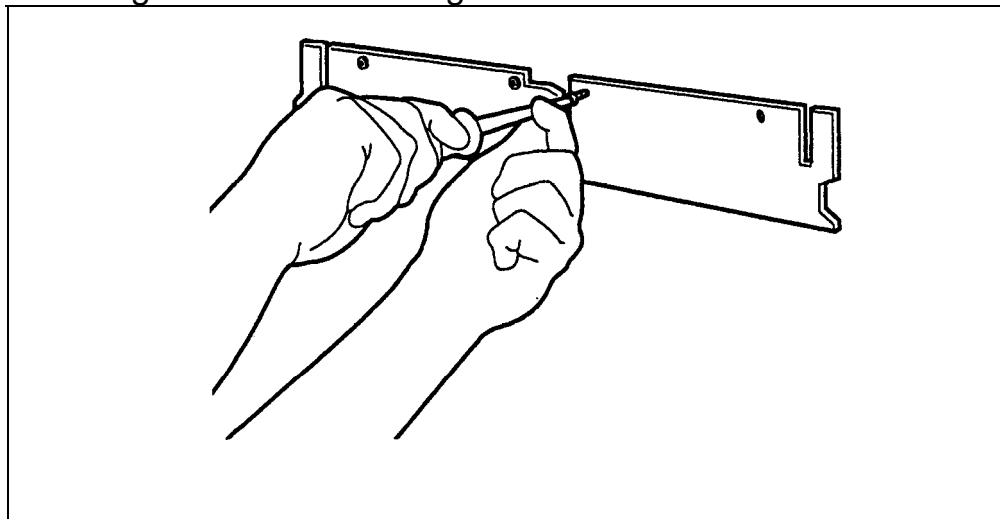

Hanging the KSU

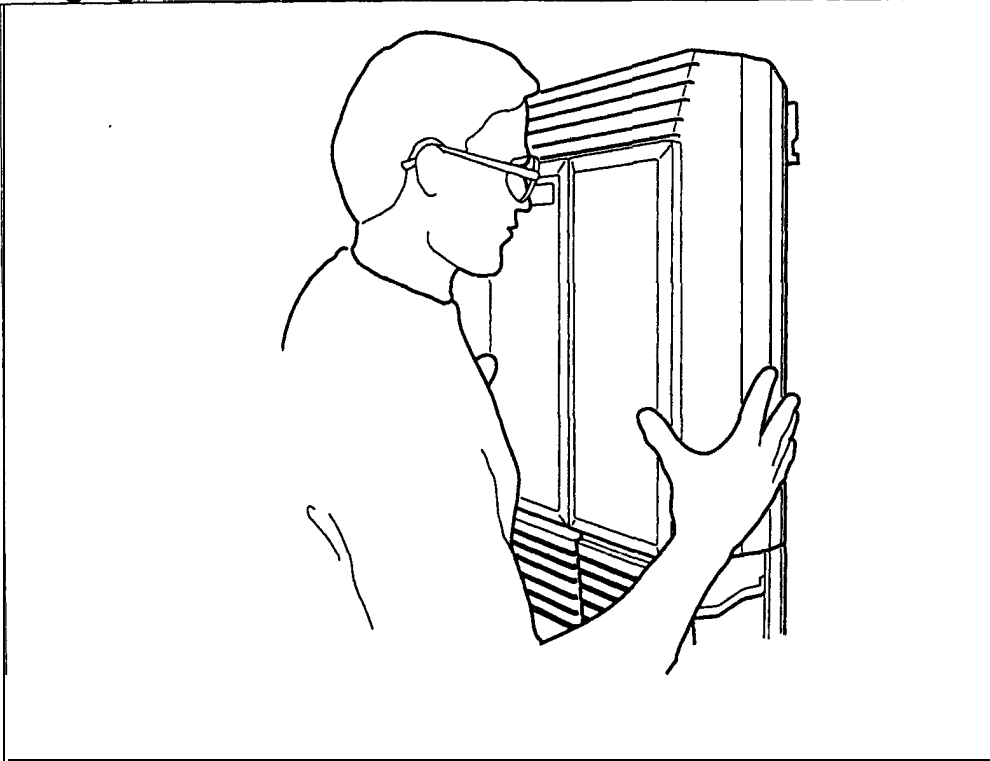

Installing the cable troughs

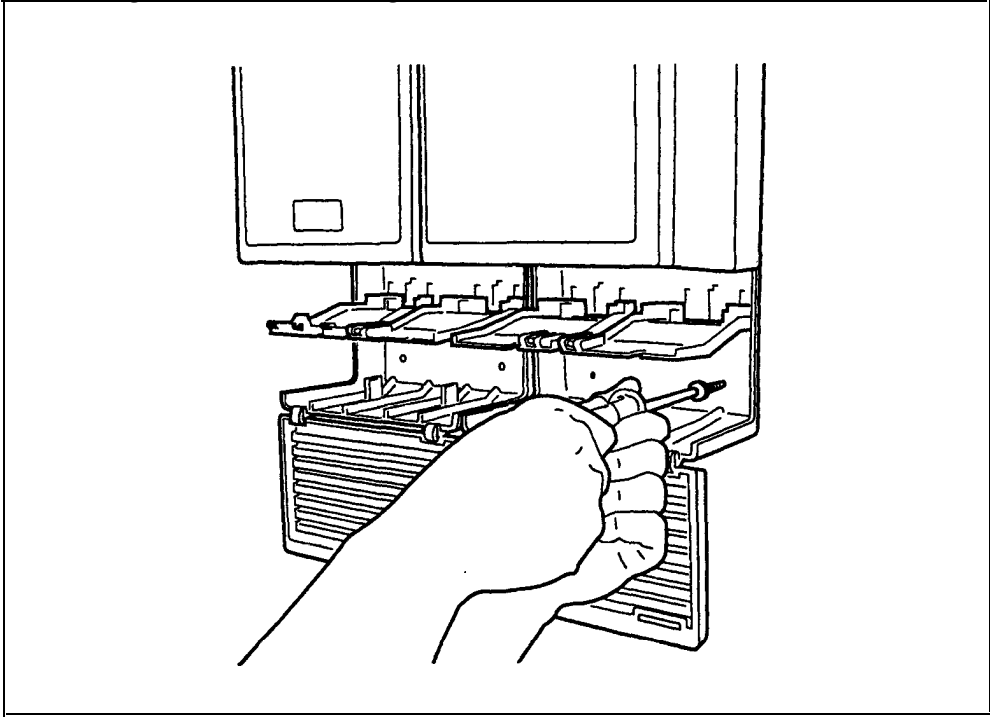

KSU, Trunk Module, and Station Module installed

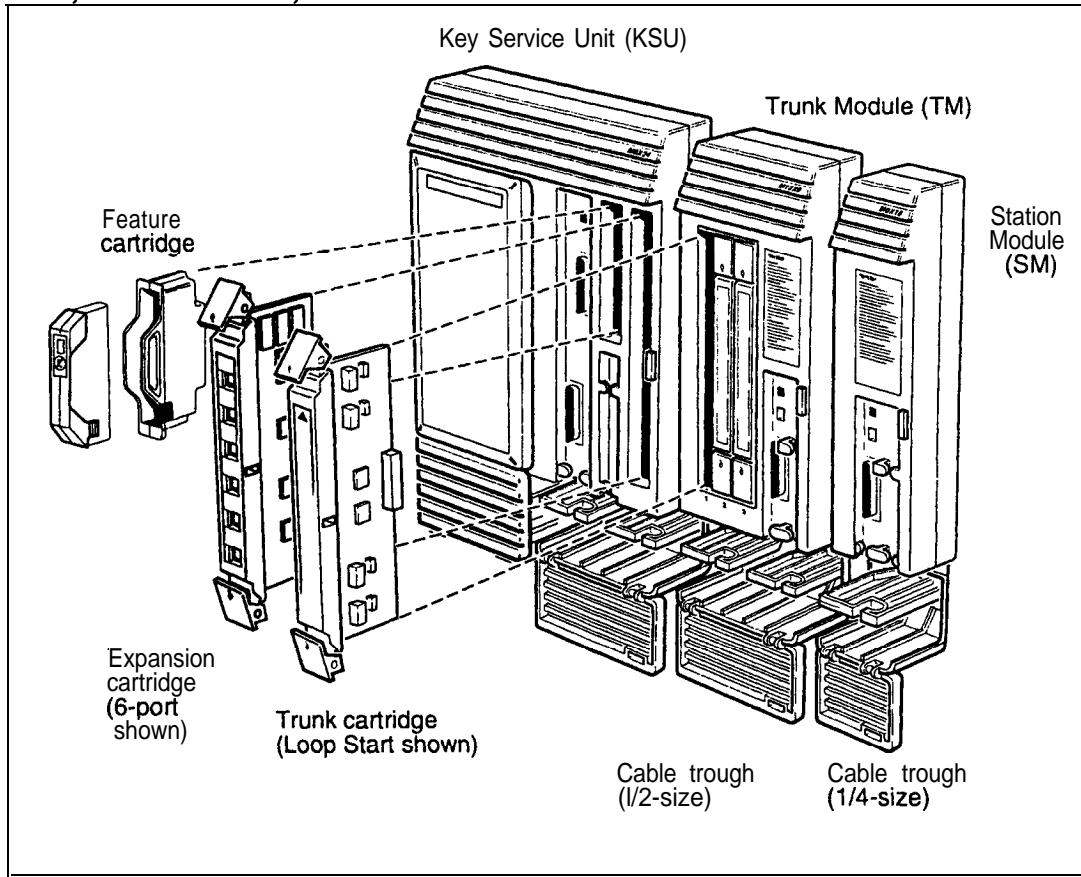

Note: For clarity, the illustration shows a KSU, a Trunk Module, and an Station Module without doors. The doors should not be removed during installation or operation. Also shown are the Feature, Expansion, and Trunk Cartridges which are installed later.

Installing the Feature Cartridge

The Feature Cartridge is made up of a Software Cartridge and a Data Cartridge. The Software Cartridge contains the system programming. The Data Cartridge contains the data from Configuration and Administration programming.

When there is a software upgrade, only the Software Cartridge, and not the Data Cartridge, needs to be replaced.

CAUTION

Do not touch the printed circuit board inside the cartridge casing. This is an electrostatic-sensitive device.

1. Turn the KSU power OFF before installing or removing a Feature Cartridge.
2. Make sure you are wearing a grounding strap when handling Norstar cartridges.
3. Insert the Software Cartridge into the Data Cartridge.
4. Insert the Feature Cartridge assembly into the KSU.

Unassembled and assembled Feature Cartridges

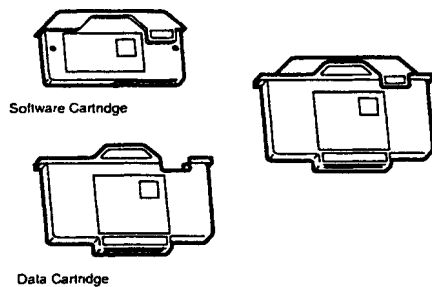

Installing the Feature Cartridge

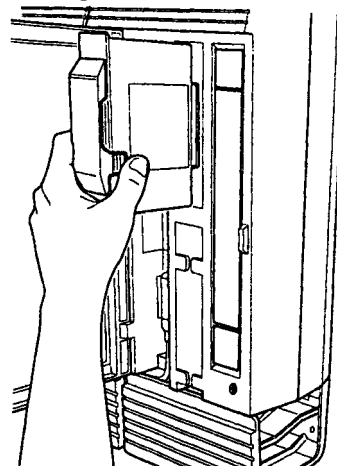

Installing an Expansion Cartridge

The two-port Expansion Cartridge allows up to two additional modules (Trunk Modules and/or Station Modules) to be connected to the system. The six-port Expansion Cartridge allows the connection of up to six additional Trunk or Station Modules. This Cartridge fits into the right slot of the Key Service Unit (KSU).

Two-port Expansion cartridge

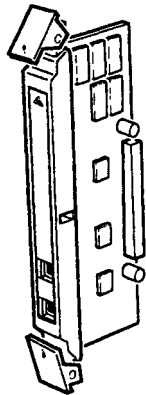

Six-port Expansion cartridge

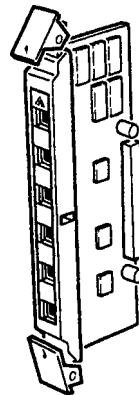

The procedures for installing the Two-port and Six-port Expansion Cartridges are identical. (Refer to the Port Numbering information in this Guide for changes to default internal number length caused by installing an Expansion Cartridge.)

CAUTION

Do not touch the printed circuit board on the Expansion Cartridge. This is an electrostatic-sensitive device.

1. Make sure that the KSU power is OFF before installing or removing an Expansion Cartridge.

2. Remove the cover of the Expansion Cartridge slot in the KSU. Use a screwdriver at the bottom of the cartridge slot cover to help detach the cartridge slot cover from the slot.

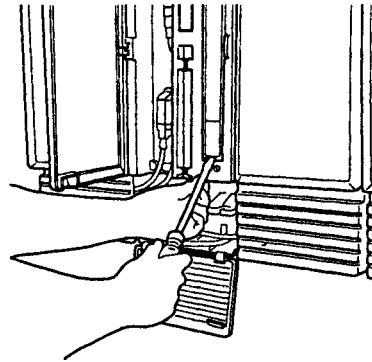

3. Make sure you are wearing a grounding strap when handling any cartridge.

4. While holding the latches open, insert the Expansion Cartridge in the appropriate slot and close the latches at the same time to align the cartridge properly.

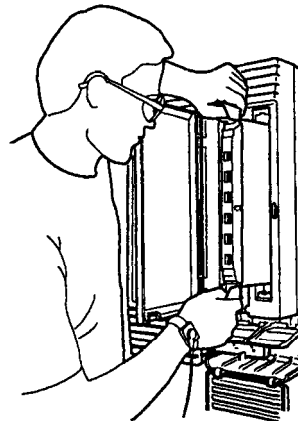

Installing a Trunk Cartridge

The Trunk Cartridge, when inserted in a Trunk Module, adds up to four external lines to the Norstar system. A maximum of three Trunk Cartridges can be installed in each Trunk Module.

There are four types of Trunk Cartridges:

- the Loop Start Trunk Cartridge (4 lines)
- the E&M/DISA Trunk Cartridge (2 lines)
- the DID Trunk Cartridge (4 lines)
- the CI Trunk Cartridge (4 lines)

The Loop Start Trunk Cartridge supports regular external lines. The E&M/DISA Trunk Cartridge connects **Norstar** to a private network. The DID Trunk Cartridge supports direct inward dialing on incoming external lines. The CI Trunk Cartridge supports Call Display features on external lines.

Trunk Cartridges

Loop Start

E&M/DISA

DID

CI

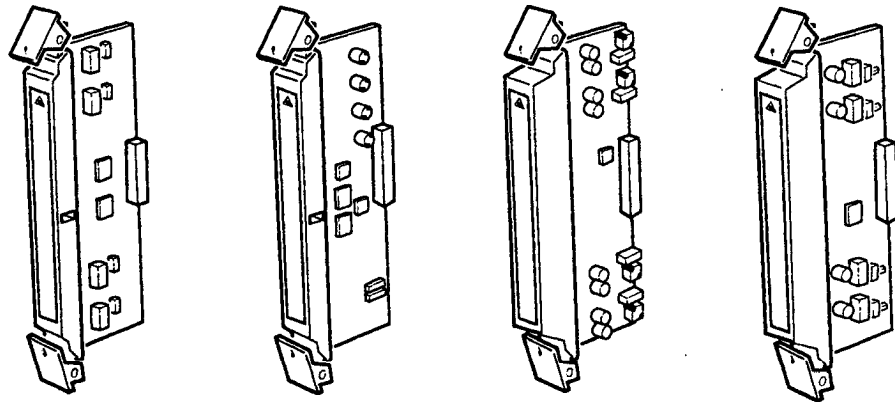

Different Trunk Cartridges can be installed in one Trunk Module if required for a particular installation. When mixing Trunk Cartridges, use a separate distribution block for each type of Trunk Cartridge.

The procedures for installing the different Trunk Cartridges are identical. See the wiring charts in this Guide for details.

CAUTION

Do not touch the printed circuit board on the Trunk Cartridge. This is an electrostatic-sensitive device.

1. Make sure that the Trunk Module power is OFF before installing or removing a Trunk Cartridge.
2. Remove the appropriate cartridge slot cover of an unused Trunk Cartridge slot on the Trunk Module. Use a screwdriver at the bottom of the cartridge slot cover to detach the cover from a Trunk Cartridge slot.

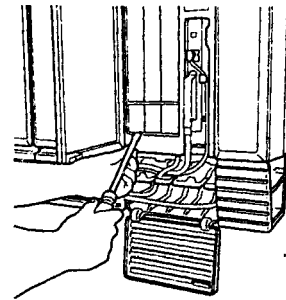

Note: The numbers on the cartridge slots indicate the order that the cartridges should be installed. If an E&M/DISA or a DID Trunk Cartridge is installed in slot 1, Emergency telephones cannot be supported.

3. Make sure you are wearing a grounding strap when handling Norstar cartridges.
4. While holding the latches open, insert the Trunk Cartridge in the appropriate slot and close the latches at the same time to align the cartridge properly.

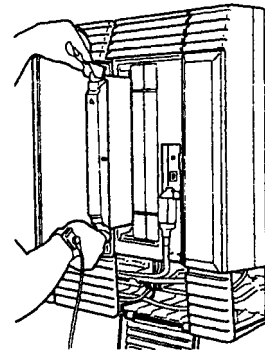

Upgrading the Software Cartridge

Before installing a Modular DR5 CI Trunk Cartridge or Call Identification Interface (CII), the KSU system Software Cartridge must be upgraded to DR5.

There are two possible situations where a software upgrade is necessary:

- 1 . upgrading from a DR2 Software Cartridge, or
2. upgrading from either a DR3 or a DR4 Software Cartridge.

Upgrading from DR2

If you are upgrading from a DR2 Software Cartridge, you must first upgrade to DR3 software.

When a DR3 Feature Cartridge is plugged into a DR2 KSU, an automatic upgrade takes place. In order to allow remote programming of the NVRAM and prevent the automatic upgrade, the following should be done:

1. Insert the **Software Cartridge** into the Data Cartridge prior to installing in the system.
2. Place the new DR3 Feature Cartridge assembly into a captive KSU with the appropriate Two-port or Six-port Expansion Cartridge, and power up the system.
3. Perform the Administration programming appropriate for the customer's site. This will maintain their DR2 programming.
4. Change the Time and Date (either the hour or minutes, or both). This sets a lock on the NVRAM data so that it cannot be updated.
5. Power down the captive KSU, remove the DR3 Feature Cartridge and take it to the customer site. To return a DR3 Feature Cartridge to the state where an automatic upgrade will occur, perform ** Startup on it while it is in the captive KSU.

Continue with the following procedure to install the DR3 Feature Cartridge assembly in the customer's KSU.

1. Make sure that the KSU power is OFF before installing or removing the DR3 Feature Cartridge assembly.
2. Make sure you are wearing a grounding strap when handling a cartridge.
- 3 . Insert the DR3 Feature Cartridge assembly into the KSU.

Once you have completed the upgrade to DR3 you can continue with the next procedure to upgrade from DR3 to DR5 software.

Upgrading from DR3 or DR4

1. Ensure that there is no call activity by informing all Norstar users that the system will briefly be out of operation.
2. Turn OFF the KSU power (unplug the power cord).
3. While wearing a grounding strap, remove the Feature Cartridge from the KSU.
4. Remove the Software Cartridge from the Data Cartridge.
5. Insert the new Software Cartridge into the Data Cartridge.
6. Insert the new Feature Cartridge into the KSU.
7. Turn ON the KSU power (plug in the power cord)-.

Wiring

Cable routing in the cable trough

Cable troughs beneath the KSU, Trunk Module, and Station Module hold the 25-pair cables, the DS-30 cables, the power cord(s), and the Power Bar (if required).

The cable troughs have been designed to keep the ac power cords and Power Bar separate from the connecting cables and to allow ease of access. Place the cabling in the two shelves, as described in the following chart and pages.

Upper shelf	All 25-pair cables and DS-30 cables: Place 25-pair cables in the back. Place the DS-30 cables in the front.
Lower shelf	All power cords and the Power Bar(s).

WARNING

To avoid electrical shock, hazard to personnel, or equipment damage, observe the following precautions when installing telephone equipment:

- ▮ Never install telephone wiring during a lightning storm.
- ▮ Never install telephone jacks in wet locations unless the jack is specifically designed for wet locations.
- ▮ Never touch non-insulated telephone wires or terminals unless the telephone line has been disconnected at the network interface.

Connecting internal wiring

To connect the internal telephones, each KSU and Station Module requires one 25-pair, 0.5-mm (24-AWG) cable with a female 50-pin connector at one end. Enough 50-pin distribution blocks are required to accommodate the internal wiring.

1. Plug the 50-pin connector of a 25-pair cable into the station connector on the KSU or the Station Module. (The connector is labeled with an icon representing a telephone.)



2. Route the cable(s) through the upper shelf of the cable troughs to the distribution block.

Note: Route the cables straight out to one side of the cable trough in a bundle. Use cable ties to secure them to the wall and to support their weight.

3. Connect the wires to the appropriate pins on the distribution block. (Refer to the wiring charts in this Guide.)
4. Cross-connect the KSU and Station Module telephone wires to the corresponding station pins on the distribution block. (Refer to the wiring charts in this Guide.)
5. Using a single pair of wires for each telephone, connect each of the telephones according to the wiring charts.

Connecting to the KSU

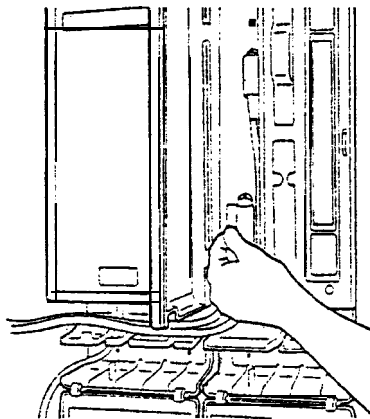

Connecting to the Station Module

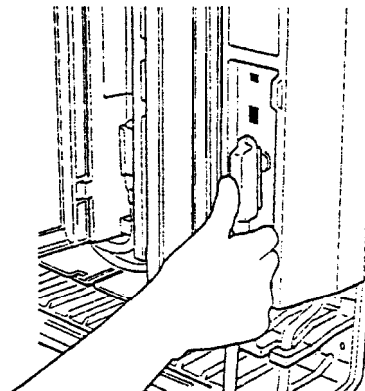

Connecting external lines

To connect the external lines and auxiliary equipment, each KSU and Trunk Module requires one 25-pair, 0.5mm (24-AWG) cable terminated with a female 50-pin connector on one end. A distribution block is required for each 25-pair cable.

1. Plug the 50-pin connector of a 25-pair cable into the external line connector on the KSU or the Trunk Module. (The connector is labeled with an icon representing telephone poles.)



2. Route the cable(s) through the upper shelf of the cable trough to the distribution block.

Note: Route the cables straight out to one side of the cable trough in a bundle. Use cable ties to secure them to the wall and to support their weight.

3. Cross-connect the external lines to the distribution block. (Refer to the KSU and Trunk Module external line wiring charts and wiring arrangement diagrams in this Guide.)
4. Connect the auxiliary equipment lines to the distribution block. (Refer to KSU and Trunk Module external line wiring charts and wiring arrangement diagrams in this Guide.)

Note: Auxiliary equipment cannot be connected to the RJ-21 interface.

5. Connect external lines to a standard RJ-21 interface:

Bring the external cable to the distribution block and use the distribution block to cross-connect to the corresponding KSU and Trunk Module external lines according to the KSU and Trunk Module external line wiring charts and diagrams. Refer to the following charts and illustrations in this Guide:

- Wiring arrangement for Norstar KSU
- Wiring arrangement for Norstar Trunk Module
- KSU external lines and auxiliary equipment wiring
- Loop Start/CI Trunk Cartridge wiring chart

6. Wire the auxiliary equipment lines separately. (Refer to the KSU and Trunk Module external line wiring charts and diagrams.)

Note: For the Trunk Module, the auxiliary equipment line is an Emergency Telephone (ET).

Connecting the KSU
external lines

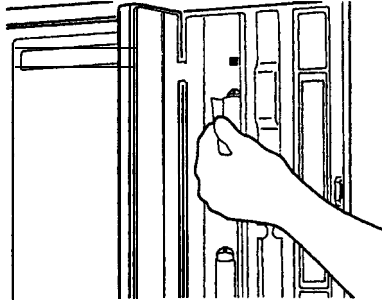

Connecting the Trunk
Module external lines

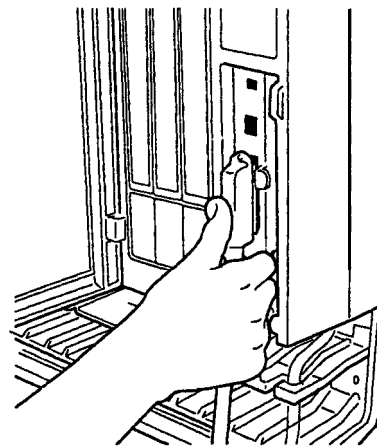

Norstar as an OPX

Norstar can be used as an off premise extension (OPX) from a PBX. In order to support this application, the OPX lines must be engineered not to exceed 7 dB total loop loss from the serving central office to the demarcation point at the Norstar KSU.

Connecting DS-30 cables

1. Plug one end of the DS-30 cable into the DS-30 port on the front of a Trunk Module or Station Module.
2. Route the cable through the cable clips on the right side of the Trunk Module or Station Module.
3. Route the cable through the upper shelf of the cable trough to the KSU and up through the cable clip to the Expansion Cartridge.

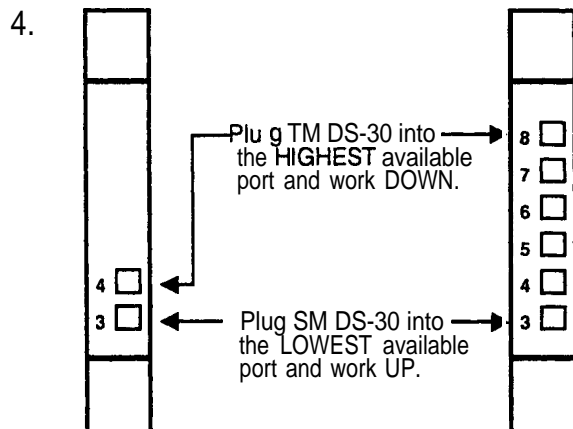

Plugging in a Trunk Module DS-30 cable

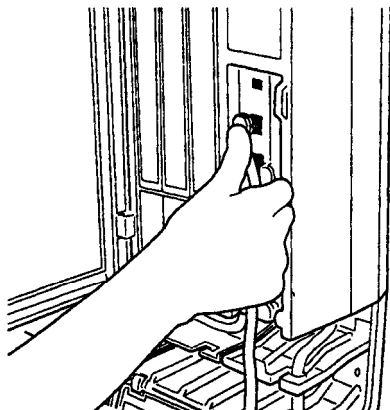

Plugging in a Station Module DS-30 cable

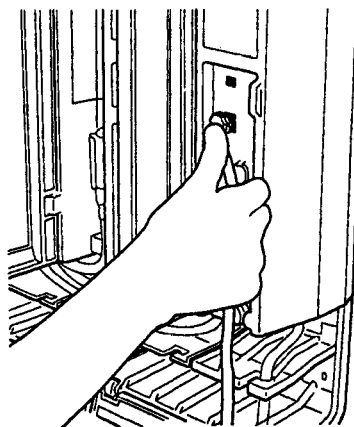

Emergency telephones

Emergency telephones (ET) are standard (500/2500) single-line telephones that provide emergency service in case of power failure or when power to the Norstar system is disconnected.

The KSU has two emergency telephone connections. Each Trunk Module has one emergency telephone connection.

Connecting emergency telephones

The procedure is the same for connecting emergency telephones to the distribution block for a KSU or a Trunk Module.

1. Wire a modular jack or equivalent to each set of emergency telephone pins on the 50-pin distribution block for KSU or Trunk Module external lines.

The connections on the distribution block for emergency telephones appear in the wiring charts in this Guide.

Note: The emergency telephone connections will not work if there is an E&M/DISA or DID Trunk Cartridge in the first slot of the Trunk Module.

2. Connect a single-line telephone to the modular jack.

Testing the emergency telephones

The emergency telephones must be tested with the power OFF at the KSU and Trunk Module.

1. Pick up the receiver of the emergency telephone.
2. Listen for the dial tone.

If you hear a dial tone, both the emergency telephone and the line are functioning properly.

If you hear no dial tone:

- Verify that power to the KSU and Trunk Module(s) is OFF.
 - Check that the external line and emergency telephone connections have been made correctly.
 - Ensure that the emergency telephone is not faulty, by connecting it directly to the external line and listening for dial tone.
 - Verify that there is dial tone on lines 1 and 2 of the KSU and on line 1 of the Trunk Module.
3. If all previous steps have been verified and there is still no dial tone at the emergency telephone, replace the KSU if the emergency telephone is connected to the KSU, or replace the Trunk Module if the emergency telephone is connected to the Trunk Module.

Norstar telephones

WARNING

Norstar telephones cannot be used as off-premise extensions (OPX). For OPX applications, use the Norstar Analog Terminal Adapter (ATA) and a single line telephone. (See the ATA installation card for details.)

Installing Norstar Telephones

1. Connect the receiver cord to the telephone modular jack indicated by the following symbol, then route the cord through the appropriate cord guide in the base of the telephone.



2. Connect the line cord to the telephone jack indicated by the following symbol, then route the cord through the appropriate cord guide.



3. Plug the other end of the line cord into the modular jack wired from the distribution block.
4. When the telephone is connected to the KSU or Station Module, the telephone display and indicators flash briefly while the telephone initializes (when the Norstar System is powered up). The telephone is fully operational when the display shows the default time and date.

For example: Jan 1 1: 00 am.

Note: If the telephone line is supported with auxiliary power, the power source must be a Class 2 device that is UL and CSA listed.

Wall-mounting a telephone

Norstar telephones can be mounted on the wall.

1. Remove the beveled wall-mounting base from the back of the telephone. Grip the telephone, and with your thumbs, push on the wide edge of the base to pop it out from the telephone.
2. Remove the receiver clip from the wall-mounting base. Install the clip in the forward lip of the receiver rest.
3. Use a screwdriver or similar tool to remove the center knock-out panel in the wall-mounting base.
4. Screw the base to the wall (thin end up) so that the wall jack projects through the knock-out.
5. Connect one end of the line cord to the telephone line jack (indicated by the symbol below).



6. Route the line cord through the appropriate cord guide in the bottom of the telephone.
7. Connect the other end of the line cord to the wall jack. Store any spare cord neatly in the base of the telephone and mount the telephone on the base.

Removing the
wall-mounting base

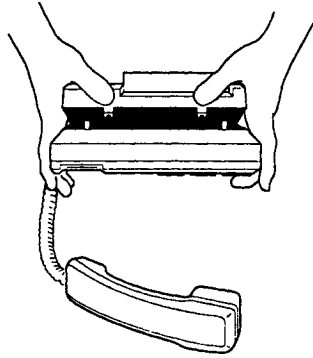

Installing the receiver clip



Removing the knock-out
panel

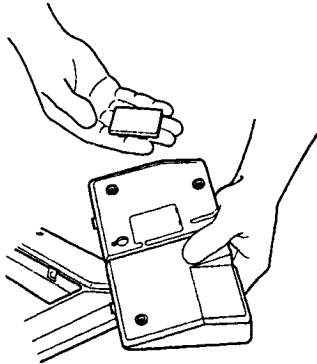

Installing the
wall-mounting base

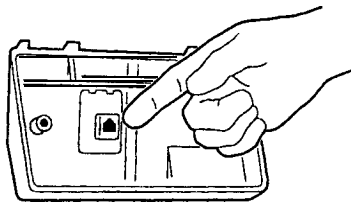

Connecting the line cord

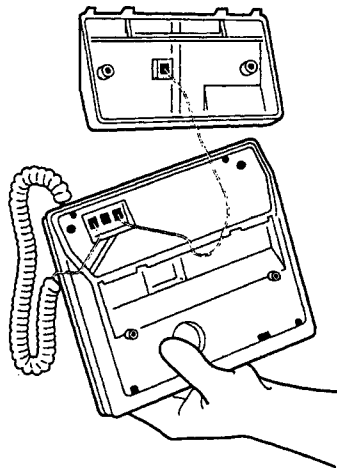

Mounting the telephone

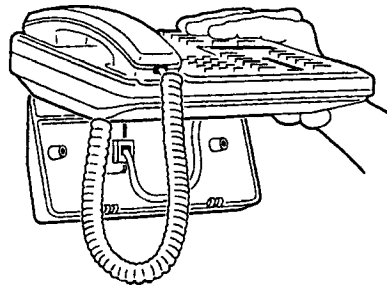

Applying the button cap labels

Before you apply button labels, activate the Button Inquiry feature (*) to verify the buttons' programmed functions, and to avoid activating features as you put the labels onto the buttons.

There are two types of button labels: printed and blank. Keep the extra labels and button caps with each Norstar telephone or leave them with the System Coordinator.

Types of button caps

- Unlabeled, clear button caps
with appropriate green or grey paper for typing in line numbers, telephone numbers, and features
- Pre-printed, colored button caps
in green or grey

Some example pre-printed button caps

Green caps	Grey caps
<input type="text" value="Line 1"/>	<input type="text" value="Last No."/>
<input type="text" value="Handsfree"/>	<input type="text" value="Speed Dial"/>

Note: To make identification of line types easier, use preprinted green button caps for lines that support incoming and outgoing calls. Use clear button caps for target lines that are incoming only.

Identifying the telephones

1. Write the individual telephone numbers on the labels and attach them to the appropriate **Norstar** telephones.
2. Write the telephone number and the internal number on the appropriate **Norstar** Receiver Card for each type and color of telephone that is to be installed.
3. Cover the **Norstar** Receiver Card underneath the receiver of each telephone with the plastic lens.

Norstar default button assignments

During Startup, the Installer chooses one of four default templates: Square, Centrex, Hybrid, or PBX. Default features are assigned automatically to the programmable buttons on Norstar telephones, and vary with the template and the telephone. The default features are listed in the tables in this chapter.

Note: Norstar telephones are shipped from the factory with the button caps in place for the Square template.

Rules of default button assignment

Line and Intercom buttons are assigned by default templates and can be changed in Configuration programming. Handsfree/Mute and Answer buttons are not assigned by default. If these features are defined, however, they are automatically assigned to specific buttons, as described on this and the following page. None of these buttons can be assigned to **M7100** Telephones.

Handsfree/Mute

This feature appears on the bottom right-hand button (the bottom button on the M7208 Telephone), moving the Intercom button(s) up one position.

Intercom

Each telephone can have up to eight Intercom buttons. They appear above the **Handsfree/Mute** button at the bottom right-hand position on your telephone (the bottom button on the M7208 Telephone).

Answer

Each telephone can have up to four Answer buttons. They appear above Intercom buttons in the right column and continue up from the bottom in the left column, replacing the features on those buttons. (On the M7208 Telephone, Answer buttons appear above Intercom buttons and below external line buttons in a single column.)

External line

External line buttons appear in ascending line order, starting at the top button in the left column (the top button on the M7208 Telephone). If more than five external lines are assigned to an M7310 Telephone, or more than 12 to an M7324 Telephone, assignment continues down the buttons on the right column, erasing the features on those buttons. Line buttons have priority over feature access buttons but not Handsfree/Mute, Intercom, or Answer buttons.

Telephone button defaults

Each column-Square, Centrex, Hybrid, and PBX-shows the defaults specific to these templates.

M7100 Telephone

For Square, Centrex, Hybrid, and PBX templates, the one programmable button on the M7100 Telephone is .

M7208 Telephone

The default button assignments for the M7208 Telephone depend on the template applied.

Square	Centrex	Hybrid	PBX
[Line]	Line<xx>	(Line)	[Pick-Up]
Line 2	Transfer	Line pool	Transfer
[Last]	Last No.	[No.]	[Last]
Page	Link	Page	Page
Conf/Trans	Conf/Trans	Conf/Trans	Conf/Trans
(Speed)	Speed Dial	Speed Dial	Speed Dial
(Intercom)	[Intercom]	[Ii-]	(Intercom)
[Intercom]	Intercom	Intercom	Intercom

Note: The default Page button activates the External Page option ().

M7310 Telephone

The default button assignments for the M7310 Telephone depend on the template applied. The exception is the default numbering for the dual-memory buttons.

Dual-memory buttons

Set 233	Set 237	Set 241
Set 221	Set 225	Set 229
Set 234	Set 238	Set 242
Set 222	Set 226	Set 230
Set 235	Set 239	Set 243
Set 223	Set 227	Set 231
Set 236	Set 240	Set 244
Set 224	Set 228	Set 232

This example shows defaults for a system with three-digit internal numbers.

These defaults do not actually exist on any telephone, as no telephone has an Autodial button for itself. The position that would be taken by the Autodial button for itself, is blank.

Template button assignments

Square		Centrex	
Line 1	Conf/Trans	Line<xx>	Conf/Trans
Line 2	Last No.	Transfer	Last No.
Call Fwd	Voice Call	Call Fwd	Voice Call
Pick-Up	Intercom	Pick-Up	Intercom
Page	Intercom	Link	Intercom

Hybrid		PBX	
Line 1	Conf/Trans	DND	Conf/Trans
Line pool	Last No.	Transfer	Last No.
Call Fwd	Voice Call	Call Fwd	Voice Call
Pick-Up	Intercom	Pick-Up	Intercom
Page	Intercom	Page	Intercom

M7324 Telephone

The default button assignments for the M7324 Telephone depend on the template applied.

Square		Centrex	
<input type="text" value="Line 1"/>	[C a l l]	<input type="text" value="Line<xx>"/>	[C a l l]
<input type="text" value="Line 2"/>	(S p e e d)	blank	[S p e e d]
blank	<input type="text" value="Last No."/>	blank	[N o .]
blank	<input type="text" value="Saved No."/>	blank	[L i n k]
blank	<input type="text" value="Conf/Trans"/>	blank	<input type="text" value="Conf/Trans"/>
blank	<input type="text" value="Transfer"/>	blank	<input type="text" value="Transfer"/>
blank	<input type="text" value="DND"/>	blank	<input type="text" value="DND"/>
blank	<input type="text" value="(Pick-Up)"/>	blank	<input type="text" value="(Pick-Up)"/>
blank	<input type="text" value="Voice Call"/>	blank	[C a l l]
blank	<input type="text" value="Page"/>	blank	<input type="text" value="Page"/>
blank	<input type="text" value="(Intercom)"/>	blank	<input type="text" value="Intercom"/>
blank	<input type="text" value="(Intercom)"/>	blank	<input type="text" value="(Intercom)"/>

Hybrid		PBX	
(L i n e)	<input type="text" value="Call Fwd"/>	blank	<input type="text" value="Call Fwd"/>
<input type="text" value="Line pool"/>	[S p e e d]	blank	<input type="text" value="Speed Dial"/>
blank	<input type="text" value="Last No."/>	blank	<input type="text" value="Last No."/>
blank	[S a v e d]	blank	<input type="text" value="Saved No."/>
blank	<input type="text" value="Conf/Trans"/>	blank	<input type="text" value="Conf/Trans"/>
blank	<input type="text" value="(Transfer)"/>	blank	<input type="text" value="(Transfer)"/>
blank	<input type="text" value="DND"/>	blank	<input type="text" value="DND"/>
blank	<input type="text" value="Pick-Up"/>	blank	<input type="text" value="Pick-Up"/>
blank	<input type="text" value="Voice Call"/>	blank	<input type="text" value="Voice Call"/>
blank	<input type="text" value="Page"/>	blank	<input type="text" value="Page"/>
blank	<input type="text" value="(Intercom)"/>	blank	<input type="text" value="(Intercom)"/>
blank	<input type="text" value="Intercom"/>	blank	<input type="text" value="(Intercom)"/>

Optional equipment

Auxiliary ringer (Customer Supplied)

The Norstar KSU provides a control contact to operate an external ringer. The auxiliary ringer can be activated by setting auxiliary ring for specific external lines, and auxiliary ring for specific telephones.

Refer to the chapters on programming for more details. Refer specifically to the following headings in Administration and Configuration.

Heading	Programmed in:
Trk/Line Data	Configuration
Capabilities	Administration
Service Modes	Administration

1. Follow the manufacturer's installation instructions.
2. Connect the Auxiliary Ring Generator to the 50-pin distribution block as shown in the wiring charts in this Guide.

The pins in this chart provide a control contact. They do not provide ring current or dc voltage. The ringer must not draw more than 50 mA from a 40-V dc source.

External music source (Customer Supplied)

Music for callers on Hold and for Background Music must be enabled through programming. Refer to the Programming chapter for more details. Refer specifically to the following programming headings in Configuration and confirm that the following settings are implemented:

Heading	Setting
Call Handling	On Hold: Music
Miscellaneous	Background Music: Yes

External music source programming

The music source can be any approved low-power device such as a radio with a high-impedance earphone jack. The recommended KSU input level is 1 V rms across an input impedance of 3300 Ω .

1. Connect the music source and ground to the 50-pin distribution block, as shown in the internal wiring charts in this Guide.

CAUTION

To avoid damage to audio equipment, ensure that the polarity of the audio input is correct according to the KSU internal wiring connector chart.

2. Adjust the volume of the music source to a comfortable level by activating Music on Hold or Background Music and adjusting the volume at the music source.

Note: Background Music volume can also be adjusted at each telephone.

Installing an external paging system

The paging system uses the speakers on Norstar telephones and can also be used with external loudspeakers provided by the customer. The paging output from the Norstar KSU is 775 mV rms across an input impedance of 600 Ω .

1. Follow the manufacturer's installation instructions.
2. Connect the paging system audio input to the 50-pin distribution block as shown in the internal wiring charts in this Guide.
3. Connect the pagingsystem relay to the 50-pin distribution block as shown in the internal wiring charts.

Note: Norstar system external paging does not support talk-back paging equipment unless an external line port is used.

In addition, the Norstar KSU provides a relay contact that can be used for other applications (for example, switching music ON or OFF).

External paging contacts

idle

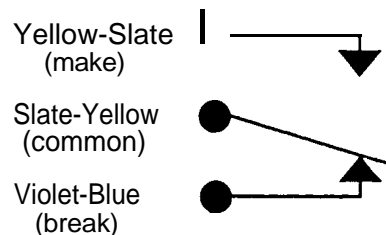

active

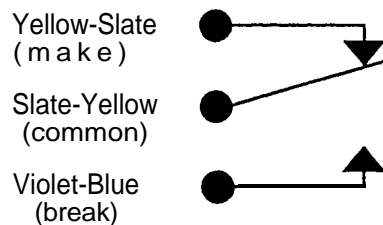

The Norstar KSU provides both a “make” (normally open) and a “break” (normally closed) set of contacts that operate in conjunction with the External Page feature. These contacts can be used to control various external devices. The external device being connected through these contacts must not draw more than 50 mA from a 40-V dc source.

Power Bar installation

CAUTION

For 110-V systems, use only a CSA certified and UL listed Power Bar having a third wire ground.

For 220-V systems, use only an approved Norstar 220-V Power Bar having a third wire ground.

1. Slide the Power Bar into the lower shelf of the cable trough. All power cords must go only in the lower shelf.

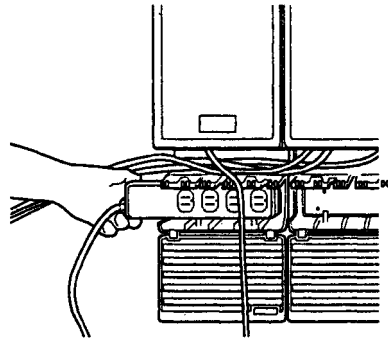

Where any combination of four or more Trunk or Station Modules is present, use a second Power Bar to provide additional plugs. On a 110-V system, the power cord from the second Power Bar must be plugged into the first Power Bar. On a 220-V system, the Power Bars are connected with a separate power cord.

2. Route the power cord from the KSU, Trunk Module, and Station Module through the cable clips located in the lower shelf of the cable trough.
3. Plug the KSU, Trunk Module, and Station Module power cords into the Power Bar(s).
4. If you have a 220-V system, plug the ac power cord into the Power Bar.

Power up the Norstar system

1. Double check all wiring before turning the system power ON.
2. Connect to the outlet (a non-switchable, third-wire ground ac outlet):

For a 110-V system:

If a Power Bar is used, plug the Power Bar into the ac outlet. Otherwise, plug the KSU power cord into the ac outlet.

For a 220-V system:

If a Power Bar is used, plug the Power Bar into the separate ac power cord. This ac power cord plugs into the ac outlet. Otherwise, plug the KSU power cord into the ac power cord. This ac power cord plugs into the ac outlet.

3. Check that the red power LEDs are ON. (The KSU, Trunk Module, and Station Module each have one LED.)

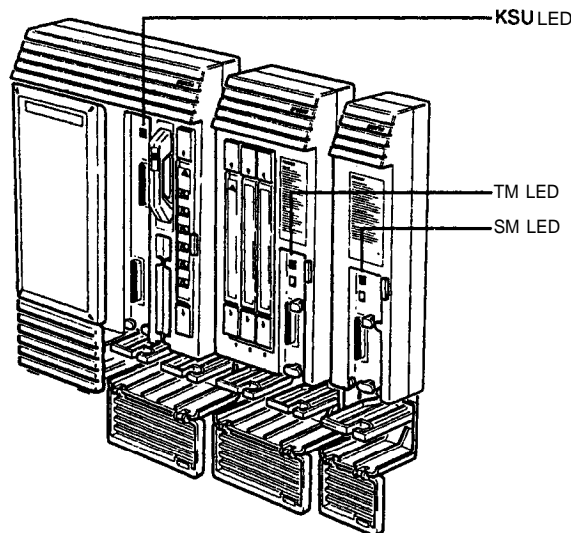

4. If none of the LEDs are ON, check the power at the ac outlet.
 - If there is no power, check with building maintenance.
 - OR
 - If there is ac power at the outlet, replace the module(s) that do not have a red LED ON.

Telephone relocation and replacement

Automatic Telephone Relocation and telephone replacement are features associated with moving and replacing Norstar telephones in the system. The basic difference is that relocation allows a moved telephone to retain its programming, and replacement re-assigns or removes programming.

Automatic Telephone Relocation

Automatic Telephone Relocation is disabled by default. For Automatic Telephone Relocation to work, the system power must be ON and the Automatic Telephone Relocation feature must be activated in Configuration programming.

A telephone can be moved to a new location within the **Norstar** system without losing its programmed settings. The internal numbers, **Autodial** settings, and **Personal Speed Dial** codes remain with the telephone when it is unplugged. To move a telephone, simply unplug it and plug it in again at another location. Recognition of the telephone by the KSU may take up to 45 seconds.

Notes: All **Norstar** telephones being moved should be relocated before new telephones are plugged into their place. This allows the moved telephones to retain their programmed settings. If a new telephone is plugged into the **Norstar** system before the old telephone is reconnected at a new location, **Norstar** will give the old telephone's information to the new telephone, and the old telephone will no longer be recognized by the system. (Refer to Telephone replacement, below.)

When changing a telephone's internal number (in Configuration programming), wait one minute after Automatic Telephone Relocation.

Telephone replacement

In a powered-up system, an existing Norstar telephone can be replaced by a new Norstar telephone. A new Norstar telephone is one that was not previously in service within the system.

Replacing **Norstar** telephones of the same type

If an existing Norstar telephone is unplugged, and a new Norstar #telephone of the same type is then plugged into the same jack (for example, replacing an M7208 Telephone with another M7208 Telephone), the new telephone acquires the programming and the internal number of the old telephone. This is normally done to replace a defective telephone.

Replacing **Norstar** telephones of different types

If an existing Norstar telephone is unplugged, and a new Norstar telephone of a different type is plugged into the same jack (for example, replacing an M7208 Telephone with an M7310 Telephone), the new telephone keeps the old internal number. The new telephone receives a default profile for a telephone of its type. (Refer to the button defaults listed in the section on **Norstar** telephones and system defaults listed in the Programming chapter).

Note: If the telephone being replaced has more lines than the new telephone, automatic outgoing line selection may not work with the Handsfree/Mute feature. A line must be selected manually.

Status of a telephone that was replaced

The old Norstar telephone that was unplugged, and replaced by a new **Norstar** telephone, loses its programming and internal number. The old telephone's internal number has been given to the new telephone and the programming has either been removed or given to the new telephone when it was plugged into the old jack. The replaced telephone (if still functional) is now treated by the system as a telephone not previously in service.

Regulations

Radio Frequency Interference

WARNING

This equipment generates, uses, and can radiate radio frequency energy. If not installed and used in accordance with the instruction manual, it may cause interference to radio communications. It has been tested and found to comply with the limits for a Class A computing device pursuant to Part 15 of the FCC Rules, which are designed to provide reasonable protection against such interference when operated in a commercial environment. Operation of this equipment in a residential area is likely to cause interference, in which case the user, at his own expense, will be required to take whatever measures may be required to correct the interference. Each Norstar Key Telephone System is assigned an FCC Registration Number and a Ringer Equivalence designation. The number and designation are printed on the Key Service Unit (KSU) label on the front of the unit inside the door.

Registration

The Norstar Key Telephone System is registered with the FCC based upon compliance with Part 68 of its rules. Connection of the Norstar Key Telephone System to the nationwide telecommunications network is made through a standard network interface jack that you can order from your telephone company. Jacks for this type of customer-provided equipment will not be provided on party lines or coin lines.

Interconnect

Norstar Modular equipment meets all applicable requirements of both the Canadian Department of Communications CS-03 and US Federal Commission FCC part 68 and has been registered under files DOC 3322492A and FCC AB67UJ-17156-KF-E (key system) and AB67UJ-17338-MF-E (hybrid system).

Ringer Equivalence Number (REN)

The FCC Registration Label, on the inside of the door on the front of the Key Service Unit (KSU), includes the Ringer Equivalence Number (REN). This number shows the electrical load that your Norstar KSU requires from your telephone line. If the KSU requires more electrical current than your telephone company's central office equipment can provide, your telephones may not ring and you may have difficulty dialing telephone numbers.

Call the telephone company to find out the total REN allowed for your telephone line(s).

Hearing Aid Compatibility

Norstar telephones are Hearing Aid compatible, as defined in Section 68.316 of Part 68 FCC Rules.

Electromagnetic compatibility (EMC)

Radiated emissions

Norstar Modular equipment meets all FCC part 15, class A radiated emissions requirements.

Conducted emissions

Norstar Modular equipment meets all FCC part 15, class A conducted emissions requirements.

Safety

Norstar Modular equipment meets all applicable requirements of both the Canadian Standards Association C22.2 No. 234 MI989 and US Underwriter's Laboratory UL-1459, and UL-1950, and has been registered under files CSA LR58855-12 and UL EI 15515 88NK16650.

Telephone Company Registration

It is usually not necessary to call the telephone company with information on the equipment before connecting the Norstar Key Telephone System Key Service Unit (KSU) to the telephone network but, if the telephone company requires this information, provide the following:

- Telephone number(s) to which the Key Service Unit (KSU) will be connected.
- FCC Registration Number (on label affixed to KSU, inside the door).
- Ringer Equivalence Number (on label affixed to KSU, inside the door).
- USOC Jack
RJ-21 X (RJ2HX for E&M/DISA service)
- Service Order Code (SOC) 9.0 F
- Facility Interface Code
(FIC)02LS2 (TL32M for E&M/DISA service)

Use of a Music source

In accordance with U.S. Copyright Law, a license may be required from the American Society of Composers, Authors and Publishers, or similar organization if Radio or TV broadcasts are transmitted through the Music On Hold or Background Music features of this telecommunication system.

Northern Telecom Inc. hereby disclaims any liability arising out of the failure to obtain such a license.

This digital apparatus does not exceed the Class A limits for radio noise emissions from digital apparatus set out in the Radio Interference Regulations of the Canadian Department of Communications.

Rights of the Telephone Company

If the system is determined to be causing harm to the telephone network, the telephone company may discontinue your service temporarily. If possible, the telephone company will notify you in advance. If advance notice is not practical, you will be notified as soon as possible. You will be given the opportunity to correct the situation and you will be informed of your right to file a complaint to the FCC. Your telephone company may make changes in its facilities, equipment, operations or procedures that could affect the proper functioning of your system. If it does this, you will be notified in advance to give you the opportunity to maintain uninterrupted telephone service.

In the event of an equipment malfunction, all repairs will be performed by Northern Telecom Inc. or by one of its authorized dealers.

Address of a repair facility

USA

Northern Telecom Inc.
Product Service Center
640 Massman Drive
Nashville, TN
37210
Attn.. RA# _____

Canada

Northern Telecom Canada Ltd.
Customer Service Dept. 914
12345 Boul Albert Hudon
Montreal-Nord, Québec
H1G 3L1

Specifications and wiring charts

Service tone cadences

Tone	Cadence (seconds)
Busy	0.5 ON / 0.5 OFF
Overflow	0.25 ON / 0.25 OFF
Ringback	2.0 ON / 4.0 OFF
Confirmation tone	1 .0 ON / 1 .0 OFF (3 bursts followed by no tone)
Recall tone	1 .0 ON / 1 .0 OFF (3 bursts followed by steady tone)
Ring splash	0.2 ON (1 burst)

Power specifications for the 110 V system

Characteristic	KSU	TM	SM
Voltage V ac	92-127	92-127	92-127
Current A rms (max)	1.75	1.75	1.0
Frequency Hz	47-63	47-63	47-63
Crest factor	4.0	4.0	4.0

Power specifications for the 220 V system

Characteristic	KSU	TM	SM
Voltage V ac	170-264	170-264	170-264
Current A rms (max)	1.0	1.0	0.5
Frequency Hz	45-63	45-63	45-63
Crest factor	4.0	4.0	4.0

Telephone loop specifications

Characteristic	Value
Loop resistance	50 Ω (295 m of 0.5 mm wire or 1000 ft of 24 AWG wire)
Loop length	150 Ω per conductor between TC and network interface for E, SG, M, and SB leads on an E&M/DISA TC
Terminating impedance	600 Ω
Flash rate (incoming alerting call)	1 Hz (50% duty cycle)
Minimum voltage at telephone	10 V dc
Current at telephone (idle)	45 mA nominal
Current at telephone (active)	80 mA maximum

Electrical requirements

Characteristic	Spec/Value
Electrostatic discharge KSU and telephones	IEC 801-2 severity level 4 maximum of 12 kV with a 150 Ω /150 pF probe
Connectors	IEC 801-2 severity level 2
Radiated immunity	maximum of 5 V/m from 10 kHz to 1 GHz
Conducted immunity	maximum of 2 V rms or 86 dB μ A from 0.06 to 0.1 MHz maximum of 92 dB μ A from 0.011 to 30 MHz

Mechanical requirements

Vibration operational	IEC 68-2-6-Fc
Resonance search	IEC 68-2-6-Fc
Vibration endurance transportation	IEC 68-2-6-Fc
Bounce	IEC 68-2-55 A
Shock fragility	IEC 68-2-27-Ea
Unpacked drop	IEC 68-2-31 -Ec
Packaged drop	NSTA Proj. 1A

Environmental requirements

Characteristic	Spec/Value
Operating temperature range	I.E.C. 68-2-1 Tests Ad and Ab 0°C to 50°C(32°F to 122°F)
Storage temperature range	I.E.C. 68-2-2 Test Bd -55°C to 70°C (-67°F to 158°F)
Thermal shock	I.E.C. 68-2-14 Test Na
Humidity above 34°C (93°F)	5% to 95% (non-condensing) 52 mbar of water vapor pressure

Humidity

Norstar Modular equipment can operate from 0°C to 50°C (32°F to 122°F) with relative humidities between 5% and 95% RH except that at temperatures above 34°C (93°F) the relative humidity may be limited to 52 mbar of water vapor pressure.

For the purpose of demonstration of compliance, the product shall be exposed to 40°C (104°F) at 90% to 95% RH for 3 days followed by operational tests.

In addition, the product (without its transportation package) shall be able to withstand 10 days storage at 40°C (104°F) at 90% to 95% RH as per I.E.C. 68-2-3, Test Ca, Severity A, without evidence of corrosion, physical damage or degradation in electrical performance.

Transportation methods

No special constraints need be applied to standard methods of shipment (such as air freight, truck, and rail) except for the -55°C (-67°F) storage limit..

Port numbering

Port number coding on the wiring charts

The code shown for “Ports” (as on the wiring charts for Trunk Module external line wiring and Station Module internal wiring) shows the link between particular port numbers and the wiring on the distribution block. This is useful for example, in tracking down faults during a Maintenance session where codes appear on a Norstar telephone display indicating error messages (see the Maintenance chapter).

The code shown on the charts (for example: “X12”) has two components:

- “X” corresponds to the number which appears on the face of the Expansion Cartridge port to which the Trunk Module or Station Module is connected.
- Numerical digits (for example “01” or “12”) identify an individual port number associated with that Expansion Cartridge.

For example:

The code “812” appearing as part of an error message for a Trunk Module indicates Expansion Cartridge port #8 and internal port “12”. The corresponding Trunk Module pins on the distribution block are Pin 47 (Violet-Orange) and Pin 22 (Orange-Violet). These codes apply to both Trunk Modules and Station Modules (up to “X1 6” for Station Modules for up to 16 telephones; up to “X12” for Trunk Modules for up to 12 external lines).

Norstar system numbering plan

The Norstar system provides flexibility in the assignment of line pool access codes and internal numbers (also called Directory Numbers or DNS).

The Numbering Plan follows specific rules such as:

- Internal numbers can have up to seven digits.
- All internal numbers must have the same number of digits.
- Line pool access codes are one to four digits, and cannot start with the same number as:
 - the first digit of any internal number
 - the first digit of any Received number
 - the Park prefix
 - the Direct-dial digit
- The digit “0” may be assigned to a telephone. If this is the case, no internal number or Call Park Retrieval code can begin with “0”.
- The same sequence of digits cannot be used for two internal numbers, for two line pool access codes, or for both an internal number and a line pool access code. All codes and numbers must be unique.
- Symbols such as an asterisk (*) or a pound sign (#) cannot be used in internal numbers or line pool access codes.

Key Service Unit (KSU)

The Key Service Unit (KSU) has 8 lines and 24 telephones.

In the charts on the following page, notice that the KSU has two internal ports, KSU #1 and KSU #2. KSU #1 handles telephones. KSU #2 handles lines.

Two-port Expansion Cartridge

One or two DS-30 cables for Trunk Modules and/or Station Modules can be plugged into a Two-port Expansion Cartridge.

Six-port Expansion Cartridge

A combination of up to six Trunk Modules and/or Station Modules can be plugged into a Six-port Expansion Cartridge.

B1 and B2 Directory Numbers (DN)

The terms B1 and B2 correspond to channels on Norstar for transmitting voice and data. Each DN port number has a B1 DN and a B2 DN. Devices such as the Norstar M7100, M7208, M7310, and M7324 Telephones use only the B1 DN. Other devices may need both B1 and B2 channels, therefore requiring B1 and B2 DNs.

Non-expanded system (KSU alone) numbering

Port #	External lines	External line ports	B1 DN	B2 DN	DN ports
KSU (#2)	1-8	201-208	- -	- -	- -
KSU (#1)	- -	- -	21-44	45-68	101-124

Two-port Expansion Cartridge and KSU numbering

Expansion port #	External lines	External line ports	B1 DN	B2 DN	DN ports
#4	9-20	401-412	261-276	317-332	401-416
#3	21-32	301-312	245-260	301-316	301-316
KSU (#2)	1-8	201-208	- -	- -	- -
KSU (#1)	- -	- -	221-244	277-300	101-124

Six-port Expansion Cartridge and KSU numbering

Expansion port #	External lines	External line ports	B1 DN	B2 DN	DN ports
#8	9-20	801-812	325-340	445-460	801-816
#7	21-32	701-712	309-324	429-444	701-716
#6	33-44	601-612	293-308	413-428	601-616
#5	45-56	501-512	277-292	397-412	501-516
#4	57-68	401-412	261-276	381-396	401-416
#3	69-80	301-312	245-260	365-380	301-316
KSU (#2)	1-8	201-208	---	---	---
KSU (#1)	---	---	221-244	341-364	101-124

Note: B1 and B2 telephone numbers reflect the default numbering scheme.

Note: Port #3 is the bottom DS-30 cable port on both the Two-port and the Six-port Expansion Cartridge.

KSU wiring charts

Wiring arrangement for Not-star KSU

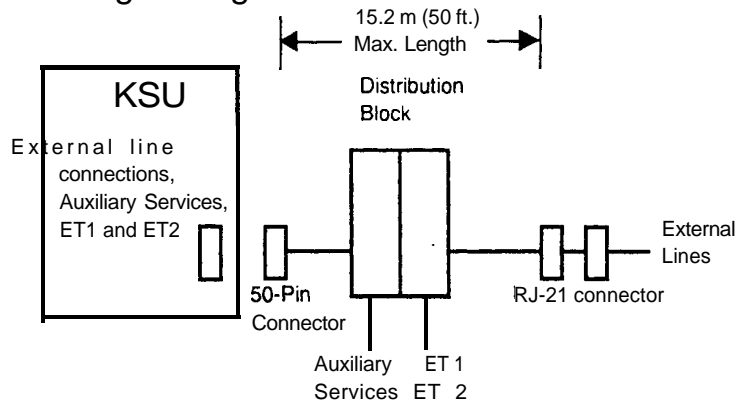

See the wiring chart for the Key Service Unit (KSU) to external lines and auxiliary equipment connecting arrangement.

Wiring arrangement for **Norstar** TM

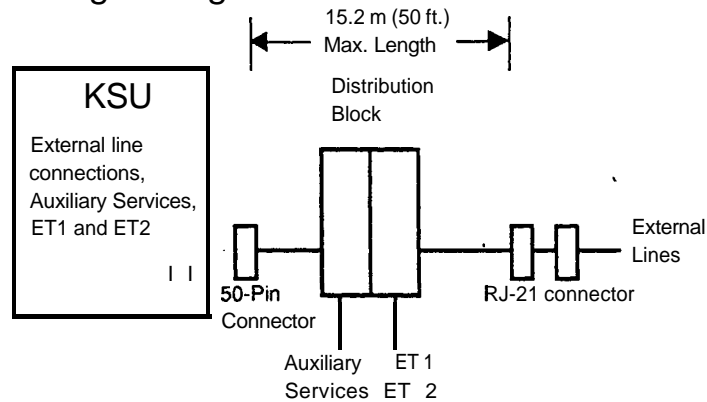

See the wiring chart for the Trunk Module (TM) to external lines connecting arrangement.

KSU external lines and auxiliary equipment wiring

KSU external lines connector					RJ-21 external line connector	
Pin	Wire color	Port	Service	Line	Pin	Wire color
26	White-Blue	201	T	1	26	White-Blue
1	Blue-White	201	R	1	1	Blue-White
27	White-Orange	202	T	2	27	White-Orange
2	Orange-White	202	R	2	2	Orange-White
28	White-Green	203	T	3	28	White-Green
3	Green-White	203	R	3	3	Green-White
29	White-Brown	204	T	4	29	White-Brown
4	Brown-White	204	R	4	4	Brown-White
30	White-Slate	205	T	5	30	White-Slate
5	Slate-White	205	R	5	5	Slate-White
31	Red-Blue	206	T	6	31	Red-Blue
6	Blue-Red	206	R	6	6	Blue-Red
32	Red-Orange	207	T	7	32	Red-Orange
7	Orange-Red	207	R	7	7	Orange-Red
33	Red-Green	208	T	8	33	Red-Green
8	Green-Red	208	R	8	8	Green-Red

Port number code: see the explanation page preceding the charts.

KSU external lines connector				Aux equipment connections	
Pin	Wire color	Service	Line	Pin	Wire color
34	Red-Brown		No connection		
9	Brown-Red		No connection		
35	Red-Slate	T	ET 1	35	Red-Slate
10	Slate-Red	R	ET 1	10	Slate-Red
36	Black-Blue	T	ET2	36	Black-Blue
11	Blue-Black	R	ET2	11	Blue-Black
37	Black-Orange	----	No connection	----	----
12	Orange-Black	----	No connection	----	----
38	Black-Green	----	No connection	----	----
13	Green-Black	----	No connection	----	----
39	Black-Brown	----	No connection	----	----
14	Brown-Black	----	No connection	----	----
40	Black-Slate	----	No connection	----	----
15	Slate-Black	----	No connection	----	----
41	Yellow-Blue	----	No connection	----	----
16	Blue-Yellow	----	No connection	----	----
42	Yellow-Orange	----	No connection	----	----
17	Orange-Yellow	----	No connection	----	----
43	Yellow-Green	T	Auxiliary Ring Make	43	Yellow-Green
18	Green-Yellow	R	Auxiliary Ring Common	18	Green-Yellow
44	Yellow-Brown	T	Auxiliary Ring Break	44	Yellow-Brown
19	Brown-Yellow		No connection	19	Brown-Yellow
45	Yellow-Slate	T	Page Relay Make	45	Yellow-Slate
20	Slate-Yellow	R	Page Relay Common	20	Slate-Yellow
46	Violet-Blue	T	Page Relay Break	46	Violet-Blue
21	Blue-Violet		No connection	21	Blue-Violet
47	Violet-Orange	T	Page Out Tip	47	Violet-Orange
22	Orange-Violet	R	Page Out Ring	22	Orange-Violet
48	Violet-Green	----	No connection	----	----
23	Green-Violet	----	No connection	----	----
49	Violet-Brown	---	No connection	----	----
24	Brown-Violet	----	No connection	----	----
50	Violet-Slate	----	No connection	----	----
25	Slate-Violet	----	No connection	----	----

Note: Auxiliary equipment can not be connected to the RJ-21 connector.

84 / KSU wiring charts

KSU internal wiring

Pin	Wire color	Port	Service	Telephones (KSU)	Default DN
26	White-Blue	101	T	1	
1	Blue-White	101	R	1	21/221/2221
27	White-Orange	102	T	2	
2	Orange-White	102	R	2	22122212222
28	White-Green	103	T	3	
3	Green-White	103	R	3	23122312223
29	White-Brown	104	T	4	
4	Brown-White	104	R	4	24122412224
30	White-Slate	105	T	5	
5	Slate-White	105	R	5	25/225/2225
31	Red-Blue	106	T	6	
6	Blue-Red	106	R	6	26/226/2226
32	Red-Orange	107	T	7	
7	Orange-Red	107	R	7	27122712227
33	Red-Green	106	T	6	
6	Green-Red	108	R	8	28122812228
34	Red-Brown	109	T	9	
9	Brown-Red	109	R	9	29122912229
35	Red-Slate	110	T	10	
10	Slate-Red	110	R	10	30/230/2230
36	Black-Blue	111	T	11	
11	Blue-Black	111	R	11	31123112231
37	Black-Orange	112	T	12	
12	Orange-Black	112	R	12	32123212232
38	Black-Green	113	T	13	
13	Green-Black	113	R	13	33/233/2233
39	Black-Brown	114	T	14	
14	Brown-Black	114	R	14	34/234/2234
40	Black-Slate	115	T	15	
15	Slate-Black	115	R	15	35123512235
41	Yellow-Blue	116	T	16	
16	Blue-Yellow	116	R	16	36123612236
42	Yellow-Orange	117	T	17	
17	Orange-Yellow	117	R	17	37/237/2237
43	Yellow-Green	116	T	16	
18	Green-Yellow	118	R	18	38/238/2238
44	Yellow-Brown	119	T	19	
19	Brown-Yellow	119	R	19	39/239/2239
45	Yellow-Slate	120	T	20	
20	Slate-Yellow	120	R	20	40/240/2240
46	Violet-Blue	121	T	21	
21	Blue-Violet	121	R	21	41/241/2241
47	Violet-Orange	122	T	22	
22	Orange-Violet	122	R	22	42/242/2242
48	Violet-Green	123	T	23	
23	Green-Violet	123	R	23	43/243/2243
49	Violet-Brown	124	T	24	
24	Brown-Violet	124	R	24	44/244/2244
50	Violet-Slate	----	----	Music-on-hold ground	----
25	Slate-Violet	----	----	Music-on-hold input	----

Note: T and R represent station connections and should not be confused with Tip and Ring on external lines. Station connections are non-polarized.

CAUTION: For 'Music -on-hold', ensure that the polarity of the audio input is the same as identified above for pins 50(Violet-Slate) and 25(Slate-Violet) to avoid damage to audio equipment

Station Module wiring chart

Pin	Wire color	Port	Service	Telephones (SM)
26	White-Blue	x01	T	1
1	Blue-White	x01	R	1
27	White-Orange	X02	T	2
2	Orange-White	X02	R	2
28	White-Green	X03	T	3
3	Green-White	X03	R	3
29	White-Brown	X04	T	4
4	Brown-White	X04	R	4
30	White-Slate	X05	T	5
5	Slate-White	X05	R	5
31	Red-Blue	X06	T	6
6	Blue-Red	X06	R	6
32	Red-Orange	X07	T	7
7	Orange-Red	X07	R	7
33	Red-Green	X08	T	8
8	Green-Red	X08	R	8
34	Red-Brown	x09	T	9
9	Brown-Red	x09	R	9
35	Red-Slate	x10	T	10
10	Slate-Red	x10	R	10
36	Black-Blue	X11	T	11
11	Blue-Black	x11	R	11
37	Black-Orange	x12	T	12
12	Orange-Black	x12	R	12
38	Black-Green	x13	T	13
13	Green-Black	x13	R	13
39	Black-Brown	X14	T	14
14	Brown-Black	x14	R	14
40	Black-Slate	x15	T	15
15	Slate-Black	x15	R	15
41	Yellow-Blue	X16	T	16
16	Blue-Yellow	X16	R	16
42	Yellow-Orange	----	----	no connection
17	Orange-Yellow	----	----	no connection
43	Yellow-Green	----	----	no connection
18	Green-Yellow	----	----	no connection
44	Yellow-Brown	----	----	no connection
19	Brown-Yellow	----	----	no connection
45	Yellow-Slate	----	----	no connection
20	Slate-Yellow	----	----	no connection
46	Violet-Blue	----	----	no connection
21	Blue-Violet	----	----	no connection
47	Violet-Orange	----	----	no connection
22	Orange-Violet	----	----	no connection
48	Violet-Green	----	----	no connection
23	Green-Violet	----	----	no connection
49	Violet-Brown	----	----	no connection
24	Brown-Violet	----	----	no connection
50	Violet-Slate	----	----	no connection
25	Slate-Violet	----	----	no connection

Note: T and R represent station connections and should not be confused with Tip and Ring on external lines. Station connections are non-polarized.

Note: Port number code: see the explanation page preceding the charts.

Loop Start or CI Trunk Cartridge wiring chart

TM 50-pin connector arrangement						RJ-21 connector	
TC Slot	Pin	Wire color	Port	Service	Line	Pin	Wire color
Slot 1	1	White-Blue	X01	T	1	26	White-Blue
	1	Blue-White	X01	R	1	1	Blue-White
	2	White-Orange	X02	T	2	27	White-Orange
	2	Orange-White	X02	R	2	2	Orange-White
	3	White-Green	----	No connection	----	----	----
	3	Green-White	----	No connection	----	----	----
	4	White-Brown	----	No connection	----	----	----
	4	Brown-White	----	No connection	----	----	----
	5	White-Slate	X03	T	3	28	White-Green
	5	Slate-White	X03	R	3	3	Green-White
	6	Red-Blue	X04	T	4	29	White-Brown
	6	Blue-Red	X04	R	4	4	Brown-White
	7	Red-Orange	----	No connection	----	----	----
	7	Orange-Red	----	No connection	----	----	----
	8	Red-Green	----	No connection	----	----	----
	8	Green-Red	----	No connection	----	----	----
Slot 2	9	Red-Brown	X05	T	5	30	White-Slate
	9	Brown-Red	X05	R	5	5	Slate-White
	10	Red-Slate	X06	T	6	31	Red-Blue
	10	Slate-Red	X06	R	6	6	Blue-Red
	11	Black-Blue	----	No connection	----	----	----
	11	Blue-Black	----	No connection	----	----	----
	12	Black-Orange	----	No connection	----	----	----
	12	Orange-Black	----	No connection	----	----	----
	13	Black-Green	X07	T	7	32	Red-Orange
	13	Green-Black	X07	R	7	7	Orange-Red
	14	Black-Brown	X08	T	8	33	Red-Green
	14	Brown-Black	X08	R	8	8	Green-Red
	15	Black-Slate	----	No connection	----	----	----
	15	Slate-Black	----	No connection	----	----	----
	16	Yellow-Blue	----	No connection	----	----	----
	16	Blue-Yellow	----	No connection	----	----	----
Slot 3	17	Yellow-Orange	x09	T	9	34	Red-Brown
	17	Orange-Yellow	x09	R	9	9	Brown-Red
	18	Yellow-Green	X10	T	10	35	Red-Slate
	18	Green-Yellow	X10	R	10	10	Slate-Red
	19	Yellow-Brown	----	No connection	----	----	----
	19	Brown-Yellow	----	No connection	----	----	----
	20	Yellow-Slate	----	No connection	----	----	----
	20	Slate-Yellow	----	No connection	----	----	----
	21	Violet-Blue	X11	T	11	36	Black-Blue
	21	Blue-Violet	X11	R	11	11	Blue-Black
	22	Violet-Orange	x12	T	12	37	Black-Orange
	22	Orange-Violet	x12	R	12	12	Orange-Black
	23	Violet-Green	----	No connection	----	----	----
	23	Green-Violet	----	No connection	----	----	----
	24	Violet-Brown	----	No connection	----	----	----
	24	Brown-Violet	----	No connection	----	----	----
25	Violet-Slate	----	ET	----	----	No connection	
25	Slate-Violet	----	ET	----	----	No connection	

Note: Auxiliary equipment can not be connected to the RJ-21 connector.
For an explanation of Port codes, see the section called Port number coding on the wiring charts.

E&M or DISA Trunk Cartridge wiring chart

Using the **E&M/DISA** wiring chart

Use the diagrams in this section when a Norstar Trunk Module (TM) contains E&M/DISA Trunk Cartridges (TC) or a mixture of E&M/DISA and DID or loop start TCs.

Chart: Trunk Module with **E&M/DISA** cartridges

— shows the 50-pin connections on the TM.

— shows the RJ2HX/CA2HA cross-connections;

— to be used where E&M/DISA TCs alone are installed.

To obtain the cross-connections for E&M/DISA service, read across, the column headings.

Example of how to read wiring charts for mixed service

— to be used where there is a mixture of E&M/DISA, DID, and loop start TCs.

To obtain the cross-connections for mixed service, match Service columns on the appropriate charts in the example.

Note: When installing a mixture of E&M/DISA and DID or loop start TCs, it is important to cross-connect the wiring for each type of TC to a separate distribution block.

In addition, the cross-connections to each distribution block must always begin at pins 26 and 1. This allows you to wire to the correct pins for an RJ-21 connection and for an RJ2HX/CA2HA connection.

Note: To retain emergency telephone function, a loop start TC

E&M/DISA cross connections

When you are required to connect two RJ2HX/CA2HA distribution blocks together (connecting to another Norstar or Private Branch Exchange), you will need to make these cross connections:

Back-to-back cross connections

1 st distribution block	T	R	T1	R1	E	SG	M	SB
Next distribution block	T1	R1	T	R	SB	M	SG	E

E&M or DISA Trunk Cartridge wiring chart / 89

Trunk Module with **E&M/DISA** Trunk Cartridges and **RJ2HX/CA2HA** wiring connections

TM 50-pin connector arrangement						RJ2HX/CA2HA connector	
TC Slot	Pin	Wire color	Port	Service	Line	Pin	Wire color
Slot 1	26	White-Blue	X01	T	1	26	White-Blue
	1	Blue-White	x01	R	1	1	Blue-White
	27	White-Orange	x01	T1	1	27	White-Orange
	2	Orange-White	x01	R1	1	2	Orange-White
	28	White-Green	x01	E	1	28	White-Green
	3	Green-White	x01	SG	1	3	Green-White
	29	White-Brown	X01	M	1	29	White-Brown
	4	Brown-White	x01	SB	1	4	Brown-White
	30	White-Slate	X02	T	2	30	White-Slate
	5	Slate-White	X02	R	2	5	Slate-White
	31	Red-Blue	X02	T1	2	31	Red-Blue
	6	Blue-Red	X02	R1	2	6	Blue-Red
	32	Red-Orange	X02	E	2	32	Red-Orange
	7	Orange-Red	X02	M	2	7	Orange-Red
	33	Red-Green	X02	SB	2	33	Red-Green
	8	Green-Red	X02		2	8	Green-Red
Slot 2	34	Red-Brown	X03	T	3	34	Red-Brown
	9	Brown-Red	X03	R	3	9	Brown-Red
	35	Red-Slate	X03	T1	3	35	Red-Slate
	10	Slate-Red	X03	R1	3	10	Slate-Red
	36	Black-Blue	X03	E	3	36	Black-Blue
	11	Blue-Black	X03	SG	3	11	Blue-Black
	37	Black-Orange	X03	M	3	37	Black-Orange
	12	Orange-Black	X03	SB	3	12	Orange-Black
	38	Black-Green	X04	T	4	38	Black-Green
	13	Green-Black	X04	R	4	13	Green-Black
	39	Black-Brown	X04	T1	4	39	Black-Brown
	14	Brown-Black	X04	R1	4	14	Brown-Black
	40	Black-Slate	X04	E	4	40	Black-Slate
	15	Slate-Black	X04	M	4	15	Slate-Black
	41	Yellow-Blue	X04	SB	4	41	Yellow-Blue
	16	Blue-Yellow	X04		4	16	Blue-Yellow
Slot 3	42	Yellow-Orange	X05	T	5	42	Yellow-Orange
	17	Orange-Yellow	X05	R	5	17	Orange-Yellow
	43	Yellow-Green	X05	T1	5	43	Yellow-Green
	18	Green-Yellow	X05	R1	5	18	Green-Yellow
	44	Yellow-Brown	X05	E	5	44	Yellow-Brown
	19	Brown-Yellow	X05	SG	5	19	Brown-Yellow
	45	Yellow-Slate	X05	M	5	45	Yellow-Slate
	20	Slate-Yellow	X05	SB	5	20	Slate-Yellow
	46	Violet-Blue	X06	T	6	46	Violet-Blue
	21	Blue-Violet	X06	R	6	21	Blue-Violet
	47	Violet-Orange	X06	T1	6	47	Violet-Orange
	22	Orange-Violet	X06	R1	6	22	Orange-Violet
	48	Violet-Green	X06	E	6	48	Violet-Green
	23	Green-Violet	X06	SG	6	23	Green-Violet
	49	Violet-Brown	X06	M	6	49	Violet-Brown
	24	Brown-Violet	X06	SB	6	24	Brown-Violet
50	Violet-Slate	----	ET	----	----	No connection	
25	Slate-Violet	----	ET	----	----	No connection	

Note: Auxiliary equipment can not be connected to the RJ2HX/CA2HA connector.
For an explanation of Port codes, see the section called Port number coding on the charts.

Example of how to read the **E&M/DISA** wiring chart

M12x0 Trunk module with Loop Start and E&M/DISA cartridges

Trunk module (TM) 50-pin connector arrangement

TC Slot	Pin	Wire Color	Port	Service
Slot 1				
	26	White-Blue	X01	T
	1	Blue-White	X01	R
	27	White-Orange	X02	T
	2	Orange-White	X02	R
	28	White-Green	--	no connection
	3	Green-White	--	no connection
	29	White-Brown	--	no connection
	4	Brown-White	--	no connection
	30	White-Slate	X03	T
	5	Slate-White	X03	R
	31	Red-Blue	X04	T
	6	Blue-Red	X04	R
	32	Red-Orange	--	no connection
	7	Orange-Red	--	no connection
	33	Red-Green	--	no connection
	8	Green-Red	--	no connection
Slot 2				
	34	Red-Brown	X05	T
	9	Brown-Red	X05	R
	35	Red-Slate	X06	T
	10	Slate-Red	X06	R
	36	Black-Blue	--	no connection
	11	Blue-Black	--	no connection
	37	Black-Orange	--	no connection
	12	Orange-Black	--	no connection
	38	Black-Green	X07	T
	13	Green-Black	X07	R
	39	Black-Brown	X08	T
	14	Brown-Black	X08	R
	40	Black-Slate	--	no connection
	15	Slate-Black	--	no connection
	41	Yellow-Blue	--	no connection
	16	Blue-Yellow	--	no connection
Slot 3				
	42	Yellow-Orange	X09	T
	17	Orange-Yellow	X09	R
	43	Yellow-Green	X09	T1
	18	Green-Yellow	X09	R1
	44	Yellow-Brown	X09	E
	19	Brown-Yellow	X09	SG
	45	Yellow-Slate	X09	M
	20	Slate-Yellow	X09	SB
	46	Violet-Blue	X10	T
	21	Blue-Violet	X10	R
	47	Violet-Orange	X10	T1
	22	Orange-Violet	X10	R1
	48	Violet-Green	X10	E
	23	Green-Violet	X10	SG
	49	Violet-Brown	X10	M
	24	Brown-Violet	X10	SB
	50	Violet-Slate	--	ET
	25	Slate-Violet	--	ET

RJ-21/CA-21 wiring connections (Loop Start)

Service	Line	Pin	Wire Color
T	1	26	White-Blue
R	1	1	Blue-White
T	2	27	White-Orange
R	2	2	Orange-White
T	3	28	White-Green
R	3	3	Green-White
T	4	29	White-Brown
R	4	4	Brown-White
T	5	30	White-Slate
R	5	5	Slate-White
T	6	31	Red-Blue
R	6	6	Blue-Red
T	7	32	Red-Orange
R	7	7	Orange-Red
T	8	33	Red-Green
R	8	8	Green-Red
T	9	34	Red-Brown
R	9	9	Brown-Red
T	10	35	Red-Slate
R	10	10	Slate-Red
T	11	36	Black-Blue
R	11	11	Blue-Black
T	12	37	Black-Orange
R	12	12	Orange-Black

RJ2HX/CA2HA wiring connections (E&M/DISA)

Service	Line	Pin	Wire Color
T	1	26	White-Blue
R	1	1	Blue-White
T1	1	27	White-Orange
R1	1	2	Orange-White
E	1	28	White-Green
SG	1	3	Green-White
M	1	29	White-Brown
SB	1	4	Brown-White
T	2	30	White-Slate
R	2	5	Slate-White
T1	2	31	Red-Blue
R1	2	6	Blue-Red
E	2	32	Red-Orange
SG	2	7	Orange-Red
M	2	33	Red-Green
SB	2	8	Green-Red
T	3	34	Red-Brown
R	3	9	Brown-Red
T1	3	35	Red-Slate
R1	3	10	Slate-Red
E	3	36	Black-Blue
SG	3	11	Blue-Black
M	3	37	Black-Orange
SB	3	12	Orange-Black
T	4	38	Black-Green
R	4	13	Green-Black
T1	4	39	Black-Brown
R1	4	14	Brown-Black
E	4	40	Black-Slate
SG	4	15	Slate-Black
M	4	41	Yellow-Blue
SB	4	16	Blue-Yellow
T	5	42	Yellow-Orange
R	5	17	Orange-Yellow
T1	5	43	Yellow-Green
R1	5	18	Green-Yellow
E	5	44	Yellow-Brown
SG	5	19	Brown-Yellow
M	5	45	Yellow-Slate
SB	5	20	Slate-Yellow
T	6	46	Violet-Blue
R	6	21	Blue-Violet
T1	6	47	Violet-Orange
R1	6	22	Orange-Violet
E	6	48	Violet-Green
SG	6	23	Green-Violet
M	6	49	Violet-Brown
SB	6	24	Brown-Violet
--	no connection	50	--
--	no connection	25	--

Wiring charts for mixed service

Shown here is an installation with two Loop Start TCs in Slots 1 and 2 and one EBMIDISA TC in Slot 3.

Slots 1 and 2: Only the T and R leads are connected.

Slot 3: All leads are connected.

Note that the E&M/DISA connections (on the RJ2HX/CA2HA chart) begin on a new distribution block. Line numbers begin at pins 26 and 1 to indicate the first E&M/DISA (RJ2HX/CA2HA) line.

DID Trunk Cartridge wiring chart

Using the DID wiring chart

Use the diagrams in this section when a Norstar Trunk Module (TM) contains DID Trunk Cartridges (TC) or a mixture of DID and E&M/DISA or loop start TCs.

Chart: Trunk Module with DID cartridges

— shows the 50-pin connections on the TM.

— shows the RJ-21 cross-connections;

— to be used where DID TCs alone are installed.

To obtain the cross-connections for DID service, read across the column headings.

Example of how to read wiring charts for mixed service,

— to be used where there is a mixture of DID and E&M/DISA or loop start TCs.

To obtain the cross-connections for mixed service, match Service columns on the appropriate charts in the example.

Note: When installing a mixture of DID and E&M/DISA or loop start TCs, it is important to cross-connect the wiring for each type of TC to a separate distribution block.

In addition, the cross-connections to each distribution block must always begin at pins 26 and 1. This allows you to wire to the correct pins for an RJ-21 connection and for an RJ2HX/CA2HA connection.

Note: To retain Emergency Telephone function with mixed service, a loop start TC should go in the first slot of the TM.

DID supervisory signaling

Allowing this equipment to be operated in a manner that does not provide for proper answer supervision signaling, as outlined below, is in violation of FCC Part 68 Rules, and may be in violation of local tariffs.

This equipment is designed to return supervisory signals to the Public Switched Telephone Network (PSTN) when the DID calls are:

- answered, by the called station
- answered by the attendant
- routed to a customer controlled recorded announcement
- routed to a dial prompt

This equipment is designed to return supervisory signals on all DID calls forwarded through the system back to the PSTN within 20 s of the call forwarding sequence being initiated.

Emergency transfer conditions

Every DID Trunk Cartridge has a Control Circuit Interface (CCI) which should be connected directly to the Central Office for monitoring purposes.

If the **Norstar** system loses power or the microcontroller on the DID Trunk Cartridge malfunctions, the CCI signals the Central Office that it can no longer handle DID calls. The Central Office, by pre-arrangement, can then forward the DID lines to other numbers.

Note: The CCI signaling to report power loss or malfunction of the DID Trunk Cartridge is not supported by all carriers. For carriers or installations which do not use CCI signaling, the CCI and ET connections should be treated as “No connection”.

Trunk Module with DID Trunk Cartridges and RJ-21 wiring connections

TM 50-pin connector arrangement						RJ-21 connector	
TC Slot	Pin	Wire color	Port	Service	Line	Pin	Wire color
Slot 1	26	White-Blue	X01	T	1	26	White-Blue
	1	Blue-White	x01	R	1	1	Blue-White
	27	White-Orange	X02	T	2	27	White-Orange
	2	Orange-White	X02	R	2	2	Orange-White
	28	White-Green	---	No connection	---	---	---
	3	Green-White	---	No connection	---	---	---
	29	White-Brown	---	CCI NC1	---	28	White-Green
	4	Brown-White	---	CCI Com1	---	3	Green-White
	30	White-Slate	X03	T	3	29	White-Brown
	5	Slate-White	X03	R	3	4	Brown-White
	31	Red-Blue	X04	T	4	30	White-Slate
	6	Blue-Red	X04	R	4	5	Slate-White
	32	Red-Orange	---	No connection	---	---	---
	7	Orange-Red	---	No connection	---	---	---
	33	Red-Green	---	No connection	---	---	---
	8	Green-Red	---	No connection	---	---	---
Slot 2	34	Red-Brown	X05	T	5	31	Red-Blue
	9	Brown-Red	X05	R	5	6	Blue-Red
	35	Red-Slate	X06	T	6	32	Red-Orange
	10	Slate-Red	X06	R	6	7	Orange-Red
	36	Black-Blue	---	No connection	---	---	---
	11	Blue-Black	---	No connection	---	---	---
	37	Black-Orange	---	CCI NC1	---	33	Red-Green
	12	Orange-Black	---	CCI Com1	---	8	Green-Red
	38	Black-Green	X07	T	7	34	Red-Brown
	13	Green-Black	X07	R	7	9	Brown-Red
	39	Black-Brown	X08	T	8	35	Red-Slate
	14	Brown-Black	X08	R	8	10	Slate-Red
	40	Black-Slate	---	No connection	---	---	---
	15	Slate-Black	---	No connection	---	---	---
	41	Yellow-Blue	---	No connection	---	---	---
	16	Blue-Yellow	---	No connection	---	---	---
Slot 3	42	Yellow-Orange	x09	T	9	36	Black-Blue
	17	Orange-Yellow	x09	R	9	11	Blue-Black
	43	Yellow-Green	x10	T	10	37	Black-Orange
	18	Green-Yellow	x10	R	10	12	Orange-Black
	44	Yellow-Brown	---	No connection	---	---	---
	19	Brown-Yellow	---	No connection	---	---	---
	45	Yellow-Slate	---	CCI NC1	---	38	Black-Green
	20	Slate-Yellow	---	CCI Com1	---	13	Green-Black
	46	Violet-Blue	x11	T	11	39	Black-Brown
	21	Blue-Violet	x11	R	11	14	Brown-Black
	47	Violet-Orange	x12	T	12	40	Black-Slate
	22	Orange-Violet	x12	R	12	15	Slate-Black
	48	Violet-Green	---	No connection	---	---	---
	23	Green-Violet	---	No connection	---	---	---
	49	Violet-Brown	---	No connection	---	---	---
	24	Brown-Violet	---	No connection	---	---	---
50	Violet-Slate	---	ET	---	---	No connection	
25	Slate-Violet	---	ET	---	---	No connection	

Note: Auxiliary equipment can not be connected to the RJ-21 connector.

Port codes are explained in the section Port number coding on the wiring charts.

Note: For CCI connections in Service column: NC1 stands for the normally closed relay and Com1 the common relay.

Note: CCI signaling is not supported by all carriers. For carriers or installations which do not use CCI signaling, the CCI and ET connections should be treated as "No connection".

CCI wiring is a non-standard wiring arrangement which has been submitted to the DOC.

Example of how to read the DID wiring chart

M12x0 Trunk module with DID and E&M/DISA cartridges

Trunk module (TM) 50-pin connector arrangement

TC Slot	Pin	Wire Color	Pin#	Service
Slot 1	26	White-Blue	X01	T
	1	Blue-White	X01	R
	27	White-Orange	X02	T
	2	Orange-White	X02	R
	28	White-Green	--	no connection
	3	Green-White	--	CCI NC1
	29	Brown-White	--	CCI Com1
	4	Brown-White	--	CCI Com1
	30	White-Slate	X03	T
	5	Slate-White	X03	R
	31	Red-Blue	X04	T
	6	Blue-Red	X04	R
	32	Red-Orange	--	no connection
	7	Orange-Red	--	no connection
	33	Red-Green	--	no connection
	8	Green-Red	--	no connection
Slot 2	34	Red-Brown	X05	T
	9	Brown-Red	X05	R
	35	Red-Slate	X06	T
	10	Slate-Red	X06	R
	36	Black-Blue	X06	R
	11	Blue-Black	--	no connection
	37	Black-Orange	--	CCI NC1
	12	Orange-Black	--	CCI Com1
	38	Black-Green	X07	T
	13	Green-Black	X07	R
	39	Black-Brown	X08	T
	14	Brown-Black	X08	R
	40	Black-Slate	--	no connection
	15	Slate-Black	--	no connection
	41	Yellow-Blue	--	no connection
	16	Blue-Yellow	--	no connection
Slot 3	42	Yellow-Orange	X09	T
	17	Orange-Yellow	X09	R
	43	Yellow-Green	X09	T
	18	Green-Yellow	X09	R1
	44	Yellow-Brown	X09	E
	19	Brown-Yellow	X09	SG
	45	Yellow-Slate	X09	M
	20	Slate-Yellow	X09	SB
	46	Violet-Blue	X10	T
	21	Blue-Violet	X10	R
	47	Violet-Orange	X10	T1
	22	Orange-Violet	X10	R1
	48	Violet-Green	X10	E
	23	Green-Violet	X10	SG
	49	Violet-Brown	X10	M
	24	Brown-Violet	X10	SB
50	Violet-Slate	--	ET	
25	Slate-Violet	--	ET	

RJ-21/CA-21 wiring connections (DID)

Service	Line	Pin	Wire Color
T	1	26	White-Blue
R	1	1	Blue-White
T	2	27	White-Orange
R	2	2	Orange-White
CCI	-	28	White-Green
CCI	-	3	Green-White
T	3	29	White-Brown
R	3	4	Brown-White
T	4	30	White-Slate
R	4	5	Slate-White
T	5	31	Red-Blue
R	5	6	Blue-Red
T	6	32	Red-Orange
R	6	7	Orange-Red
CCI	-	33	Red-Green
CCI	-	8	Green-Red
T	7	34	Red-Brown
R	7	9	Brown-Red
T	8	35	Red-Slate
R	8	10	Slate-Red
T	9	36	Black-Blue
R	9	11	Blue-Black
T	10	37	Black-Orange
R	10	12	Orange-Black
CCI	-	38	Black-Green
CCI	-	13	Green-Black
T	11	39	Black-Brown
R	11	14	Brown-Black
T	12	40	Black-Slate
R	12	15	Slate-Black

RJ2HX/CA2HA wiring connections (E&M/DISA)

Service	Line	Pin	Wire Color
T	1	26	White-Blue
R	1	1	Blue-White
T1	1	27	White-Orange
R1	1	2	Orange-White
E	1	28	White-Green
SG	1	3	Green-White
M	1	29	White-Brown
SB	1	4	Brown-White
T	2	30	White-Slate
R	2	5	Slate-White
T1	2	31	Red-Blue
R1	2	6	Blue-Red
E	2	32	Red-Orange
SG	2	7	Orange-Red
M	2	33	Red-Green
SB	2	8	Green-Red
T	3	34	Red-Brown
R	3	9	Brown-Red
T1	3	35	Red-Slate
R1	3	10	Slate-Red
E	3	36	Black-Blue
SG	3	11	Blue-Black
M	3	37	Black-Orange
SB	3	12	Orange-Black
T	4	38	Black-Green
R	4	13	Green-Black
T1	4	39	Black-Brown
R1	4	14	Brown-Black
E	4	40	Black-Slate
SG	4	15	Slate-Black
M	4	41	Yellow-Blue
SB	4	16	Blue-Yellow
T	5	42	Yellow-Orange
R	5	17	Orange-Yellow
T1	5	43	Yellow-Green
R1	5	18	Green-Yellow
E	5	44	Yellow-Brown
SG	5	19	Brown-Yellow
M	5	45	Yellow-Slate
SB	5	20	Slate-Yellow
T	6	46	Violet-Blue
R	6	21	Blue-Violet
T1	6	47	Violet-Orange
R1	6	22	Orange-Violet
E	6	48	Violet-Green
SG	6	23	Green-Violet
M	6	49	Violet-Brown
SB	6	24	Brown-Violet
--	no connection	50	--
--	no connection	25	--

Wiring charts for mixed service

Shown here is an installation with one DID TCE in Slot 1 and 2 and one E&M/DISA TCE in Slot 3.

Slots 1 and 2: Only the T, R, and CCI leads are connected.

Slot 3: All leads are connected.

Note that the E&M/DISA connections (on the RJ2HX/CA2HA chart) begin on a new distribution block. Line numbers begin at pins 26 and 1 to indicate the first E&M/DISA (RJ2HX/CA2HA) line.

Programming

After the hardware has been installed and powered up, use Startup to initialize the system, and select one of the four system templates.

CAUTION

Startup erases any existing programmed data, and resets the system to factory defaults.

Performing Startup

1. Enter the Startup access code from a Norstar M7324 or M7310 telephone dial pad, by pressing

Feature * * 7 8 2 7 8 8 7

which is the same as

Feature * * S T A R T U P .

To be accepted, the Startup code must be entered no later than 15 minutes after the Norstar system has been powered up. (If 15 minutes have elapsed since you powered up the system, turn system power OFF and ON, to prepare for the Startup process.)

2. Enter the Installer password:

2 6 6 3 4 4

which is the same as

C O N F I G .

The Installer password is not shown on the display.

Note: The Installer password shown is the default normally used for Startup. For a system which has already been programmed, the Installer password might have been changed in Configuration and recorded below.

--	--	--	--	--	--	--

CAUTION

Wait at least two minutes after Startup before you . attempt Maintenance diagnostic tests or the disabling/enabling of a module. If you do not wait two minutes, ports may be disabled.

Changing the default template

. After entering the Startup access code and Installer password the display shows **Reset memory?**.

1. To select a default template, press **YES**.
The display shows **Template: Square**.
OR
To exit without choosing a template, press **CANCEL**.
2. Press **CHANGE** to choose one of four templates (Square, Centrex, Hybrid or PBX).
3. Press **Next** to store the programming.
The display shows **Template applied**.
The indicators begin to flash after a few moments.
The display shows Jan 1 1: **00** am.

If power fails

All Configuration and Administration programming is retained for three days if the power fails or if the Norstar system is powered OFF. After three days without power, it may be necessary to perform Startup.

Startup defaults

The four templates available in the Norstar system are Square, Centrex, Hybrid, and PBX. The following charts show the default settings for each template.

Square defaults are listed in full. Centrex, Hybrid and PBX defaults are listed only when they differ from Square defaults.

Where a DN is specified, it is the three-digit DN that is the default on an expanded system. (Two-digit DNs are the default on non-expanded systems.)

Configuration defaults

Trk/Line Data

Trunk data

Parameter	Square	Centrex	Hybrid	PBX
Line <xxx> (Trunk type)	Loop			
Trunk mode	Unsupervised			
Ans mode	Manual			
Ans with DISA (presented if Ans mode is Auto)	Y e s			
Signal (presented if Line is E&M)	WinkStart			
Gain (presented if Line is E&M)	Normal			
Dial mode	Pulse			
Full AutoHold on idle line (presented if Line is Loop)	No			

98 / Startup defaults

Received number (target lines only)

Parameter	Square	Centrex	Hybrid	PBX
Rec'd #	None			

Line data (physical and target lines)

Parameter	Square	Centrex	Hybrid	PBX
Line type	Public	Public	Lines	Pool t
			001 to 008:	Pool A
			009 to 012:	Pool B
			013 to 016:	Pool C
			017 to 020:	Pool D
			021 to 024:	Pool E
			025 to 028:	Pool F
			029 to 032:	Pool G
			033 to 036:	Pool H
			037 to 040:	Pool I
			041 to 044:	Pool J
			045 to 048:	Pool K
			049 to 052:	Pool L
053 to 056:	Pool M			
057 to 060:	Pool N			
061 to 064:	Pool O			
Prime Telephone for each line	DN 221			
Auxiliary ringer for each line	Yes			
Auto privacy	Yes			

† Target lines cannot be placed into line pools.

Line Access

Parameter	Square	Centrex	Hybrid	PBX
Line assignment	Line 001 Line 002	Line <nnn> †	Line 001	No lines assigned
Answer DNs	None			
Ringing lines	Ring for all DNs. Any lines added Ring.	Ring for all assigned lines. Any lines added Ring.	Ring for DN 221. No ring for other DNs. Any lines added Ring.	No lines assigned. Any lines added Ring.
Ringing lines for target lines	No target lines are assigned automatically, but any lines added will be Ring			
Line Pool access	No	No	Yes (Pool A)	
Intercom keys	2			
Prime line	None	Line <nnn> †	Intercom	Intercom

† <nnn> is a three digit line number. The Centrex template automatically performs a sequential assignment of lines to DNs. It assigns Line 001 to DN 221, Line 002 to DN 222, and so on, until all lines in the system have been assigned to DNs. These lines are automatically made the Prime Lines for the DNs.

Call Handling

Parameter	Square	Centrex	Hybrid	PBX
Held line reminder	No			
Remind delay (s) (presented if Held line reminder is changed to Yes)	60			
DRT to Prime Telephone	Yes			
DRT delay (rings)	3			
Transfer callback (rings)	3			
Park prefix	1			
Park timeout (s)	45			
Camp timeout (s)	45			
Directed pickup	Yes			
On hold	Tones			

(s) is seconds.

Miscellaneous

Parameter	Square	Centrex	Hybrid	PBX
Background music	No			
Direct-dial #	0			
DISA DN	None			
Auto DN	None			
Alarm Telephone	DN 221			
CAP assignment	None			
Link time (ms)	600			
Telephone relocation	No			
Host Delay (ms)	1000			
Supervision (ms)	460			
External code	9	9	None	None
Line pool codes	None	None	9 for Pool A None for Pools B to 0	9 for Pool A None for Pools B to 0
Installer password	C O N F I G OR 2 6 6 3 4 4			

(ms) is milliseconds.

System data

Parameter	Square	Centrex	Hybrid	PBX
Individual DNs	Individual DNs may be changed.			
DN length	2 (non-expanded system) 3 (expanded system)			
Rec'd # length	3 (Received numbers are used only on expanded systems.)			

General administration defaults

System Speed Dial

Parameter	Square	Centrex	Hybrid	PBX
Speed dial #	(no defaults assigned)			
Line or Pool	Use Prime line			
Display digits	Yes			
Name (presented if Display digits is changed to No)	Sys Spd Dial <#nn>			
Bypass restriction	No			

<#nn> is a two-digit System Speed Dial code (#12, for example).

Names

Parameter	Square	Centrex	Hybrid	PBX
Set names	DN (221, for example)			
Line names	Line number (Line 001, for example)			

Time and date

The default time and date is: 1:00 a.m., January 1st, 1992

Direct-Dial

Parameter	Square	Centrex	Hybrid	PBX
Set1	DN 221			
Set2, Set3, Set4, Set5	None			

Capabilities

Dialing filters

Parameter	Square	Centrex	Hybrid	PBX
Filter 00	No restrictions (cannot be changed)			
Filter 01				Hybrid and PBX settings are the same as those for the Square template
Restriction 01	0	90		
Restriction 02	1	91		
Exceptions	1800 1555 1 ↑*555 1*0*555	91800 91555 91*1*555 91*0*555		
Restriction 03	911	9911		
Exceptions	911	9911		
Restriction 04	411	9411		
Restriction 05	976	9976		
Filter 02 to 99	No restrictions			

Remote access packages

Parameter	Square	Centrex	Hybrid	PBX
Package 00	Prohibits access to line pools and Remote Page. Cannot be changed.			
Package 01				
Line pool access	Y for Pool A N for Pools B to 0			
Remote Page	No			
Packages 02 - 15				
Line pool access	N for Pools A to 0			
Remote Page	No			

Set abilities (Capabilities cont'd)

Parameter	Square	Centrex	Hybrid	PBX
Set filter	02			
Line/set filter	None			
Telephone lock	None			
Full handsfree	No			
Automatic handsfree (presented if Full handsfree is Yes)	No			
Handsfree Answerback	Yes			
Pickup group	No			
Paging	Y			
Page zone	1			
Auxiliary Ringer	No			
Direct-Dial	Set1			
Forward on busy	None			
Forward no answer	None			
Forward delay (# of rings - presented if Forward no answer is ON)	3			
Allow redirect	No			
Redirect ring	Yes			
Hotline	None			
Use Prime line (presented for external Hotline)	Yes			
Priority call	No			

Line abilities (Capabilities cont'd)

Parameter	Square	Centrex	Hybrid	PBX
Line filter	03			
Remote filter	04			
Remote pkg	00			

Class of Service (COS) passwords (Capabilities cont'd)

Parameter	Square	Centrex	Hybrid	PBX
COS passwords	None			
User filter	Deflt †			
Line filter	Deflt †			
Remote pkg	Deflt †			

† The 'Deflt' setting means that no COS filter is programmed by default. Any filters programmed elsewhere to apply to the telephone, the line or the user's COS password are still in effect.

Service Modes

Parameter	Square	Centrex	Hybrid	PBX
Control Telephones	DN 221			
Name1	Night (if Setting is changed from Manual to Auto: Start = 23:00, Stop = 07:00)			
Name2	Evening (if Setting is changed from Manual to Auto: Start = 17:00, Stop = 23:00)			
Name3	Lunch (if Setting is changed from Manual to Auto: Start = 12:00, Stop = 13:00)			
Setting	Manual			
Trunk answer	Yes			
Extra-dial Telephone	221			
Ringing Telephone	221			
Auxiliary Ringer	Yes			

Password

Parameter	Default
Administration password	<input type="checkbox"/> A <input type="checkbox"/> D <input type="checkbox"/> M <input type="checkbox"/> I <input type="checkbox"/> N OR q o a a a

Log Defaults

Parameter	Default
Space/Log	0

Call Services

Parameter	Default
Auto Call info	None
Autolog/Show Vmsg Logging set Show Extl Vmsg	N N
Log space Log Pool	0 600
Log password	None
1 st display	Name
Vmsg center tel# Center 1 to 5	. None
Vmsg center lines	1

Configuration overview

Configuration programming is performed by the Installer or the Customer Service representative, and lets you change settings for the entire Norstar system, as well as settings for individual telephones and external lines. Configuration programming is the first programming done after system installation.

This chapter contains information for programming Configuration settings. If you are new to programming, you may want to practice using the detailed Administration programming procedures in the System Coordinator Guide before attempting other procedures.

For information on Administration programming, and Personal programming, see the System Coordinator Guide.

How programming is done

Programming is done at an M7324 or M7310 Telephone. Use the buttons on the telephone to program a setting or to request a specific programming action.

Norstar guides you step by step on the telephone display while you access programming, select and change programmable settings, and exit programming.

Reviewing programmed settings

The Set Profile and Line Profile features help you to check your programming by allowing you to review the settings. For more information, see the System Coordinator Guide.

Vogramming overview

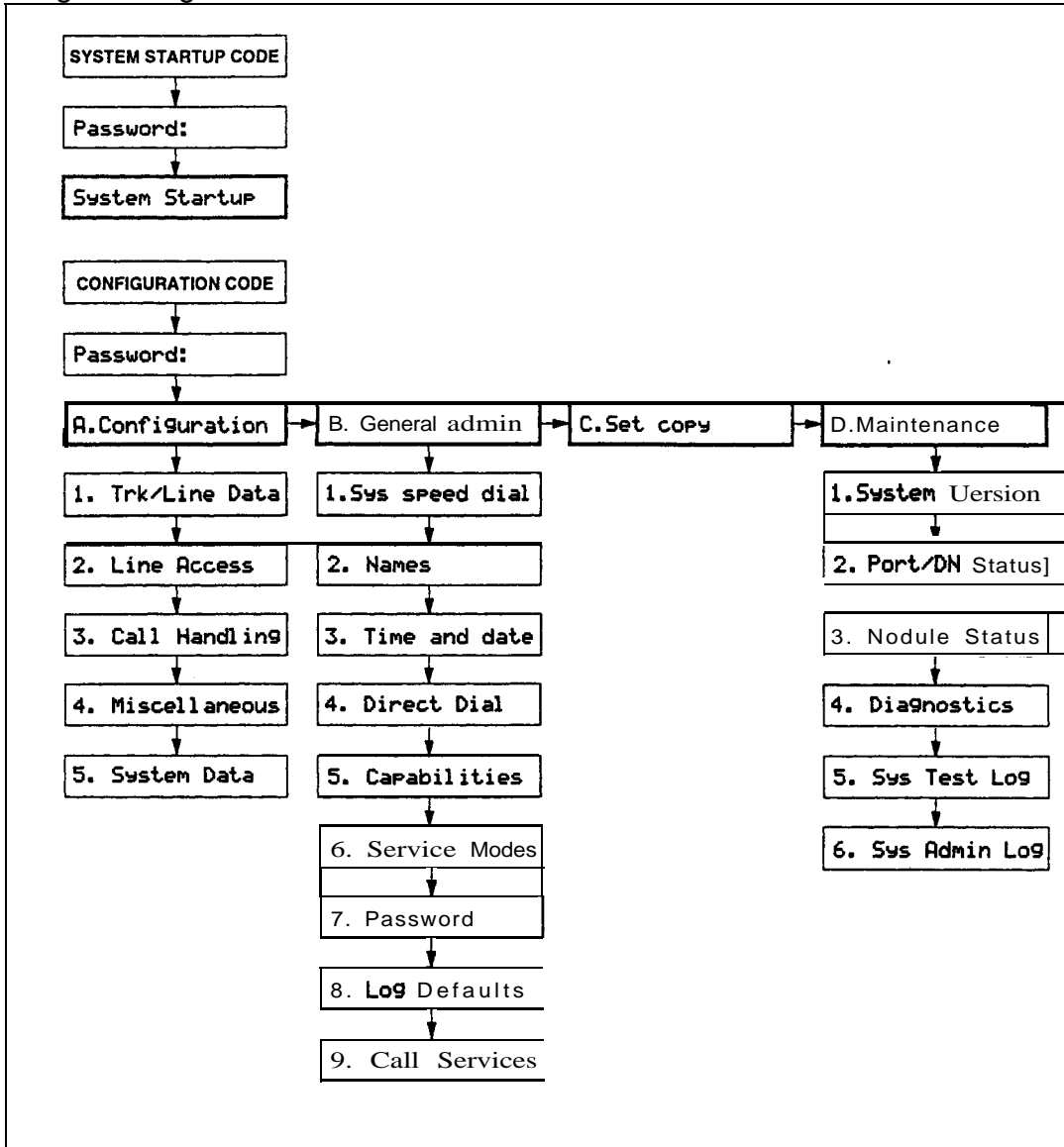

Programming tools

A **Norstar** telephone

System programming can only be performed on an M7310 or M7324 Telephone.

The **Norstar Programming Overlay**

The *Norstar Programming Overlay* is a paper cutout that labels four telephone buttons used during programming. This makes it easier for you to identify the button that you want. The *Norstar Programming Overlay* is provided at the end of this book.

Norstar Programming Overlay

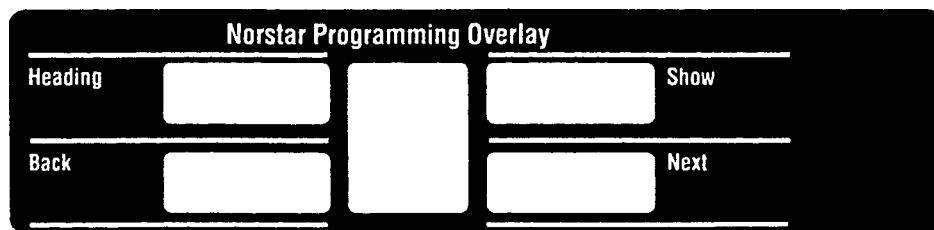

The **Norstar** Modular DR5 Programming Record

The *Norstar Modular DR5 Programming Record* provides a convenient way to record what you have programmed. It also helps you to plan your programming. Settings are grouped according to their function.

Pages from the Record may be photocopied as necessary for programming many telephones or lines.

The **Norstar** Telephone User Cards

Each Norstar telephone has a *Norstar Telephone User Card* that lists the most commonly used features.

The **Norstar** Modular **DR5** Telephone Feature Card

The *Norstar Modular DR5 Telephone Feature Card* lists the features that can be accessed with the button.

Entering Configuration

1. Release all calls on your telephone.
2. Enter the Configuration access code:

Feature	*	*	C	O	N	F	I	G
---------	---	---	---	---	---	---	---	---

 which is the same as

Feature	*	*	2	6	6	3	4	4
---------	---	---	---	---	---	---	---	---
3. The display shows Password:.
 Enter the Configuration password (the password does not appear on the display as you enter it). The default Password is **CONFIG** (266344).

 If the password is correct, the display shows **A.Configuration**, and three triangular indicators ► appear on the vertical display between the rows of buttons.

 If the password is incorrect, the display does not change. Check the password. Press **RETRY** and re-enter the password.
4. Place the *Norstar* Programming Overlay over the buttons pointed to by the indicators . .

Exiting Configuration

Norstar stores your changes automatically as soon as you alter any settings; you do not need to “save” your changes.

1. Press

Rls

.
 The display briefly shows End of session.

Configuration headings

Headings and subheadings in Configuration programming help you to keep track of where you are. An example of a heading is **1. Trk/Line data** for programming trunks and lines. Under that heading, one of the subheadings is **Dial mode** for programming the dial mode of a line.

Configuration programming has five headings:

CONFIGURATION CODE



Password:



A. Configuration



1. Trk/Line Data



2. Line Access



3. Call Handling



4. Miscellaneous



5. System Data

Trk/Line Data lets you assign settings to each trunk, external line and incoming target line.

Line Access lets you assign settings to each telephone.

Call Handling lets you assign system-wide settings associated with various call features.

Miscellaneous lets you assign various system-wide settings.

System Data lets you change a telephone's internal number, the length of all internal numbers, and the number of digits received by auto-answer trunks.

Moving through Configuration

To program a setting, you must first locate the correct heading. To do this, scan through the headings of Configuration using the and [Back] buttons.

To move through Configuration headings:
Begin with the display showing **A. Configuration**.

1. Press .
The display shows **1. Trk/Line Data**.
2. Press [Next].
The display shows **2. Line Access**.
3. Press .
The display shows **3. Cal 1 Handling**.
4. Press .
The display shows **4. Miscellaneous**.
5. Press [Next].
The display shows **5. System Data**.
6. Press .
The display shows **1. Trk/Line Data**.

Using the Overlay

The indicators show which buttons can be used at that programming step. The functions on these buttons allow you to move through the headings and subheadings of Norstar programming.

- | | |
|-----------|---|
| [Heading] | moves up in the hierarchy of headings and subheadings. |
| Show | moves down in the hierarchy of headings and subheadings, or to begin programming for a heading or subheading. |
| Next | moves to the next heading, subheading, or setting. |
| Back | moves to the previous heading, subheading, or setting. |

The Norstar Programming Overlay is located inside the back cover of this Guide.

M7310 Telephone with a **Norstar** Programming Overlay

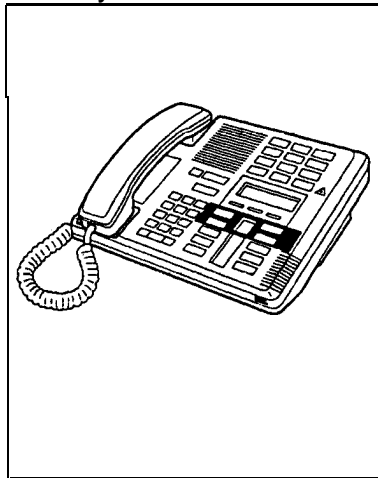

M7324 Telephone with a **Norstar** Programming Overlay

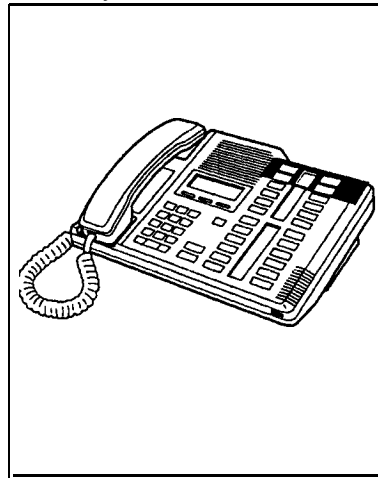

The Norstar display buttons

Display buttons perform many functions. Depending on where you are in programming, one, two, or three display buttons may be available at any one time. You press one of the display buttons to select the function that you want.

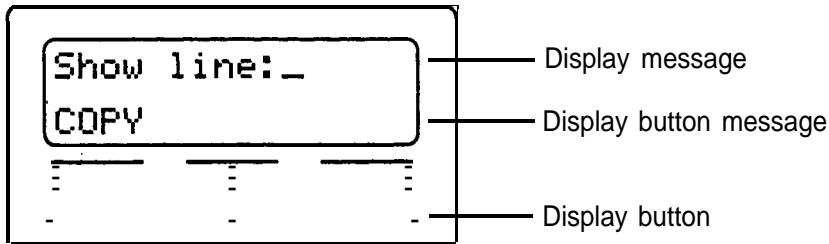

The most common display button labels are:

- CHANGE** changes a programmable setting.
- BKSP** moves the cursor one space to the left (backspace) and delete a character, allowing you to re-enter a number or letter.
- COPY** copies line or telephone programming.
- VIEW→** views the last part of a displayed message longer than 16 characters.
- ←VIEW** views the first part of a displayed message longer than 16 characters.
- ==>** moves the cursor one position to the right when programming a name.
- <==** moves the cursor one position to the left when programming a name.

Programming details

Entering numbers

Numbers are entered from the Norstar telephone dial pad. The backspace display button may be used to edit the number.

A line number must always be entered as a three-digit number. Line numbers from 10 to 99 must be entered with a leading zero (line 020, for example). Similarly, line numbers less than 10 must be entered with two leading zeros (line 002, for example).

Internal telephone numbers, also referred to as Directory Numbers (DNs), can be two- to seven-digits long on a non-expanded system, and three- to seven-digits long on an expanded system. The default DN length is two on a non-expanded system and three on an expanded system. The DN length can be changed in Configuration programming.

Viewing long telephone numbers

External telephone numbers can be up to 24 digits, but the telephone display is only 16 character spaces long. If you wish to see a previously programmed number that is longer than 16 digits, you must do the following:

Begin, for example, with 123456789812345.

The display shows only the first 15 digits. The three dots (...) at the end of the display indicate th'at more digits remain to the external number.

1. To see the remaining digits, press **VIEW**.
2. To see the first 15 digits again, press **←VIEW**.

Trk/Line Data

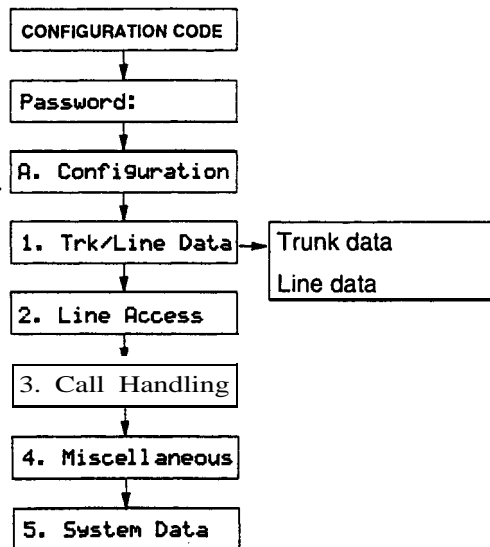

Trunk lines and Target lines

In order to configure a Norstar system, you need to distinguish between trunks and target lines.

A trunk is a physical line numbered from 001 to 080 (in a fully expanded system).

A target line is a 'virtual' communication path between an external caller and a Norstar telephone (or other Norstar device). This path is established on the basis of digits received from an incoming trunk. Target lines number from 081 to 184 (in a fully expanded Norstar system).

Having target lines, independent of the physical lines, makes it possible to have many target lines for a few physical trunks. Telephones can be configured to have an appearance of any type of line (including target lines). Calls may be placed on all lines except target lines.

Note: See the description of Line Pool programming under the Line **type** setting (in 1. **Trk/Line** Data, Line data) for the recommended assignments to line pools.

Line numbers for Trunks and Target lines

Type of system	KSU trunks (loop start)	Trunk Module trunks	Target lines
Non-expanded system	001 — 008	none	none
2-port Expansion Cartridge	001 — 008	009 — 032	081 — 120
6-port Expansion Cartridge	001 — 008	009 — 080	081 - 1 8 4

Trunks

A trunk provides the physical connection between a Norstar system and other systems (Norstar or otherwise) in a private or public network. Norstar uses three types of trunks:

- loop start trunks
- E&M trunks
- Direct Inward Dial (DID) trunks

Loop start and E&M trunks can be used for both incoming and outgoing calls. DID trunks, however, are used for incoming calls exclusively.

Loop start and E&M trunks operate in one of two modes for incoming calls: manual-answer or auto-answer. DID trunks operate only in auto-answer mode.

Manual-answer trunks

Incoming calls on trunks configured for manual-answer alert in the usual manner at all associated line appearances.

Auto-answer trunks

Trunks configured for auto-answer provide remote access to the system. Any line appearance of such a trunk is normally used only to monitor the incoming call status of the trunk, not to answer calls.

Incoming calls on auto-answer trunks are answered by the system. Typically, digits received from the far end are used to route the call to a specific target line.

If they are idle, auto-answer loop start and E&M trunks can be used to make outgoing calls.

Disconnect supervision

Supervision is a feature available on a CO line. You should only use the disconnect supervision setting for lines that have the Supervision feature.

Disconnect supervision is required for auto-answer trunks, but not for manual-answer trunks. Note, however, that use of unsupervised trunks (or trunks with disconnect supervision inactive) for incoming calls results in the inconsistent operation of the Line Redirection feature, the ability to tandem through the Norstar system to other systems in the network, and the ability to disconnect from a conference that involves two external callers.

Note: If a Norstar trunk without disconnect supervision is programmed for auto-answer mode, the trunk operates in manual-answer mode.

Loop start trunks

Both manual-answer and auto-answer trunks can be used for making outgoing calls or receiving incoming calls. The answer mode (manual-answer and auto-answer) determines how the system handles incoming calls.

By default, auto-answer Loop start trunks are answered by the system DISA (Direct Inward System Access) capability, and are used to provide controlled access to a Norstar system's resources from the public network.

A user makes or receives calls on a manual-answer Loop start trunk by having a line appearance of the trunk, or by selecting a line pool containing the trunk to make a call.

Note: KSU trunk lines (001 to 008) are Loop start lines.

E&M trunks

E&M trunks connect two or more systems directly in a private network.

An E&M Trunk Cartridge provides two E&M trunks and two DTMF receivers. These are given consecutive line numbers. For example, an E&M TC in slot 1 of a Trunk Module plugged into the highest numbered DS-30 port shows the E&M trunks as lines 009 and 010, and shows the DTMF receivers as line numbers 011 and 012.

E&M trunks can operate in manual-answer mode, or in auto-answer mode with disconnect supervision. Manual-answer E&M trunks alert directly at any telephone with a line appearance associated with the trunk. By default, auto-answer E&M trunks are answered by the system DISA (Direct inward System Access) capability, and are used to provide controlled access to a Norstar system's resources from elsewhere in a private network.

Capabilities available to a remote user are determined by a Class of Service associated with the trunk or by the remote user's DISA password,

Direct Inward **Dial#** (DID) trunks

DID trunks handle only incoming external calls. The digits received from the Central Office are used typically to route calls to a target line. The DID call appears at every telephone configured with an appearance of that target line.

Calls can also be made to the DISA DN or the Auto DN, if the last digits of the DID number are the same as one of these DNs.

Any appearance of a DID trunk can be used only to monitor activity of the trunk, not to answer an incoming call.

Note: The digits provided by the CO need not match the Norstar numbering plan. You can use the Configuration **Rec'd #: _** heading to specify the digits that make a target line ring. You can use the Configuration DISA DN or Auto DN settings to specify the numbers that make the system answer a remote call automatically.

Target lines

A target line is a specific communication path reached by means of digits received from an incoming trunk. Target lines are used to answer incoming calls but cannot be used to make outgoing calls.

Auto-answer loop start and E&M trunks, and DID trunks, provide automated routing of calls to different destinations depending on the digits dialed. The destination is usually a target line (a virtual line) that can be assigned to telephones in the same way as a physical line. Target lines provide for attendant by-pass (calling directly to a specific department or individual) and line concentration (one trunk can fan out into many target lines).

The digits received on an incoming trunk may be:

- received from a Central Office (in the case of DID)
- received from a PBX (in the case of E&M)
- dialed by a remote user after having received system dial tone (in the case of auto-answer loop start, auto-answer E&M trunks or DID trunks).

By default, no target lines are assigned. However, if auto-answer trunks are used in the system, you can assign target lines to sets in the same way that other lines are assigned (in 2. Line **Access** of Configuration).

Target lines are referred to by line numbers in the same way as physical lines.

Remote system access

The remote access feature allows callers elsewhere on a private network, or on the public network, to get access to a **Norstar** system by dialing directly without going through an attendant. Once on the system, the remote user can use some of the system's resources.

Norstar systems with at least one Trunk Module support remote system access on the following trunk types which may require the remote caller to enter a password for Direct Inward System Access (DISA):

- auto-answer loop start trunks
- auto-answer E&M trunks
- DID trunks (by means of the DISA DN).

The system resources (dialing capabilities, Line Pool access and feature access) that a remote user may access depends on the Class of Service assigned to them. You can refer to the description of Class of Service in the Administration chapter for more details.

Remote access on loop start and E&M trunks

Loop start trunks provide remote access to **Norstar** from the public network; E&M trunks provide remote access from a private network. Each must be configured to be auto-answer (in Trunk **data** programming) to provide remote system access.

A loop start trunk must have disconnect supervision if it is to operate in auto-answer mode. E&M trunks always operate in disconnect supervised mode.

Auto-answer with **DISA**

When a caller dials in, the system answers with stuttered dial tone. This is the prompt to enter a Class of Service (COS) password which determines which system capabilities are available to the caller.

Auto-answer without DISA

When a caller dials into the system, the system answers with system dial tone and no COS password is required. In this case, control over the system capabilities available to the caller is provided only by the Class of Service assigned to the incoming line.

Remote access on E&M trunks connected to a private network

Nodes on the private network deliver the last dialed digits to the destination Norstar node, for interpretation by the destination Norstar node. The destination Norstar node either matches the digits to a target line or interprets the digits as a remote feature request. The call is either routed to the specified target line, or the remote feature is activated.

Auto-answer E&M trunks connected to a private network

By default, E&M trunks are set to answer with DISA. For auto-answer E&M trunks connected to a private network, change the default so that the trunks are not answered with DISA.

If an auto-answer E&M trunk is configured to answer with DISA, the system tries to interpret any received digits as a COS password.

Auto-answer with the DISA DN and the Auto DN

The DISA DN and the Auto DN allow auto-answer private network and auto-answer DID calls, in the same way that calls on auto-answer loop start and auto-answer E&M trunks can be answered, with or without DISA. These DNs are described in 4. **Miscellaneous** programming.

Remote access on Direct Inward Dial (DID) trunks

Remote system access on DID trunks is similar to that of E&M trunks connected to a private network. The main differences are:

- a remote caller is on the public network dialing standard local or long-distance telephone numbers
- the digits received are delivered by the Central Office (CO)
- DISA cannot be administered to a DID trunk.

As with a private network, the dialed digits may be programmed to match those of a specific target line DN or Remote Feature DNs (the DISA DN and the Auto DN).

Copying Trunk and Line data

At the Show 1 line: — prompt a **COPY** button appears. This allows you to copy programming from one line to other lines.

Copying data from different types of Trunk Cartridges (TC)

Copying lines between different trunk types (for example, from a Loop Start TC to an E&M TC) triggers the prompt Reset **nnn-mmm?**, along with the display buttons **YES** and **NO**. This is because all trunks on a given TC must be of the same type. Changing the trunk type for one line on a TC changes all lines on the same TC.

Note: “nnn-mmm” is the number range for the lines in the Trunk Cartridge to which the data is to be copied.

Copying limitations

- when copying data for an E&M line to a loop start line or a DID line, if you reset the new line to E&M (in response to the prompt), the first two lines in the changed TC are E&M and the last two lines DTMF (see the description of E&M Trunks).
- in copying data from a physical trunk to a target line (or the other way around), only the data in common is copied. For example, copying a target line to an E&M trunk copies only the Line data settings because there are no Trunk data settings for a target line.
- the Received number (**Rec'd #:**) of a target line is a unique number and cannot be copied.
- the two lines on E&M TCs reserved for DTMF receivers cannot be copied to another line type (see the section on E&M TCs for a description of E&M and DTMF lines).
- You can copy data to KSU lines 001 to 008 only from loop start lines.

Trunk data

Trunk Data settings apply to physical lines (001 to 080), and not to target lines (081 to 184). Some Trunk Data settings may not appear on the display during programming depending on the type of trunk. Those that appear for a given Trunk type are indicated in the table below.

Note: Target lines do not have any Trunk data settings. For target lines, the physical connection information consists of the received digit string (**Rec'd #:**) used to access the target line.

Trunk data prompts that appear for a given Trunk type

Prompt	Loop start	E&M	DID	DTMF
Line<nnn>:	Yes	Yes	Yes	Yes
Trunk mode:	Yes	—	—	—
Ans mode:	Yes	Ye8	—	—
Ans with DISA:	Yes	Yes	—	—
Signal:	—	Yes	Yes	—
Gain:	—	Yes	—	—
Dial mode:	Yes	Yes	—	—
Full AutoHold:	Yes	—	—	—

Line<nnn>

The Line setting specifies the trunk type for a line. Use the **CHANGE** display button to select the setting: Loop, E&M (or DTMF) and DID.

Loop is the default setting used for loop start trunks (for Loop Start and CI Trunk Cartridges), and for KSU loop start lines (001 to 008).

E&M is for the first two line numbers on an E&M Trunk Cartridge .

DTMF is for the two last lines on an E&M cartridge. You must not assign DTMF receiver line numbers to telephones. If you do, the lines appear at the telephone as out of service.

DID is for a Direct Inward Dialing (DID) Trunk Cartridge.

Programming hints

- E&M Trunk Cartridges have two E&M lines and two DTMF receivers (instead of four lines as in a loop start cartridge). For example, if an E&M Trunk Cartridge has the range of line numbers 009 to 012, numbers 009 and 010 are E&M lines, and numbers 011 and 012 are the DTMF receivers. The display prompt for line 010 appears as **Line010: E&M** and for line 011 appears as **Line011: DTMF**.
- After you change a Trunk type setting (or after you use the **COPY** display button to copy Line programming) you are prompted to confirm that you want to reset the Trunk type for all trunks supplied by the TC, since all trunks on the same TC must be of the same type. You must press the **YES** display button for a changed or copied Trunk setting take effect.

Note; Changing the settings for Trunk Cartridge type (that is, loop start, E&M or DID) on a system in use, may cause lines to be disabled and calls to be dropped.

Trunk mode

Trunk mode lets you specify one of two modes of operation for each line: disconnect supervision or unsupervised. Disconnect supervision, also referred to as loop supervision, releases an external line when an Open Switch Interval (OSI) is detected during a call on that line. This prevents the line from remaining unavailable for other Norstar users.

Use the **CHANGE** display button to select the setting: Super or Unspr.

Super assigns supervised mode, if supported by the Norstar hardware; otherwise, unsupervised mode is assigned.

Unspr (the default) turns disconnect supervision OFF for the line.

Programming hints

- The Trunk mode setting is used only for loop start lines on a Trunk Cartridge or in the KSU.
- The duration of an OSI before Norstar disconnects a call is programmed in the Supervision setting of Miscellaneous programming.
- For loop start trunks to operate in auto-answer mode, disconnect supervision is required.

Answer mode

The Answer mode prompt appears on the display during programming for loop start lines if the Trunk mode setting was Super, and for E&M lines. The prompt is suppressed for DID programming. Use the **CHANGE** display button to select the setting: Manual or Auto.

Programming hints

- Remember that disconnect supervision is required if loop start trunks are to operate in auto-answer mode.
- You should change the Answer with DISA setting to N, for E&M trunks in a private network operating in auto-answer mode. The default (**Ans with DISA: Y**) causes the system to expect a Class of Service password after it automatically answers a trunk.

Answer with **DISA**

When activated, the Answer with DISA setting specifies that a trunk is answered with stutter dial tone. Use the **CHANGE** display button to select the setting: Y (Yes) or N (No).

Programming hints

- This setting is displayed during the programming of loop start and E&M lines if Answer mode was set to Auto. The prompt is suppressed during DID programming.

Signal

Use the **CHANGE** display button to select the setting: **WinkStart**, **Immediate** and **DelayDial**.

Programming hints

- The Signal setting appears on the display only for E&M or DID programming.
- Make sure that this matches the signal type programmed for the trunk at the other switch.

Gain

Use the **CHANGE** display button to select the setting: Normal or High. The default value Normal induces zero loss. Use it when the E&M trunks are connected to facilities that present 0 dBm at the interface, for both the transmit and receive paths.

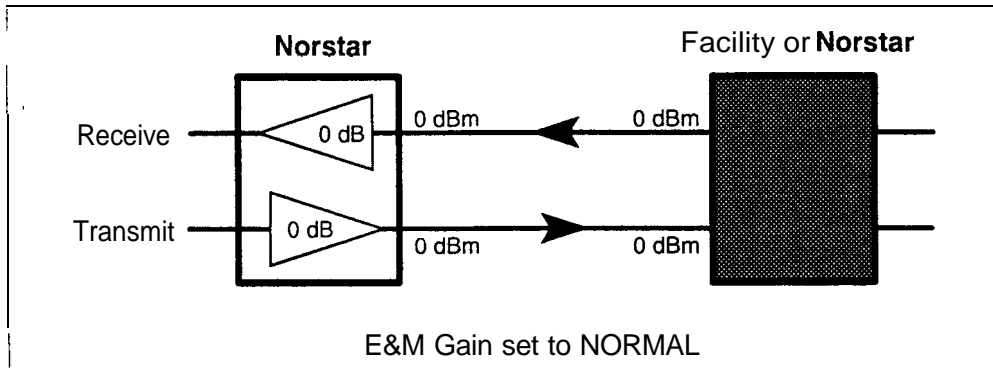

The value High induces 7db of loss in the receive path and 16db of loss in the transmit path. Use it when the E&M trunks are connected to facilities that present +7 dBm in the receive path, and -16 dBm in the transmit path, at the interface.

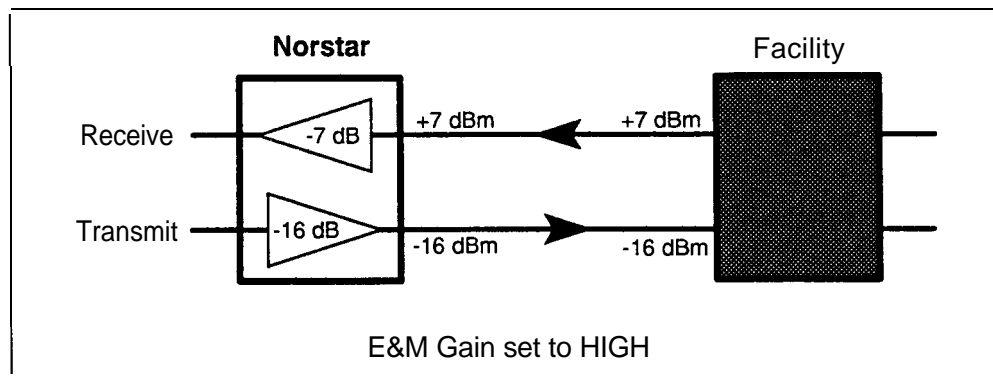

Programming hints

- Control over the gain (transmission levels) can be set for E&M trunk programming only.

Dial mode

The Dial mode setting appears on the display only for loop start and E&M trunk programming. Dial mode lets you specify whether Dual Tone Multi-Frequency (DTMF) or Pulse signalling is used on the trunk. Use the **CHANGE** display button to select the setting: Pulse or Tone.

Full **Autohold** on idle line

Full Autohold on idle line is a variation of the Automatic Hold feature. If you select an idle line, but do not dial any digits, that line is automatically placed on hold if you then select another line. Use the **CHANGE** display button to select the setting: N (No) or Y (Yes).

The line you first selected is held until you press its button, The line is not available for use by anyone else.

Programming hints

- A prompt for Full AutoHold appears only during loop start trunk programming. Full AutoHold is always in place for E&M trunks; it has no meaning for incoming-only DID trunks.
- The default setting should be changed only if Full Autohold is required for a specific application.

Received number

The Received number setting applies only to target lines (line numbers 081 and higher). It allows you to specify the digits which make a specific target line ring. The default value is no digits specified.

Use the **[Show]** button, the **CHANGE** display button, and the dial pad to program the digit string for each target line.

Programming hints

- The length of a **Rec'd #:** can be one to seven digits (programmed in System Data); the default is three digits.
- Received numbers must be unique among target lines, the Auto DN, the DISA DN and the Line Pool access codes.

Line data

Line data programming can be applied to all lines, trunks and target lines:

- lines 001 to 032 (trunks) and 081 to 120 (target line) for a Two-port Expansion Cartridge.
- 001 to 080 (trunks) and 081 to 184 (target lines) for a Six-port Expansion Cartridge.

Line type

This setting specifies how the line is to be used in relation to other lines in the system. Use the **CHANGE** display button to select the setting: Public, Private to:, or Pool (A to 0, representing 15 line pools).

A Public line can be accessed by more than one telephone.

A Private line can be assigned only to one telephone and the Prime Telephone for that line. Use the **CHANGE** display button and the dial pad to enter the internal number of the telephone.

Pool assigns the line to one of the fifteen line pools. If a line is assigned to a line pool, but is not assigned to any telephone, that line is available only for outgoing calls.

Programming hints

- Line pools must NEVER contain a mixture of loop start lines and E&M lines.
- All lines in a given line pool should always go to the same location.
- There are two more programming settings that must be assigned before a line pool can be used:
 - | You must assign Line Pool access to telephones in the Line Access section of Configuration programming.
 - | You must assign system-wide Line Pool access codes in the Miscellaneous section of Configuration programming.
- A telephone can be administered to search automatically for an idle line from several lines appearing on the telephone. Assign a line pool as the Prime line (in 2. **Line Access, Prime 1 line**) and all the lines in the line pool must appear on that telephone. When the user lifts the receiver, or presses handsfree, any one of the lines, if idle, can be selected by Automatic Outgoing Line selection.
- Develop a unified dialing plan for line pools where Norstar systems are networked together. It may be appropriate to provide a single line pool with E&M lines for use by all callers on the network.
- If you plan to program the Prime line to the Intercom (I/C) setting, you may wish to assign loop start lines to the first line pools. Remember that when the system searches for an outgoing line, it begins at Line Pool A and chooses the first available line.
- Assigning a single E&M trunk to a line pool allows features like Ring Again on Busy Line Pool to help manage access to a shared resource.
- Target lines cannot be assigned to a line pool.

Prime Telephone

This feature allows you to assign a telephone to provide backup answering for calls on the line. Unanswered calls are redirected to the Prime telephone. Use the **CHANGE** display button and the dial pad to enter the internal number of the Prime telephone.

Programming hints

- For auto-answer trunks, calls ring only at the Prime telephone for a trunk, and only when overflow call routing is active.
- Each line can be assigned only one Prime telephone.

Auxiliary Ringer

This setting allows you to turn the Auxiliary Ringer ON or OFF. When turned ON, the Auxiliary Ringer ring for any incoming calls that ring on the line. The Auxiliary Ringer is an optional device that must be connected by the Installer. Use the **CHANGE** display button to select the setting: Y (Yes) and N (No).

Programming hints

- For auto-answer trunks, calls ring only at the Prime telephone for a trunk, and only when overflow call routing is active.
- An Auxiliary Ringer can be programmed, in the Service Modes section of Administration programming, to ring for a line placed into a Service Mode. An Auxiliary Ringer can also be programmed to ring for calls to a telephone. See the System Coordinator Guide for more information.

Privacy

This feature controls whether one Norstar user can select a line in use at another telephone to join an existing call. The default setting is Privacy ON, so that nobody with a Norstar telephone can press a line appearance on their telephone to join a call in progress at another telephone. Use the **CHANGE** display button to select the setting: Y (ON) and N (OFF).

Programming hints

- Privacy can also be turned ON and OFF during a call with the Privacy feature code.

Line Access

When you are finished programming Line Access settings for one telephone, you can copy those settings to other telephones.

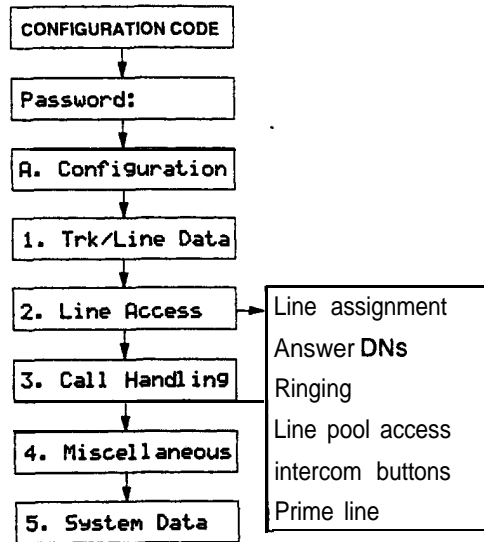

Line assignment

This setting allows you to assign physical trunk lines and target lines to each telephone. Target lines are assigned and removed in the same manner as other lines. Use the **Show t t** o n , the **ADD** display button, and the dial pad to program the line numbers each telephone can access.

Programming hints

- The default line assignments depend on the system template assigned during System Startup. The line assignment defaults for the default template (Square) are lines 001 and 002 to all telephones.
- In general, auto-answer loop start trunks, auto-answer E&M trunks and DID trunks are not assigned to telephones. If assigned, they are used for monitoring incoming call usage, or for making outgoing calls (auto-answer loop start and E&M trunks).
- You cannot add a line that is private to another telephone.
- Each line assigned to a telephone must appear at a button with an indicator on that telephone. The maximum number of line buttons are:
 - 8 for the M7208 Telephone
 - 10 for the M7310 Telephone
 - 24 for the M7324 Telephone
- The M7100 Telephone is an exception; it has no line buttons and can be assigned any number of lines.
- A Central Answering Position (CAP), with one or two CAP modules, can provide extra line buttons if more than 12 lines are assigned to the M7324 Telephone. The remaining lines appear at buttons on the first CAP module.

Answer DNs

Calls for other Norstar telephones can appear and be answered at the telephone being programmed. The DNs of the other telephones are referred to as Answer DNs. One to four Answer DNs may be assigned to the telephone being programmed. Use the button, the **ADD** display button, and the dial pad to program the line numbers each telephone can access on an Answer button.

Programming hints

- Every Answer DN assigned to the telephone automatically assigns an Answer button with an indicator to the telephone. These buttons should be labeled accordingly, identifying the telephone with its name or DN.
- More than one telephone can have an Answer button for the same DN. In this way, more than one telephone can provide call alerting and call answering for any calls directed to that DN.
- A Private line does not generate alerting at an Answer button.

Ringling

This setting allows you to choose:

- which lines (including target lines), on the telephone being programmed, rings for an incoming call.
- which Answer DNs, on the telephone being programmed, rings for an incoming call.

If auto-answer loop start trunks, auto-answer E&M trunks or DID trunks are assigned to a telephone, the ringing preference has an effect only when overflow call routing or callbacks associated with overflow call routing occur. The ring/no ring setting has no effect on incoming calls on the trunks that are being routed to target lines.

Use the **Button** to display the line you want to program ringing for. Use the **CHANGE** display button to select the setting: Ring and No ring.

Programming hints

- Refer to Startup for default line ringing assignments in the the Square, Centrex, Hybrid and PBX system templates.
- Ensure that lines assigned to an M7100 Telephone Ring; otherwise incoming calls on the lines cannot alert at the telephone.
- You cannot program Ringling if there are no lines or Answer DNs assigned to the telephone.

Line Pool access

This setting allows a telephone to access one or more of the fifteen line pools available (A to 0). When you assign “yes” for a, given line pool, the telephone being programmed can access any lines in that line pool.

Use the SHOW to display the line pool you want to program access to. Use the CHANGE display button to select the setting: N (No) and Y (Yes).

intercom buttons

This setting assigns the number of Intercom buttons to a telephone. Intercom buttons provide a telephone with access to internal lines. Use the CHANGE display button to select the setting: 0, 1, 2, 3, 4, 5, 6, 7, or 8.

Programming hints

- Each Intercom button assigned during programming automatically appears on the telephone. The buttons start with the lower right-hand button, or one button above if the **Handsfree/Mute** feature was assigned to the telephone.
- Two Intercom buttons are required for establishing a conference call with two other Norstar telephones.
- Only one Intercom button is required if internal calls are to be made or received on the telephone, and line pools are to be accessed.
- The M7100 Telephone default assignment of two Intercom buttons cannot be changed. These buttons do not appear on the telephone.

Prime line

This setting assigns a Prime line to the telephone. A Prime line is the first line that is automatically selected when a call is made from a Norstar telephone. Use the **CHANGE** display button to select the setting: None, a line number, Pool (A to 0), and I/C. (Only assigned lines and line pools appear.)

Programming hints

An assigned Prime line is not associated with the assignment of a Prime telephone.

An external line must be assigned to the telephone in Line assignment before it can be assigned as the Prime line to the telephone.

A line pool must be assigned to the telephone in Line Pool access before a line pool can be assigned as the Prime line to the telephone.

- A target line cannot be a Prime line for a telephone because it is incoming-only.
- A DID line should not be assigned as the Prime line for a telephone. If assigned, it is treated as if no Prime line has been assigned. The message **Select a 1 line** appears when the receiver is lifted.

Remember that if you set Prime line to Intercom (I/C), you may wish to assign loop start lines to the first line pools. Remember that when the system searches for an outgoing line, it begins at Line Pool A and chooses the first available line.

By assigning a line pool as a Prime line, a telephone can be made to search automatically for an idle line in a pool. This is described in the section on programming Line type (1. **Trk/Line** Data, Line data).

Call Handling

Call Handling allows you to program system-wide characteristics. These characteristics are not associated with any specific line or telephone.

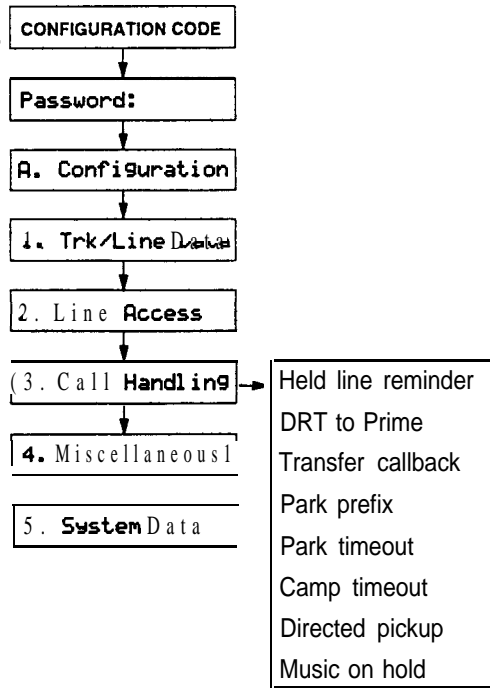

Held Line Reminder

When active, Held Line Reminder reminds you that a call at your telephone is still on hold. You periodically hear two tones from your telephone until you return to the call on hold. Use the **CHANGE** display button to select the setting: N (No) or Y (Yes).

Held Line Reminder delay

Held Line Reminder delay allows you to choose the number of seconds before the Held Line Reminder feature begins at a telephone that has an external call on hold. Use the **CHANGE** display button to select the setting: 30, 60, 90, 120, 150, or 180 seconds.

Programming hints

- The Held Line Reminder delay can be programmed only if Held Line Reminder is activated.

Delayed Ring Transfer

Delayed Ring Transfer automatically forwards unanswered external calls to a Prime telephone, after a certain period of time. This helps ensure that no external call goes unanswered. Use the CHRNQE display button to select the setting: Y (Yes) or N (No).

, Programming hints

- An operational Prime Telephone must be assigned before this feature can operate. A Prime Telephone is assigned to one or more external lines in the Line Data section of Configuration programming.

Delayed Ring Transfer delay

Delayed Ring Transfer delay allows you to specify the number of rings before Delayed Ring Transfer transfers a call to a Prime telephone. Use the CHANGE display button to select the setting: 1, 2, 3, 4, 6, or 10 rings.

Programming hints

- The Delayed Ring Transfer delay can be programmed only if Delayed Ring Transfer is activated.
- You can estimate the delay in seconds if you multiply the number of rings by six.

Transfer Callback delay

Transfer Callback delay allows you to specify the number of rings before a Callback occurs on a transferred call. Use the CHANGE display button to select the setting: 3, 4, 5, 6, or 12 rings.

Programming hints

- You can estimate the delay in seconds if you multiply the number of rings by six.

Park prefix

The Park prefix is the first digit of the call park retrieval code that must be entered to retrieve a parked call. If the Park prefix is set to None, calls cannot be parked. Use the CHANGE display button to select the setting: 1 to 9, N (None), or 0.

Programming hints

— The Park prefix cannot be the same as:

- the Direct-dial digit
- the External Line access code
- the first digit of a DN
- the first digit of a Line Pool access code.

Other programmable settings may affect which numbers appear on the display during programming . Although the numbers 0 to 9 are valid Park prefix settings, some may have been already assigned elsewhere by default or by programming changes. (To avoid a conflict, refer to the table of default settings in the description of External code.)

— If DN length is changed, and the changed DNs conflict with the Park prefix, the setting changes to `None`.

Park timeout delay

Park timeout delay allows you to assign the number of seconds before a parked call on an external line returns to the originating telephone. Use the **CHANGE** display button to select the setting: 30, **45**, 60, 90, 120, 150, 180, 300, or 600 seconds.

Camp timeout delay

Camp timeout delay allows you to assign the number of seconds before an unanswered camped call is returned to the telephone which camped the call. Use the **CHANGE** display button to select the setting: 30, 45, 60, 90, 120, 150, or 180 seconds.

Directed pickup

Directed pickup allows you to answer any calls by specifying the ringing telephone's internal number. Use the **CHANGE** display button to select the setting: Y (Yes) or N (No).

Programming hints

- Directed pickup is not to be confused with the Call Pickup “Group” feature in Administration programming, which allows you to answer a call at any telephone within a specific group without specifying the internal number of the ringing telephone.
- Like Call Pickup Group, Directed pickup is useful when not all the telephones, have been assigned the same lines, but you still want to allow your co-workers to answer a call on any external line from their telephones.

On hold

On hold allows you to choose what a caller hears on an external line when the line has, been put on hold. Use the **CHANGE** display button to select the setting: Tones, Music, or Silence.

Tones provides a periodic tone.

Music provides any signal from a source such as a radio connected to the KSU.

Silence provides no audio feedback.

Miscellaneous

Miscellaneous allows you to program system-wide characteristics. These characteristics are not associated with any specific line or telephone.

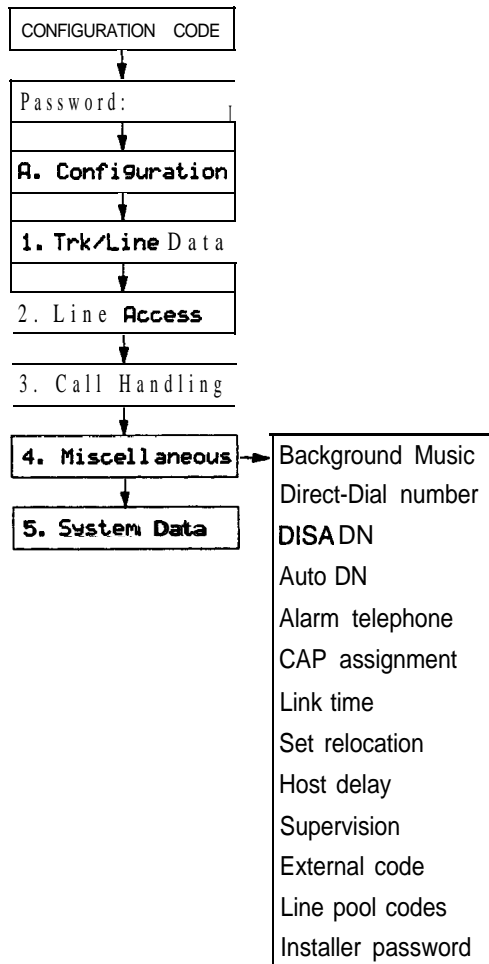

Background Music

Background Music allows you to listen to music through your telephone speaker. A music source must be connected to the Key Service Unit. Use the **CHANGE** display button to select the setting: N (No) or Y (Yes).

Direct-dial digit

Direct-dial digit allows you to dial a single system-wide digit that can be used to call a specific telephone, called a Direct-dial telephone. Use the **CHANGE** display button to select the setting: 0 to 9, or N (None).

Programming hints

- There can be as many as five Direct-dial telephones in a system. The Direct-dial telephone to which specific telephones connect is assigned in Administration (4. Direct-Dial and 5. **Capabilities**).
- People with common interests should be in the same Direct-dial group. For instance, the secretary who can best handle calls or questions for a group could have a telephone assigned as the Direct-dial telephone for that group.
- Another Direct-dial telephone, an Extra-dial telephone, can be assigned for each Service Mode in Service Modes programming.
- The Direct-dial digit cannot be the same as:
 - the first digit of a DN
 - the first digit of a Line Pool access code
 - the External Line Access code
 - the Park prefix

To avoid a conflict, refer to the table of default settings in the description of External code.

- If DN length is changed, and the changed DNs conflict with the Direct-dial digit, the setting changes to N.

Direct Inward System Access Directory Number (DISA DN)

For calls answered with DISA, the system presents a stuttered dial tone to prompt a caller to enter a valid password. The Class of Service (COS) that applies to the call is determined by this COS password.

- If a remote user is on the Norstar system, the DISA DN can be used to change the existing Class of Service.

Use the CHANGE display button and the dial pad to enter the digits to be received from the auto-answer trunk. Use the button to set the DISA DN to None.

Programming hints

- The length of the DISA DN is the same as the Rec'd # 1 length specified in 5. System Data. The DISA DN is cleared if the Received number length is changed.
- The DISA DN cannot conflict with any target line DNs, and cannot have a first digit that conflicts with the first digit of a Line Pool access code or with the External Line access code.

Auto Directory Number (Auto DN)

For calls answered without DISA, no password is required to access the Norstar system. The Class of Service (COS) that applies to the call is determined by the COS for the trunk on which the user is calling.

Use the CHANGE display button and the dial pad to enter the digits to be received from the auto-answer trunk. Use the button to set the Auto DN to None.

Programming hints

- The length of the Auto DN is the same as the Rec'd # 1 length specified in 5. System Data. The Auto DN is cleared if the Received number length is changed.
- The Auto DN cannot conflict with any target line DNs, and cannot have a first digit that conflicts with the first digit of a Line Pool access code or with the External Line access code.

Alarm telephone

Alarm telephone allows you to assign a telephone on which Alarm messages appear when a problem has been detected in the system. Use the CHANGE display button and the dial pad to enter the internal number of the Alarm telephone. Use the Show button to set the Alarm telephone to None. The default setting is 221.

CAP (Central Answering Position) assignment

This setting designates a telephone as a CAP. The CAP must be an M7324 Telephone, and may have one or two CAP modules attached. A maximum of five CAPs can be installed in a Norstar system.

The CAP may be used to:

- monitor the busy/not busy and Do Not Disturb status of Norstar telephones
- answer external calls on up to 120 lines, and extend calls to other Norstar telephones
- send up to 30 messages to other Norstar telephones
- provide up to 96 extra memory buttons for the M7324 Telephone.

Use the Show button, the CHANGE display button and the dial pad to enter the internal number of the M7324 Telephone to be designated a CAP.

Programming hints

- If CAP modules are attached to an M7324 Telephone that has not been programmed as a CAP, then no CAP settings are assigned.
- If a CAP module (or modules) is relocated with the M7324 Telephone, the settings are retained.

Link Time

Link Time allows you to specify the duration of a signal required to access a feature through a remote system. Use the **CHANGE** display button to select the setting: 100, 200, 300, 400, 500, 600, 700, 800, 900, or 1000 milliseconds.

For example

External dialing must reach through a Centrex system. The Centrex system requires a Link Time of 400 ms. Program a Link Time of 400.

Programming hints

- The Link Time required depends on the requirements of the host switching system that must be accessed.
- Link is another name for recall or flash.

Telephone Relocation

Telephone Relocation allows you to move any telephone to a new location within the Norstar system without losing Personal programming, and any Configuration and Administration programming for that telephone. Use the **CHANGE** display button to select the setting: N (No) and Y (Yes).

Programming hints

- It is advisable to activate Telephone Relocation after the telephone installation and programming has been done. This provides you with more flexibility in testing equipment.
- If this feature is deactivated while a telephone is moved, that telephone's internal number and Administration data remain with the physical port on the KSU, and the telephone does not receive the original programming when it is reconnected elsewhere.

Host delay

Host delay lets you assign the delay between the moment an outgoing line is selected to make an external call (by lifting the receiver off the telephone, for example) and the moment that Norstar sends dialed digits or codes on the line. Use the **CHANGE** display button to select the setting: 200, 400, 600, 800, 1000, 1200, 1400, 1600, 1800, or 2000 milliseconds.

Programming hints

- Host delay is provided to ensure that a dial tone is present before the dialing sequence is sent. Minimizing this delay provides faster access to the requested features.

Disconnect Supervision delay

Disconnect Supervision delay allows you to specify the duration of an Open Switch Interval (OSI) before the Disconnect (or loop) Supervision feature disconnects a call on a supervised external line. Use the **CHANGE** display button to select the setting: 60, 100, 260, 460, or 600 milliseconds.

Programming hints

- Disconnect Supervision is assigned to each line with the Trunk mode setting in the Line Data section of Configuration programming.

External code

External code allows you to assign the External Line access code. This code is used to allow **M7100** Telephones and Analog Terminal Adapters (**ATA**) to access external lines.

Use the **CHANGE** display button and the dial pad to program the single digit access code. The default access code is 9.

Programming hints

— The External Line access code cannot conflict with:

- the Park prefix
- the Direct-dial digit
- the first digit of a Line Pool access code
- the first digit of a DN

If DN length is changed, and the changed DNs conflict with the External Line access code, the setting changes to None.

Digits assigned by default to Configuration settings

Digit	Use	Heading
0	Direct-dial #	4. Miscellaneous
1	Park prefix	3. Call handling
2	the first digit of B1DNs	5. System Data
3	the first digit of B1DNs in an expanded system	5. System Data
9	External Line access code	4. Miscellaneous
-	-	-
	Line Pool access code (Not assigned by default, but takes precedence over the External Line access code if there is a conflict.)	4. Miscellaneous

Line Pool access codes

This setting allows you to assign a Line Pool access code for each of the fifteen line pools (A to 0). These codes are used to specify the line pool you wish to use for making an outgoing external call.

Use the [Show] button, the **CHANGE** display button, the dial pad, and the OK display button to program the access code. The default access code is blank.

Programming hints

- The code can be one to four digits in length. Line Pool access codes starting with the same digit must be the same length.
- A Line Pool access code can be the same as an external line access code. In this case, the Line Pool access code takes priority over the external line access code, and a line from the line pool is selected.
- A Line Pool access code cannot conflict with:
 - the Park prefix
 - the Direct-dial digit
 - the first digit of any Received number
 - the first digit of any DN (including the Auto DN or the DISA DN).
- To avoid a conflict, refer to the table of default settings in the description of External code.

Installer password

This setting allows you to change the Installer password that allows access to Configuration programming.

Use the **CHANGE** display button, the dial pad, and the **OK** display button to program the Installer password.

Programming hints

- You can choose any combination of one to six digits. It is easier to remember the password if the digits spell a word. Provide this password only to selected personnel to prevent unauthorized access to Configuration programming. The implications of such access may include the rearrangement of line assignments, which could affect the operation of the Norstar system.
- The default Installer password is 266344 (CONFIG).

System Data

System Data allows you to specify system-wide settings.

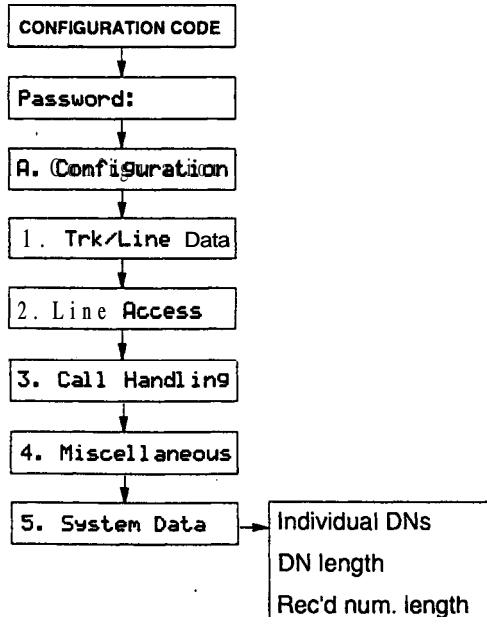

Individual DNs

Individual DNs allows you to change the Directory Number (DN) or internal number of a telephone.

CAUTION

Changing an individual DN locks the Configuration session into the System Data programming mode. When the System Data session ends, re-enter the Configuration access code and the Installer password to continue with other Configuration or General Administration programming.

Do not perform Startup again, or all previous programming will be erased.

Use the [Show] button, the dial pad, and the OK display button to identify the DN you want to change. Then, use the dial pad, and the OK display button to enter the new DN.

Programming hints

- No DN changes occur until the Configuration session ends.
- If the “new DN” already exists for another telephone, that other telephone is given the “old DN”.

— All DNs must be the same length.

— The first digit of a new DN cannot be the same as the first digit of:

- an External Line access code
- a Line Pool access code
- the Park prefix
- the Direct-dial digit

To avoid a conflict, refer to the table of default settings in the description of External code.

— The lowest default DN for a non-expanded system is 21, and the lowest default DN for an expanded system is 221.

DN length

This feature allows you to change the number of digits for all internal DNs. The maximum length is seven. The default and minimum length is three for an expanded (with Expansion Cartridge) Norstar system, and two for a non-expanded Norstar system.

Use the CHANGE display button to select the setting: 2, 3, 4, 5, 6, or 7 for a non-expanded system; or **3**, 4, 5, 6, or 7 for an expanded system ('2' is not available for an expanded system).

Programming hints

- A non-expanded system (with a default DN length of 2) is automatically changed to a DN length of 3 after an expansion cartridge is installed and power is restored to the KSU.
- If any future expansion is planned, the DN length should be set to three, even on non-expanded systems.
- A DN length change, if required, should be the first programming change on a newly installed Norstar system.
- Each increase in length places the digit 2 in front of any existing DN. For example, if DN 3444 was increased to a length of 6, the new DN would be 223444.
- If the DN length is changed so that a conflict is created with the Park prefix, External Line access code, Direct-dial digit, or any Line Pool access code, the setting for the prefix or code is changed to None, and the corresponding feature is disabled.

CAUTION

You must wait for at least two minutes after a system startup before you change the DN length.

Data devices drop calls when the DN length is changed. (Data devices use the B2 channel. The M7100, M7208, M7310, and M7324 Telephones use the B1 channel. Calls are not dropped for these telephones.)

The DN length change is completed within two minutes, depending on the size of the installed Norstar system. System response may briefly slow down during this time. You cannot re-enter Configuration programming during this time. If you enter the Configuration access code, the message In usc: **SYSTEM** appears on the display.

Received number length

The Received number length setting allows you to change the number of digits received on auto-answer trunks. These digits are used to identify target lines, Auto DNs, and DISADNs. Use the **CHANGE** display button to select the setting: 1, 2, 3, 4, 5, 6, or 7. The default for a non-expanded system is 2. The default for an expanded system is 3. Then, use the button to enter the new Received number length.

Programming hints

- The target line number (for example, line 081) and the Received number for the target line (for example, **Rec' d #: 1234** for line 081) are two different numbers.
- The Received number length may be the same as the system DN length, or may, because of network or CO constraints, be set to some other value.
- A received number may be one to seven digits in length. The default length is three.
- Target lines are supported only on expanded Norstar systems. The **Rec' d #:** prompt does not appear when programming non-expanded Norstar systems.
- Changing the Received number length causes all programmed received digits to be cleared.

Set copy

Set copy allows you to copy programmed data from one telephone to another. You have two choices when deciding which data to copy:

- you can copy System data only;
- you can copy System data and Personal programming data.

System data is programmed in Configuration and Administration. Personal programming data is programmed by people at their own telephones, in order to customize their telephones to their own needs.

Remember:

- Set copy operates only from the **Norstar M7310** or **M7324** Telephones.
- Do not confuse Set copy with the **COPY** display button. **COPY** is more selective than Set copy. It allows you to copy specific groups of data from one telephone to another telephone or from one external line to another external line. You can copy more selective groups of System data listed in the table below by pressing **COPY** when it appears.
- If you are copying both System data and Personal programming data, the source and destination telephones must each be the same **Norstar** model. If you are copying System data only, the telephones can be different **Norstar** models.
- Copying data to a telephone overrides any of that telephone's previous programming.
- Know which data can and cannot be copied. These are shown in the following two charts.

System data

System data which CANNOT be copied		System data which CAN be copied
Alarm Telephone designation	Answer button assignments	Line Pool access
CAP assignment	Automatic Handsfree	Line / Telephone Filter
Direct-dial Telephone #designation	Autolog/Show Vmsg	Number of intercom buttons
Directory Number (DN)	Auxiliary ringer	Paging
Extra-dial Telephone designation	Call Forward No Answer	Page Zone
Log space	Call Forward No Answer Delay	Pickup Group
Service Modes Control Telephone designation for a line	Call Forward On Busy	Prime line designation
Service Modes Ringing Telephone designation for a line	Direct-dial Group	Priority Call permission
Prime Telephone designation for a line	First Display	Redirect Ring
Private line appearances	Full Handsfree	Ringing line preference
Telephone Name	Handsfree Answerback	Telephone Administration Lock
	Hotline	Telephone Filter
	Line assignment	

Personal programming data

Personal programming data which CANNOT be copied	Personal programming data which CAN be copied
Autobump	Dialing modes (Automatic Dial, Pre-Dial, Standard Dial)
Autolog options	Language Choice
CAP module memory button assignments	Line button positions
Contrast Adjustment	Personal Speed Dial entries
Log password	Telephone memory button assignments (Internal Autodial, External Autodial, and feature access)
Ring Type	
Rina Volume	

Applying Set copy

1. Access Configuration programming.
The display shows **A. Configuration**.
2. Press twice.
The display shows **C. Set COPY**.
3. Press [Show].
4. If you want to copy System data only, go to step 5.
OR
If you want to copy both System data and Personal programming data, press **CHANGE**.
5. Press _(Next].
6. Enter the internal number of the telephone from which you want to copy data.
7. Enter the internal number of the telephone to which you wish to copy data.
8. If you wish to copy the same data to another telephone, repeat step 7.
OR
To return to **C. Set COPY**, press .
OR
To end the session, press .

Maintenance

A Maintenance session is a Norstar software feature that helps you quickly diagnose problems that may occasionally arise within the Norstar system.

A Maintenance session has six headings.

D. Maintenance



1. System Version



2. Port/DN Status



3. Module Status



4. Diagnostics



5. Sys Test Log



6. Sys Admin Log

System Version displays the version numbers of the two processors in your Norstar system.

Port/DN Status allows you to check and change the status of ports in your system.

Module Status allows you to check and change the status of modules in your system.

Diagnostics allows you to run a diagnostic test on ports in your system.

System Test Log displays a list of diagnostic test results, audits, event messages and alarm codes.

System Administration Log displays a list of system initializations, Configuration sessions, invalid password attempts and password changes.

You may run a Maintenance session from any working Norstar M7310 or M7324 Telephone. Only one person at a time can access a Maintenance session. Keep a pencil handy to record important information on photocopies of the Maintenance records. The Maintenance records are found at the end of this chapter.

Beginning a Maintenance session

1. Release all calls on your telephone.
2. Enter the Configuration access code:

Feature * * C O N F I G

which is the same as

(Feature) * * 2 6 6 3 4 4

The display shows Password:

3. Enter the Installer password (the password does not appear on the display as you enter it). The default Password is **CONFIG** (266344).

If the password is correct, the display shows

A. Configuration, and three triangular indicators ► appear on the vertical display between the rows of buttons.

If the password is incorrect, the display does not change. Check the password. Press RETRY and re-enter the password.

4. Place the *Norstar Programming Overlay* over the buttons pointed to by the indicators ►.
5. Press (Next) three times until the display shows **D. Maintenance**.

System Version

System Version allows you to note the version numbers of the software in the two processors in your Norstar system:

- | System Processor (SP) software, residing in the Feature Cartridge, and
- | Real Time Processor (RTP) software, residing in the Key Service Unit (KSU).

Version numbers can be used to determine whether you have the latest software release, and to trace a software fault if one occurs. For instance:

- | SP and RTP version numbers can indicate a Software Cartridge incompatibility.
- Trunk Cartridge and RTP version numbers can indicate a Trunk Cartridge incompatibility.
- | SP and telephone version numbers can indicate a telephone version incompatibility.
- | SP and functional terminal version numbers can indicate a functional terminal incompatibility.

162 / System Version

To check the version number, start with the display showing

D. Maintenance:

1. Press **[Show]**.
The display shows **1. System** Version.
2. Press **Show** .
The display shows the version number of the SP.
3. Write the SP version number on the appropriate Maintenance record.
4. Press **RTP**.
The display shows the version number of the RTP.
5. Write the RTP version number on the appropriate Maintenance record.
6. Press **Heading** .
The display returns to **1. System** Version.

Port/DN Status

Port/DN Status allows you to:

- | identify any device or line connected to the system,
- check the version number of a device (an Analog Terminal Adapter, for example) for compatibility with the system,
- check the state of a device or line (for example, idle or busy), and
- | disable or enable a device or line.

You can use Port/DN Status to:

- | determine which port number corresponds to each DN,
- | determine the port number of a malfunctioning device,
- | determine if a malfunctioning device is incompatible with the Norstar system,
- | disable a device before replacing it. This generates Norstar telephone display messages informing device users of what you are doing, and
- clear a hung line by disabling and enabling a line port.

Remember

You cannot disable the Norstar telephone from which you are accessing the Maintenance session. If you try to do this, a message appears on the display and you hear an error tone. Therefore, if you wish to disable that particular telephone, you will have to conduct the Maintenance session from another Norstar telephone.

CAUTION

You should not disable devices or lines when many people are using the Norstar system. Wait until after regular office hours.

Do not enable or disable ports at the following times:

- during the first two minutes after a System Startup, and
- before DS-30 cables are connected.

If you do so, incorrect ports may be enabled or disabled. To recover from this, disable then enable the affected modules using Module Status.

Examining Port/DN Status

Note: Port/DN Status allows you to check lines and devices on the system. Although the following procedures describe how to check devices, you can use the same procedures to check lines.

Identifying any device connected to the system

Start with the display showing 1. **System Version:**

1. Press .
The display shows 2. **Port/DN Status.**
2. Press [Show].
The display shows Show **port: _.**
3. On the dial pad, enter the port number of the device.
OR
Press DN, then enter the directory number of the device.
Device information appears (see the sample device identification display in the figure on the following page). This identifies the device connected to the BI channel.
4. If there is an add-on device attached to a **Norstar** telephone such as a Central Answering Position (CAP) module or a Busy Lamp Field (BLF):
Press to view the add-on devices.
OR
If you want to identify the device connected to the **B2** channel:
Press >B2.
5. Press twice to return to the display
2. **Port/DN Status.**

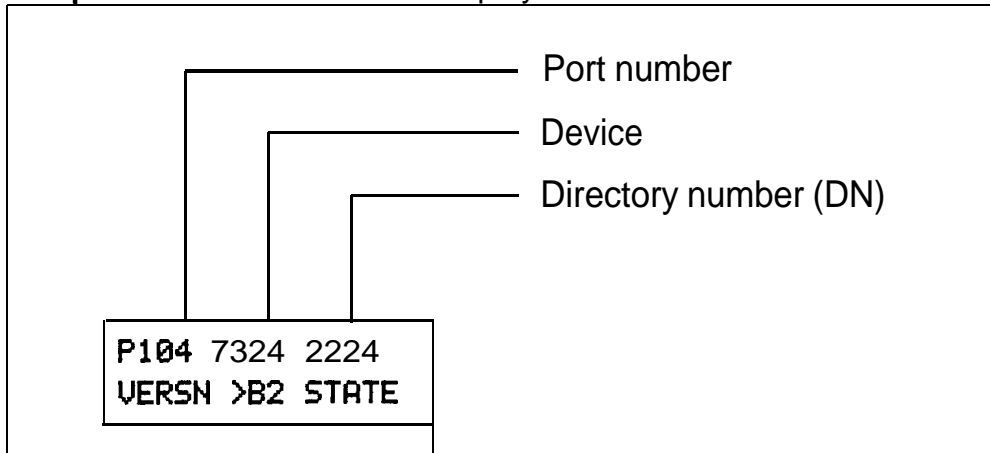
Sample device identification display

Note: This sample display associates DN 2224 with port 104.

The following table lists some of the device types that may appear on the Norstar device identification display.

Explanation of device type

Display	Explanation
7100	M7100 Telephone
7208	M7208 Telephone
7310	M7310 Telephone
7324	M7324 Telephone
1:MODULE1	First add-on CAP module attached to an M7324
2:MODULE2	Second add-on CAP module attached to an M7324
ATA	Analog Terminal Adapter
BLF	Busy Lamp Field
CII	Call Identification Interface

Checking the version number of the device

From the Norstar device identification display:

1. Press VERSN (if it is available).
The display shows the version number of the device.
OR
The display briefly shows Not available, and then the previous display re-appears. In this case, you cannot record the version number.
2. If the display showed a device version number, write down this number on the appropriate Maintenance record.

To return to the Norstar device identification display from the display showing the version number:

1. If you want to retain the same port number:
Press OK.
OR
If you want to see information about the next higher port number (or DN if that is how you entered):
Press [Next].
OR
If you want to see information about the next lower port number (or DN if that is how you entered):
Press .

Checking the state of the device

From the Norstar device identification display:

1. Press STATE.
The display shows one of the states listed in the table on the following page.
2. If you want, you can disable or enable the device (see the procedures in this chapter).
OR
If you want to return to the device identification display, press OK.

How the device state is shown on the display

Display	State of device
<pre> Busy DISABLE OK </pre>	The device is in use.
<pre> Disabling... OK </pre>	The device is being disabled.
<pre> Enabling... OK </pre>	The device is being enabled.
<pre> Idle DISABLE OK </pre>	The device is not in use.
<pre> Waiting for idle DISABLE OK </pre>	The device will be disabled as soon as it becomes idle.
<pre> Unequipped DISABLE OK </pre>	There is no device connected to that port.
<pre> Disabled by user ENABLE OK </pre>	The device has been disabled by someone running a Maintenance session.
<pre> Disabled by sys. ENABLE OK </pre>	The device has been disabled by the system because it is faulty or because a test is running.
<pre> Not available DISABLE OK </pre>	There is no state available.

Disabling the device when it becomes idle

When the display shows you that the device is busy:

1. Press **DISABLE**.

The display shows Disabl **e** at **idl e**?

2. Press **YES**.

The device is disabled immediately after the user hangs up.

Note: If you disable a line on a Trunk Cartridge, the remaining three lines on that Trunk Cartridge are also disabled.

Note: If you choose the Disabl **e** at **idl e**? option, but the device remains in use, you can disable the device immediately.

Disabling the device immediately

CAUTION

Make sure you inform people that you are going to disable their devices (or lines).

A device becomes disabled one minute after you press **YES** from Disable at **once**? The next two tables show examples of the sequence of messages that might appear on a telephone that you are disabling.

Examples of display messages

Disabling a line		Disabling a device
		Before disabling
Please hang up testing line 016	twice	Please hang up Maintenance test
45 seconds until disconnect.		45 seconds until disconnect.
Please hang up		Please hang up
		After disabling
Not in service		In maintenance

To disable immediately when the display shows you that the device is busy:

1. Press **DISABLE**.
The display shows Disable at **idle**?
2. Press **CHANGE**.
The display changes to Disable at once?
3. Press **YES**.

The device prompts its user (described previously) and is disabled in one minute (or immediately, if the device is idle).

Enabling the device

When the display shows you that the device is disabled:

1. Press **ENABLE**.

The display briefly shows **Enabl ing...** The device is immediately enabled and the display shows **Idle**.

Note: The display may briefly show **Enabl ins., . .**, then either **Disabled by sys.** or **Disabled by user**. In this case, the system is waiting to disable the module. This may occur after someone has run a Maintenance session and used either Module Status or Diagnostics. You cannot enable the device until its module has been disabled.

Returning to the beginning

From the display showing the state of the device:

1. Press **OK**.
2. Press **[Heading]**.
3. Press **[Heading]** again.
The display shows 2. **Port/DN Status**.

Module Status

Module Status allows you to:

- look at the inventory of Station Modules (SMs), Trunk Modules (TMs), and modules inside the Key Service Unit (KSU),
- check the number of Trunk Cartridges (TCs) attached to each Trunk Module,
- check the state of the module or its cartridges, and
- disable or enable the module or its cartridges.

You may use Module Status to:

- isolate any malfunctioning modules, and
- disable a module before replacing it.

Module numbering schemes for Two-port and Six-port Expansion Cartridges

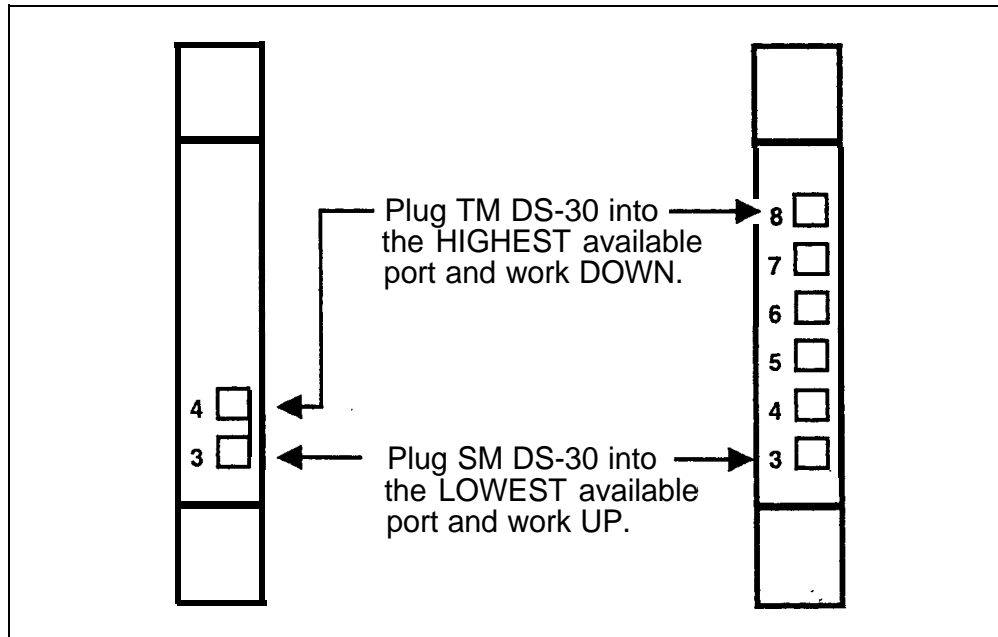

Note: Modules 1 and 2 are located inside the KSU.

Examining **Module Status**

Looking at the module inventory

Start with the display showing 2. **Port/DN Status**:

1. Press .
The display shows 3. **Module Status**.
2. Press **[Show]**.
The display shows **Show** module: **_**.
3. Enter the module number. Modules 1 and 2 are located inside the KSU. Refer to the figures on the previous page for the module numbering scheme.

OR

If you want to check the first module, press **[Show]**.

The display that you see is called the module inventory display.

If you choose module 1 or 2, the display shows how many telephones or lines are connected to the KSU.

If you are checking a Trunk or Station Module, the display shows either how many Trunk Cartridges are connected to the Trunk Module or how many devices are connected to the Station Module.

Note: Norstar devices may occupy both the **B1** and **B2** channels. This may increase the number of devices indicated on the module inventory display.

Checking the number of Trunk Cartridges attached to a TM

Start from the module inventory display, which shows the number of Trunk Cartridges connected to the module you chose (for example, 3 TCs on TM 4).

1. Press **TC**.

If there is no Trunk Cartridge in a slot, the display shows that zero lines are connected. If there is a Trunk Cartridge in a slot, the display shows that four lines are connected (for example, 4 lines on TC 1).

Note: If there is no Trunk Cartridge in slot number one (the left-most slot), the display shows that the module is empty.

2. If you want to check for Trunk Cartridges in the other two slots:
Press **[Next]** or .
3. Press **MODULE** to return to the module inventory display.

Checking the state of a TM

Start from the module inventory display, which shows the number of Trunk Cartridges connected to the module you chose (for example, 3 TCs on TM 4).

1. Press **STATE**.

The state of the module is shown on the display. Some examples of this display are shown on the following page.

2. If you want, you can disable or enable the module. (See the procedures in this chapter.)

OR

If you want to return to the module inventory display:
Press **OK**.

 How the module or cartridge state is shown on the display

Example display	State of module or cartridge
<pre>3 sets busy DISABLE OK</pre>	There are three devices in use that are connected to the module or cartridge.
<pre>2 ports busy DISABLE OK</pre>	There are two ports in use that are connected to the module or cartridge.
<pre>4 lines busy DISABLE OK</pre>	There are four lines in use that are connected to the module or cartridge.
<pre>Disabling... OK</pre>	The module or cartridge is being disabled.
<pre>Enabling... OK</pre>	The module or cartridge is being enabled.
<pre>Waiting for idle DISABLE OK</pre>	The module or cartridge will be disabled as soon as it becomes idle.
<pre>Unequipped DISABLE OK</pre>	There is no module or cartridge connected to that DS-30 port.
<pre>Disabled by user ENABLE OK</pre>	The module or cartridge has been disabled from a Maintenance session.
<pre>Disabled by sys. ENABLE OK</pre>	The module or cartridge has been disabled by the system because it is faulty or because there is a test running.

Checking the state of a cartridge

Start from the display that shows the number of lines connected to the Trunk Cartridge you chose (for example, 4 **l**ines on TC 1).

1. Press **STATE**.

The state of the cartridge is shown on the display. Some examples of this display are shown on the previous page.

2. To check the state of a Trunk Cartridge present in, one of the other two slots:

Press or [Back).

3. Disable or enable the cartridge. (See the procedures in the following two sections.)

OR

To return to the display showing how many lines are connected to the Trunk Cartridge:

Press **OK**.

Disabling the module or its cartridges

CAUTION

Use the Page feature to inform people using Norstar that you are about to disable a module. Mention that they may experience delays in the performance of their devices.

From the display showing the state of the module or cartridge:

1. Press, **DISABLE**.
2. If the module or cartridge is not idle and you want to disable it when it becomes idle:
Press **YES**.
OR
To disable the module or cartridge immediately:
Press **CHANGE**, then press **YES**.

Enabling **the** module or its cartridges

From the display showing the state of the module or cartridge:

1. Press ENABLE.

The display briefly shows *Enabl ins. . . .* The module or cartridge is immediately enabled. The display then shows the state of the module or cartridge.

Returning to the beginning

From any display showing the state of the module or cartridge:

1. Press OK.
2. Press [Heading] twice.

The display shows 3. Module Status.

Diagnostics

Diagnostics allows you to:

- | select the connectivity test (test #100),
- identify which ports you wish to test,
- begin the test, and
- check the test results.

If you suspect that a voice connection may be broken, you can use Diagnostics to run the connectivity test. This test runs in three stages, stopping when any stage fails.

Stage 1 initializes any apparently empty ports and runs a sanity test to any device on that port.

Stage 2 disables the specified port and runs a write and read test.

Stage 3 disables both modules associated with the specified port and runs a write and read test.

Remember

Do not run the connectivity test:

- | while ports or modules are being disabled, or
- | during the first two minutes after a System Startup.

If you do so, the test may stop running with ports still disabled. To recover from this, power down, then power up the KSU.

CAUTION

The connectivity test may disrupt service as modules are disabled. Do not run this test when many people are using the Norstar system.

Running Diagnostics

Selecting the connectivity test

If you want to run the connectivity test while others are using the Norstar system, you should first inform them using the Page feature. Mention that they may experience delays in the performance of their devices.

Start with the display showing 3. **Module** Status:

1. Press .
The display shows 4. **Diagnostics**.
2. Press [Show].
The display shows **Enter test#: --**.
3. Enter from the dial pad.
The display shows **Test port: --**.

Identifying which ports you want to test

You can perform the connectivity test on a maximum of 16 ports.

Start with the display showing **Test port: -:**

1. Enter all the port numbers from the dial pad, pressing **OK** after each entry.
2. Press .
The display shows you how many modules may be disabled when you run the test. The display then changes to **Begin test 100?**

Beginning the connectivity test

Start with the display showing **Begin test 100?:**

1. Press **YES**.
The display shows **Display results?**

Checking the test results

Start with the display showing **Display results?**

If you want to see the test results from the display:

1. Press YES.
The display shows **Running test 188**.
When the test is finished, the display shows the test results, for example, **P110100-04**. In this case, port number 110 was the first port tested, and "04" is the result code of test 100. The result codes are explained in the table on the next page.
2. Press MORE if it appears as a display button. The test results for the next port number are shown.
3. Repeat step 2, if applicable.
4. Press EXIT.
You are returned to the display showing **4 . Diagnostics**.

Note: If your Norstar telephone is connected to the module you test, it will be disabled. Run a new Maintenance session to see the results.

If you do not want to see the test results from the display:

1. Press NO.
The display briefly shows:
For results see
Sys. Test Log

Connectivity test results

Result code	Test results
00	You entered an invalid port number.
01	Stage 1 passed: The KSU device port is receiving signals properly. If the device has no voice connection, the problem is with the device.
02	Stage 1 passed: The KSU trunk port is receiving signals properly. If the trunk has no voice connection, the problem is likely with the external line, the 25-pair cable or the cross-connect.
03	Stage 1 passed: The Trunk Cartridge is receiving signals properly. If the trunk has no voice connection, the problem is likely with the TC, the external line, the 25-pair cable, or the cross-connect.
04	Stage 1 failed: There is no signaling to this KSU-based device, but other devices on the KSU work. The problem is likely with the TCM line, the device, the 25-pair cable to the KSU, or the cross-connect.
05	Stage 1 failed: There is no signaling to this SM-based device, but other devices on this SM work. The problem is likely in the TCM line, the device, the 25-pair cable to the SM, the cross-connect, or the SM.
06	Stage 1 failed: There is no signaling to any KSU-based device. The problem is likely with the 25-pair cable to the KSU or with the cross-connect.
07	Stage 1 failed: There is no signaling to any device on this Norstar bus. The problem is likely with the 25-pair cable to the module, the module, the DS-30 cable, or the Expansion Cartridge.
08	Stage 3 failed: A KSU-based fault was detected. Replace the KSU.
09	Stage 3 failed: A fault was detected in the Expansion Cartridge. Replace the Expansion Cartridge.

System Test Log

The System Test Log shows you a list of diagnostic test results, audits, event messages, and alarm codes. By using this feature you can:

- check the items in the log,
- check the current alarm (if there is one),
- check when each item in the log occurred,
- check the number of consecutive occurrences of an event or an alarm, and
- erase the log.

Note: The System Test Log holds a maximum of 20 items. You should check and record these items at regular intervals. Erase the log after dealing with all the items.

Examining the System Test Log

Checking the items in the log

Start with the display showing 4. Diagnostics:

1. Press .
The display shows **5.Sys Test Los.**
2. Press **[Show]**.
The display shows **Start of new l 09** or **Start of 109.**
3. Press or .
4. Write down the item on the System Test Log record.
5. If the log item is an event message or an alarm code, refer to the Event messages section or the Alarm codes section in this chapter.
6. Repeat steps 3, 4, and 5 until you have recorded all the items.

Checking the current alarm

If you want to quickly check the highest severity alarm before viewing all the log items, start with the display showing **Start of new log** or **Start of log**:

1. Press **ALARM**.

The display shows an alarm code if there is a current alarm.

2. Press **EXIT** to return to the display **Start of log**.

OR

The display shows **No current alarm** and then shows **Start of new log** or **Start of log**.

Note: All alarms are recorded as items in the System Test Log.

Checking when each item in the log occurred

Start with any display showing a log item:

1. Press **TIME**.

The display briefly shows the date and time.

2. Write the date and time on the System Test Log record.

Checking the number of consecutive repetitions of an event or alarm

If **REPEAT** appears under a display showing a log item:

1. Press **REPEAT**.

The display shows the number of consecutive times the event or alarm occurred.

Erasing the log

If you want to erase the System Test Log, start with the display showing Start of new **LOG** or Start of **LOG**:

1. Press **ERASE**.

The display shows Erase log?

2. Press **YES**.

If no new items have been added since the list was entered, the log is erased and the display shows Los is **empty**.

OR

If new items have been added since the list was entered, the display shows Los has changed.

3. If the display shows Los has changed:

To show the new log, press **[Show]**.

OR

To return to **5.Sys** Test Los, press **EXIT**.

System Administration Log

The System Administration Log keeps a record of administrative events such as system initializations, Configuration sessions in which a change was made, invalid password attempts, and password changes. By using this feature you can:

- check the items in the log,
- erase the log, and
- check when each item in the log occurred.

Note: The System Administration Log holds a maximum of ten items. Erase the log after dealing with all the items.

Examining the System Administration Log

Checking the items in the log

Start with the display showing 5 **Sys Test Log**:

1. Press **[Next]**.
The display shows 6. **Sys Admin Los**.
2. Press **Show**.
The display shows **Start** of new 1 **og** or
Start of 109.
3. Press **[Next]** or **Back**.
The display shows a log item.
4. Write down the item on the System Administration Log record.
5. Repeat steps 3 and 4 until you have recorded all the items.

Checking the current alarm

Start with the display showing **Start of new log** or **Start of log**:

1. Press **ALARM**.
The display shows an alarm code if there is a current alarm.
2. To return to the display showing **Start of log**:
Press **EXIT**
O R - -
The display shows **NO current alarm** and then shows **Start of log**.

Erasing the log

if you want to erase the System Administration Log, start with the display showing **Start of log**:

1. Press **ERASE**.
The display shows **Erase log?**.
2. Press **YES**.
If no new items have been added since the list was entered,
The display shows **Log is empty**.
OR
If new items have been added since the list was entered, the
display shows **Log has changed**.
3. If the display shows **Log has changed**, to show the new log,
press **[Show]**.
OR
To return to **6. Sys Admin Log**, press **EXIT**.

Checking when each item in the log occurred

Start with any display showing a log item:

1. Press **TIME**.
The display shows the date and time.
2. Write down the date and time on the System Administration Log record.

Alarm codes

The Norstar KSU generates alarm codes after system disconnections or after certain anomalies in system operation. All alarm codes appear at the Alarm Telephone and in the System Test Log of a Maintenance session. The following figure shows an alarm code appearing on a Norstar Alarm Telephone display.

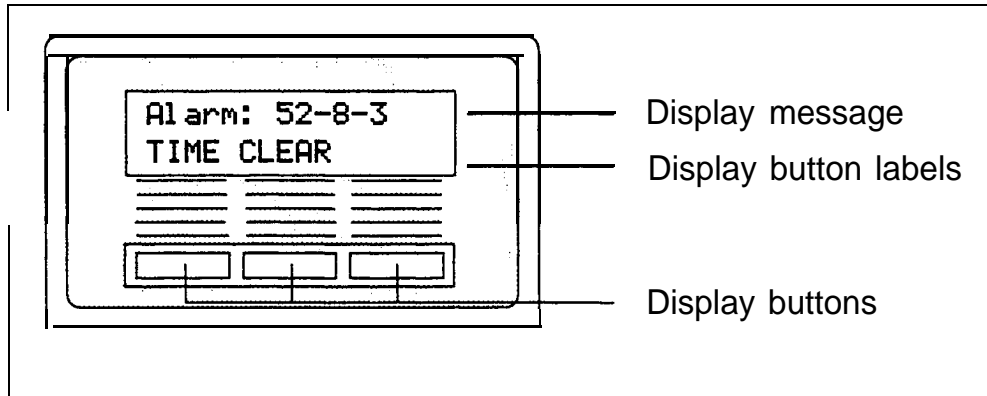

Note: Alarms have a higher severity than events. Attend to alarm codes before event messages.

If you see an alarm code

1. Write the alarm code on the System Test Log record.
2. Determine the cause of the alarm from the following table.
3. Follow Alarm troubleshooting procedures in this chapter.
4. Press TIME to see when the alarm occurred.
5. Press CLEAR to clear the alarm.

An alarm code may not be displayed until two minutes after it has been triggered. If the KSU is powered OFF when the alarm is triggered, the alarm code is not displayed until two minutes after the KSU is powered ON.

 Causes of alarm codes

Example display	Meaning	Possible causes
A1 arm: 10	All KSU devices disconnected.	<p>The last device on Norstar bus 1 (port numbers 101-124) has been removed.</p> <p>The 25-pair cable was disconnected from the KSU.</p> <p>There is an internal KSU fault.</p>
A1 arm: 11	Internal KSU failure.	The KSU is defective.
A1 arm: 50-X	All devices on SM disconnected.	<p>The last device on Norstar bus X (port numbers X01-X16) has been removed.</p> <p>The 25-pair cable was disconnected from the SM.</p> <p>The DS-30 cable from the SM to the KSU has been disconnected.</p> <p>The SM was powered down.</p>
A1 arm: 51-X	Trunk Module disconnected.	<p>All Trunk Cartridges have been disconnected from the TM on DS-30 port X.</p> <p>The TM was powered down.</p> <p>The DS-30 cable from the TM to the KSU has been disconnected.</p>
A1 arm: 52-X-V	TC disconnected from TM	Trunk Cartridge Y on DS-30 port X has been disconnected from the TM.

"X" = DS-30 port number (1-8)

"Y" = Trunk Cartridge number (numbered from left to right)

Causes of alarm codes (continued)

Example display	Meaning	Possible causes
Al arm: 61-X-V	Incompatible Trunk Cartridge	Trunk Cartridge Y on DS-30 port X cannot operate with the Trunk type assigned to it in Configuration.
Al arm: 62-V-Z	Unsupported Auto-answer setting (loop start TCs)	Trunk Cartridge Y on Trunk port Z does not support the auto-answer setting.
Al arm: 63 -Z	No available DTMF receivers	DTMF receivers are busy, not working properly, or have not been installed.

"X" = DS-30 port number (1-8)

"Y" = Trunk Cartridge number (numbered from left to right)

"Z" = Trunk port number

Alarm troubleshooting

Note: Refer to the previous table before following these procedures.

Alarm:10

1. Check to see if there is a device connected to the KSU (that has a port number beginning with the number "1 ").
2. If there are no devices connected to the KSU, connect one and then press **CLEAR**.
3. If there are any devices connected to the KSU, check all the wiring associated with the devices.
4. Refer to the section in the Troubleshooting chapter entitled KSU down.

Alarm: 11

1. Power down the KSU and then power it up.
2. If the alarm persists, replace the KSU.

Alarm:50-X

1. Check that there is a device connected to the Station Module (that has a port number beginning with a number from three to eight).
2. If there are no devices connected to the Station Module, connect one and then press **CLEAR**.
3. If there are any devices connected to the Station Module, check all the wiring associated with the devices.
4. Refer to the section in the Troubleshooting chapter entitled Station Module down.

Alarm:51 -X

1. Check the wiring from the KSU to the TM.
2. In the Troubleshooting chapter, follow the procedure for checking the Trunk Cartridge .
3. Refer to the section in the Troubleshooting chapter entitled Trunk Module down.

Alarm:52-X-Y

1. Follow the procedure in the Troubleshooting chapter, in the section entitled Checking the Trunk Cartridge.
2. If the problem persists, replace Trunk Cartridge Y on DS-30 port X. (Refer to the previous table for the definition of "X" and "Y").

Alarm:61-X-Y

1. Check that the proper Trunk Cartridges are inserted in the proper slots of the Trunk Module.
2. Enter Configuration programming and look under the **Trk/LineData** heading. Check that the Trunk type and Trunk mode settings are the same for every loop start line connected to Trunk Cartridge Y.

Alarm:62-Y-Z

1. Check that the proper Trunk Cartridges are inserted in the proper slots of the Trunk Module.
2. Enter Configuration programming and look under the **Trk/Line** Data heading. Check that the Trunk mode and Answer mode settings do not conflict for every line connected to Trunk Cartridge Y. If Trunk mode is set to unsupervised, Answer mode must be set to manual.

Alarm:63-Z

1. Check that you have the required E&M/DISA Trunk Cartridges (one for every two auto-answer loop start lines).
2. Enter Configuration programming and look under the **Trk/Line** Data heading. Check that the Answer mode is correct for all the loop start lines.
3. If the problem persists, an E&M/DISA Trunk Cartridge may be malfunctioning. Replace one E&M/DISA Trunk Cartridge at a time until the problem is resolved.

Event messages

Event messages appear as items in the System Administration Log or the System Test Log of the Maintenance session. Most of these event messages can only be caused by an unusual combination of events, and should rarely occur.

Each event is assigned a severity number. An "S" preceding this number, "S4" for example, may appear in the event message. "S8" is the most severe. If the Log is full, new event messages with a higher severity number replace existing event messages of a lower severity. For this reason, you should check event messages at regular intervals. You can then deal with all messages before they are replaced.

Dealing with event messages

For every event message that you see, do the following:

1. Record the event on the appropriate Maintenance record.
2. Consult the next section entitled Significant event messages.
3. To see if the event caused the **Norstar** system to automatically restart, consult the subsequent section entitled Complete list of event numbers.

Significant event messages

The table on the next page lists event messages that are relevant to Maintenance activities. The time that the message is recorded is also provided.

Event message	The event message is recorded when. . .
Test 100 started	diagnostic test number 100 starts
Test 100 Passed	diagnostic test number 100 has been completed
Test 100 failed	diagnostic test number 100 has been completed
Evt: 220-3546 S4	the System Administration Log has been cleared by the DN (3546 in this case)
Evt: 221-3546 S4	the System Test Log has been cleared by the DN (3546 in this case)
Evt: 222-3546 S5	the DN (3546 in this case) enters the debugging facility that is password protected
Evt: 263-302 S8	the KSU takes the E&M line on port 302 out of service because the far end did not respond to a disconnect signal
Evt: 264-302	the E&M line on port 302 is returned to service after the far end finally responded to a disconnect signal (see Evt: 263)
Evt: 265-302 S7	the E&M line on port 302 did not receive an expected wink signal or delay dial signal from the far end
Evt: 268-07 S8	Dialing filter 07 has lost data due to a fault in the system memory
Evt: 269-3546 S8	the Line/set filter for the DN (3546 in this case) has lost data due to a fault in the system memory
Evt: 299 S1	the system powers up after a power failure
Evt: 400 S9	a System Startup is performed using the dial pad digits
<div style="border: 1px solid black; display: inline-block; padding: 2px;">Feature</div> <div style="display: inline-block; border: 1px solid black; padding: 2px;">*</div> <div style="display: inline-block; border: 1px solid black; padding: 2px;">*</div> <div style="display: inline-block; border: 1px solid black; padding: 2px;">S</div> <div style="display: inline-block; border: 1px solid black; padding: 2px;">T</div> <div style="display: inline-block; border: 1px solid black; padding: 2px;">A</div> <div style="display: inline-block; border: 1px solid black; padding: 2px;">R</div> <div style="display: inline-block; border: 1px solid black; padding: 2px;">T</div> <div style="display: inline-block; border: 1px solid black; padding: 2px;">U</div> <div style="display: inline-block; border: 1px solid black; padding: 2px;">P</div>	

Significant event messages (continued)

Event message	The event message is recorded when.. .
Evt:407 S2	there are no more codes for Speed Dial numbers
Evt:408 S2	there is no more memory for Speed Dial codes
Evt:412-3546 S5	the Installer password has been changed by the DN (3546 in this case)
Evt:413-3546 S3	the Administration password has been changed by the DN (3546 in this case)
Evt:414-3546 S5	an invalid Installer password has been entered by the DN (3546 in this case)
Evt:415-3546 S3	an invalid customer password has been entered by the DN (3546 in this case)
Evt:416-3546 S4	system Configuration is performed using the dial pad digits Feature * * C O N F I G
Evt:417-3546 S2	system Administration is performed using the dial pad digits Feature * * A D M I N
Evt:418 S7	a DN change is successful
Evt:419 S2	the time setting has been changed
Evt:421 S8	a DN change failed
Evt:422-3546 S6	a length change by the DN (3546 in this case) has been requested
Evt:423-3546 S6	an individual DN change has been requested by the DN (3546 in this case)
Evt:822 S8	Alarm code 63 is sent because there are no DTMF receivers for an incoming call

Complete list of event numbers

You should rarely see any event messages that are not described in the section entitled Significant event messages. If you do see one of these event messages, the Norstar system has followed its normal recovery from an unusual combination of system events. Although the problem is not a serious one, repeated occurrences of the event number should be reported to the Central Support Center as soon as possible.

As a result of some events, the Norstar system automatically restarts itself. The table on the next two pages lists all the event numbers and tells you which of these events are associated with Norstar system restarts ("Y"=yes, "N"=no).

Most of these events are recorded in the System Test Log. The few exceptions to this are recorded in the System Administration Log, as indicated.

194 / Event messages

Event Number(s)	System Restart	Event Number(s)	System Restart
101-106	Y	280-283	N
107	N	285-298	Y
108-112	Y	299	N
113	N	400 (Admin log)	Y
114-116	Y	401-403	N
117	N	405-411	N
118-120	Y	412-419 (Adminlog)	N
121-123	N	421-423 (Admin log)	N
124-125	Y	424-425	N
126-129	N	426-430	Y
130	Y	431	N
131-132	N	432	Y
133-134	Y	433	N
135-136	N	600-602	Y
137	Y	603-613	N
138-150	N	614	Y
151	Y	615-629	N
152	N	630	Y
160-164	N	631-646	N
170-173	N	800-802	N
200-211	N	803	Y
220 (Admin log)	N	804-807	N
221-222	N	808	Y
223 (Admin log)	Y	809	N
224	Y	810	Y
225-228	N	811-820	N
229 (Admin log)	Y	823	Y
230-235	N	824-825	N
245-248	N	900	N
250-256	N	940-943	N
260-271	N	950-989	N

Maintenance records

Maintenance records are tables on which you can record information you have obtained while running a Maintenance session.

Before you begin, photocopy the three tables in this section.

Recording information on the Maintenance records

To use the following records, do the following:

1. Write on your photocopied tables information that you obtain while running a Maintenance session.
2. Return the completed tables to your Norstar distributor.

Version number record

The Maintenance session tells you the software versions of the Real Time Processor (RTP), the System Processor (SP), and devices connected to the Norstar system. Use the following table to record these version numbers when you run a Maintenance session. You can check the RTP and SP version numbers under the heading System Version. Device version numbers are found under the heading Port/DN Status.

Version Numbers

1. System Version	2. Port/DN Status
SP:	Device:
RTP:	Device:
	Device:
	Device:
	Device:
	Device:
	Device:
	Device:
	Device:
	Device:
	Device:
	<i>Device:</i>
	<i>Device:</i>

Note; Photocopy this page before recording items in the table.

System Test Log record

You can check under the Sys Test Log heading to find a list of diagnostic test results, audits, event messages, and alarm codes. Use the following table to record these log items when you run a Maintenance session.

System Test Log

5.Sys Test Log

Log item	Time of log item	Number of repetitions
	:	
	.	
	:	
	:	
	.	
	.	
Time and date that log was checked		/ /

Note: Photocopy this page before recording items in the table.

System Administration Log record

You can check under the Sys Admin Log heading to find a list of administrative events performed on Norstar. Use this table to record these log items when you run a Maintenance session.

System Administration Log

6.Sys Admin Log

Log Item	Time of log item	Number of repetitions
	:	
	:	
	:	
	:	
	:	
	:	
	:	
	:	
	:	
	:	
	:	
	:	
	:	
	:	
	:	
	:	
	:	
	:	
	:	
	:	
	:	
	:	
Time and date that log was checked	:	/ /

Note: Photocopy this page before recording items in the table.

Troubleshooting

These troubleshooting procedures allow you to solve many problems in the Norstar system. Follow these procedures before replacing any components.

WARNING

Only qualified personnel are to replace components and service hardware.

Where more than one procedure is given, the procedures represent different options from which you should select just one.

Getting ready

Before you begin troubleshooting, gather all the information that is relevant to your network configuration:

- the Norstar Programming Record,
- records from people who use the network, and
- information about other hardware and non-Norstar features within the public or private network.

Other troubleshooting tools

Remember that you can check many of the system parameters without having to go into a Configuration or Administration session.

- From an M7310 or M7324 Telephone, check line data by entering the feature code for Line profile:
 * * L I N E .
- From an M7310 or M7324 Telephone, check telephone data by entering the feature code for Set profile:
 * * S E T .
- To check the buttons on a particular telephone, use the feature code for Button inquiry: * 0 .

Types of problems

The problems you encounter will likely fall into one of the following categories:

Misunderstanding of a feature

A problem may be reported because a Norstar user is unfamiliar with the operation of a given feature. You may be able to solve the problem simply by demonstrating how to use the feature correctly.

Programming errors

You may encounter problems caused by errors in programming. A feature may have been programmed incorrectly or may not have been programmed at all.

Wiring connections

Wiring problems are caused by loose, unconnected, or incorrectly connected wires. Use the procedures in the section on Checking the hardware as a guide.

Equipment defects

You may encounter problems caused by Norstar equipment defects. See the Problems with equipment section later in this chapter for problems related to the system hardware.

General troubleshooting procedure

1. Diagnose the trouble:
 - Ask the users for information regarding:
 - the types of problems they have experienced ,
 - how frequently the problems have occurred, and
 - how many telephones are affected.
 - Test system features and functions.
 - Use the tests described throughout this chapter.
2. Check how a feature is being used. A problem may have been reported because of a misunderstanding about how a feature works. You should confirm that the person who reported a problem understands the intended use and operation of any feature in question.
3. Check for programming errors. Check that the programming recorded in the Programming Record is correct for the intended operation of the system, and verify that this Configuration and Administration programming has been correctly entered.
4. Check wiring or hardware connections. Check the wiring and hardware connections. Refer to procedures in the next section, Installation check.
5. Run a Maintenance session. If the problem persists, run a Maintenance session as described in the Maintenance chapter of this Installer Guide.
6. Check equipment defects:
 - If hardware is shown to be defective, replace it.
 - If the trouble requires expert advice, follow your company's procedure for obtaining assistance.

Installation check

It is important to establish that both your Norstar system and your hardware are operating normally. To be sure of this, follow the procedures in this chapter.

Testing the **Norstar** system

Verify Norstar system functions and programming options by working through the user cards for Norstar telephones and optional equipment, as described in the following procedures.

Test the **Norstar** telephone operations

1. Make and receive calls.
2. Make notes on any problems.
3. Check calls that have been put on hold.

Check the programmable buttons

Use the following feature code to check what is programmed on the programmable buttons:

Button Inquiry code * 0

Test Line and Telephone programming,

You can use the Line and Telephone profile inquiry features (* * L I N E and * * S E T) to verify the programming applied to a specific line or telephone. Refer to the Programming chapter in this Installer Guide for a description of how the Line and Telephone profile features operate.

Test the optional equipment

1. Follow the procedures in the user cards or installation documentation for the following equipment:
 - Analog Terminal Adapter (ATA)
 - Auxiliary ringer (customer-supplied)
 - Busy Lamp Field (BLF)
 - Central Answering Position (CAP) modules
 - Call Identification Interface (CII)
 - Headset (customer-supplied)
 - Music source (customer-supplied)
 - Paging (customer-supplied)
 - Station Auxiliary Power Supply (SAPS)

Test the **Norstar** system programming features

1. Try out some of the features such as System Speed Dial, Telephone/Line filters, and Class of Service.

Test Automatic Telephone Relocation

1. Check that Telephone Relocation is set to **Y** for yes in the Miscellaneous section of Configuration programming.
2. Move the telephone to another location to verify that a telephone can be re-located without re-wiring or re-programming.

Checking the hardware

WARNING

To avoid electrical shock, do the following:

1. Unplug the power to any module before servicing.
2. Do not remove the covers of a module.
3. Refer to the Installation chapter when re-installing components.

Use the following procedures (in sequence) to check apparent hardware faults.

KSU and module ac power cords

1. Check if the LED on the KSU or module (if included in the installation) is ON.
2. If the LED is OFF, check that the ac power cords for the KSU and module are plugged into the ac Power Bar.

Power Bar ac power cords

1. Check that the ac power cord from the Power Bar is plugged into a working ac outlet.

Note: Two Power Bars are required if there are four or more modules. Make sure that the power cord from the second Power Bar is plugged into the first Power Bar.

Feature Cartridge

CAUTION

Always power down before removing or inserting the Feature Cartridge.

1. Make sure that the Feature Cartridge is firmly seated in its slot.

Expansion Cartridge

CAUTION

Always power down before removing or inserting an Expansion Cartridge.

1. If the installation requires an Expansion Cartridge in the KSU, make sure it is inserted properly.

Note: If power is re-applied when the cartridge has been removed, the system programming returns to default settings.

Trunk Cartridge

CAUTION

Always power down the Trunk Module before removing or inserting a Trunk Cartridge.

1. If the installation requires a Trunk Module, make sure the Trunk Cartridge (TC) is inserted properly.

DS-30 cables

1. Make sure that both ends of the DS-30 cables (if included in the installation) are plugged into the KSU Expansion Cartridge and the module connectors.

50-pin connectors

1. Make sure that the 50-pin connectors for the external lines and for the internal wiring are plugged in and fastened securely. Refer to the chapter on Specifications and wiring charts.

25-pair wiring

1. Make sure that the wires are terminated on the distribution block and connected to the correct pins. See the chapter on Specifications and wiring charts.

Internal wiring

1. Check that the station loop resistance does not exceed 59Ω on 0.5 mm or 24-American wire gauge.
2. If the loop length is greater than 305 m (1000 ft), ensure that the Norstar Station Auxiliary Power Supply (SAPS) is in place and functional. Follow the Norstar Station Auxiliary Power Supply Installation Card for instructions.

Cross-connections

1. Check that both ends of cross-connect wires are attached.

Problems with equipment

Before proceeding, make sure that you have followed the procedures in the Troubleshooting overview and the Installation check sections.

Norstar equipment trouble

This section concerns Norstar system equipment faults. Check first for user problems, then wiring and programming errors before replacing Norstar equipment.

Telephone dead

1. If more than one telephone is affected, refer to the section in this chapter entitled Station Module down.
2. Check for the dial tone.
3. Check the display.
4. If the problem persists, replace the telephone with a known working Norstar telephone of the same type (so that the programming is retained).
5. Check the internal wiring at both the modular jack and the distribution cross-connect.
6. Check the line cord.

Note: A TCM port should have between 15 and 20 V dc across the Tip and Ring when the telephone is disconnected.

Running a Maintenance session to test a dead telephone

1. Run a Maintenance session to ensure that the telephone is not disabled. (See **Port/DN Status** in the Maintenance chapter.)
2. While you are in the Maintenance session, run a connectivity test on the port connected to the telephone. This should be done after business hours to avoid losing calls.
3. Disable the port connected to the telephone using the subheading: **2.Port/DN Status**.
4. Enable the port connected to the telephone using the subheading: **2.Port/DN Status**.

KSU down

- 1 If ac power is present and the LED indicator on the KSU is OFF, replace the KSU. (The location of the LED indicators is described in the Installation chapter.)

Norstar telephone display unreadable

If the trouble is with an M7310 Telephone or an M7324

Telephone:

1. Press **[Feature] * 7**.
2. Press the Up or **DOWN** display button to adjust the display to the desired level.
3. Press the **OK** display button.

If the trouble is with an M7100 Telephone or M7208

Telephone:

1. Press **[Feature] * 7**.
2. Press a number on the dial pad to adjust the display to the desired level.
3. Press **[Hold]**.

If the display is still unreadable:

1. Disable the problem telephone.
2. Replace the problem telephone with a known working one.
3. Enable the working telephone.

Trunk Cartridge trouble

1. Check that the cartridge is properly inserted in the Trunk Module.
2. Run a Maintenance session to ensure that the cartridge is not disabled.
3. While you are in the Maintenance session, run a connectivity test on the appropriate ports.

If the problem persists, follow as many of the next steps as required to solve the problem:

1. If ac power is present and the LED indicator on the Trunk Module is OFF, replace the Trunk Module.
2. Replace the DS-30 cable.
Note: Refer to the Installation chapter for information on replacing components.
3. Replace the Trunk Cartridge.
4. Replace the Expansion Cartridge.
5. Replace the KSU.

Trunk Module down

1. Run a Maintenance session to ensure that the Trunk Module is not disabled. (See the Maintenance chapter.)
2. Disable the module using the Maintenance subheading 3. **Module Status**.
3. Enable the module using the Maintenance subheading 3. **Module Status**.
4. While you are in the Maintenance session, run a connectivity test on the appropriate ports.
5. Check the external line by terminating a single line telephone directly on the distribution block, or equivalent, which connects to the Trunk Module.

If the problem persists, follow only as many of the next steps as required to solve the problem:

1. If ac power is present and the LED indicator on the Trunk Module is OFF, replace the Trunk Module.
2. Replace the DS-30 cable.

Note: Refer to the Installation chapter for information on replacing components.

3. Replace the Trunk Cartridge.
4. Replace the Expansion Cartridge.
5. Replace the KSU.

Station Module down

1. Run a Maintenance session to ensure that the module is not disabled. (See Module Status in the Maintenance chapter.)
2. Disable the Station Module using the subheading **3. Module Status**.
3. Enable the Station Module using the subheading **3. Module Status**.
4. If the Station Module is still down, power down, then power up the KSU.

If the problem persists, follow as many of the next steps as required to solve the problem:

1. If ac power is present and the LED indicator on the Station Module is OFF, replace the Station Module.
2. Replace the DS-30 cable.

Note: Refer to the Installation chapter for information on replacing components.

3. Replace the Expansion Cartridge.
4. Replace the KSU.

Symptoms at the alarm telephone

The following troubleshooting procedures focus on alarm codes specific to network configuration.

Alarm telephone shows **Al arm: 61-X-Y**

Possible problem

You have configured one or more lines as one trunk type, but the Trunk Cartridge in slot Y of Trunk Module X is not that type.

Solution

1. Reconfigure the Trunk type to match the type of Trunk Cartridge that has been installed in slot Y of Trunk Module X.
OR
Install a Trunk Cartridge in slot Y that matches the type of Trunk you have configured.

Alarm telephone shows **Al arm: 62-Y-Z**

Possible problem

You have configured one or more loop start trunks as auto-answer, but the hardware on trunk port Z does not provide disconnect supervision.

Solution

1. Reconfigure your auto-answer loop start trunk or trunks as manual-answer.
OR
If the line number of your auto-answer loop start trunk is 009 or greater, install a loop start Trunk Cartridge with disconnect supervision in slot Y, trunk port Z.
OR
If the line number of your auto-answer loop start trunk is between 001 and 008, install a Version 2 or higher KSU.

Alarm telephone shows Alarm: 63-Z

Possible problem

The trunk of port Z has tried, unsuccessfully, to access a DTMF receiver. You have configured more auto-answer loop start trunks than you have DTMF receivers.

Solution

1. Increase your ratio of E&M/DISA Trunk Cartridges to loop start trunks. The maximum is, one E&M/DISA Trunk Cartridge for every two loop start trunks that you have configured as auto-answer.
2. Make sure that all of your E&M/DISA trunks are configured as E&M or DTMF (whichever applies) so that the system knows the receivers are there.

Possible problem

The DTMF receivers are not working properly.

Solution

1. Check the DTMF receivers on every E&M/DISA Trunk Cartridge.

Problems with lines

The troubleshooting problems listed here focus on trouble with making calls or using lines. Follow the procedures in the Troubleshooting overview and the Installation check sections before proceeding with this section.

Calls cannot be made (but can be received)

1. Press **[Feature] [*] 0**.
2. Press a line button.
3. If an incorrect line number or name appears (or if neither appears) on the Norstar telephone display, check the Configuration settings.
OR
If the correct line number or name appears on the Norstar telephone display, make sure the external lines are properly cross-connected.
4. If Trunk Modules or Trunk Cartridges are installed, refer to Trunk Cartridges and Trunk Module down, in the section on Problems with equipment (earlier in this chapter).
5. Check external lines by attaching a test telephone directly on the distribution block, which connects to the Trunk Module.
6. Ensure that the **25-pair** cable is properly connected to the modules or the KSU.
7. If you still cannot make an external call, perform a Maintenance session to check the external line.

Running a Maintenance session to check the external line

1. Run a Maintenance session to ensure that the line (and the Trunk Cartridge) is not disabled or unequipped. (See Port/DN Status in the Maintenance chapter.)
2. Disable the appropriate ports using the subheading
2. **Port/DN Status**.

Note: For charts showing external line port number defaults, refer to the chapter on Specifications and wiring charts.

3. Enable the appropriate ports using the subheading
2. **Port/DN Status**.
4. If you still cannot make external calls, power down, then power up the KSU. This should be done after business hours to avoid losing calls.

Note: To check the line, contact the telephone company.

Dial tone absent (on external lines)

1. Use Button Inquiry, [Feature] [*][0], to display the number of the external line you are testing.
2. Check for a dial tone by using a test telephone at the connections for the external line on the distribution block.
3. If applicable, make sure that a Trunk Cartridge for the line is properly installed in the Trunk Module.
4. Make sure that the Trunk Module DS-30 cable is properly connected to the Expansion Cartridge on the KSU.
5. Refer to the sections Trunk Cartridges and Trunk Module down, in this chapter.
6. Run a Maintenance session to ensure that the line is not disabled. (See Port/DN Status in the Maintenance chapter.)
7. While you are in the Maintenance session, run a connectivity test on the external line that has no dial tone. This should be done after business hours to avoid losing calls.

Hung lines at a telephone

Line indicators that have been solid for a long time are the only visible indication that lines are hung.

A line that has been redirected using Line Redirection may, under some circumstances, remain busy after a call is over. If this happens, the outgoing line for the redirection also remains busy. You can clear this kind of hung line only at the telephone that was used to redirect the line.

1. Select Button Inquiry (* **Q**) at the telephone that was used to redirect the line.
2. Press the button of the redirected line.
3. Press **SHOW** or .
4. Press **DROP** or **Q** .

Both the redirected line and the outgoing line for the redirection should now be cleared.

For lines that are hung for any other reason you will have to run a Maintenance session.

1. Run a Maintenance session and go to the subheading
2. **Port/DN Status**.
2. If the hung line is on the KSU, disable and enable Module 2.
OR
If the hung line is on a Trunk Cartridge, disable and enable only that Trunk Cartridge.

Follow the procedures in the Troubleshooting overview and the Installation check sections before proceeding.

Auto-answer line rings at a **Norstar** telephone

Possible problem

You configured a loop start trunk as auto-answer but the installed hardware does not support disconnect supervision. (In this case, the symptom would be accompanied by the Alarm 62 code symptom.)

Solution

1. Reconfigure the trunk as manual-answer.

OR

If the line number of your auto-answer loop start trunk is 009 or greater, install a loop start Trunk Cartridge with disconnect supervision in slot Y, trunk port Z.

OR

If the line number of your auto-answer loop start trunk is between 001 and 008, install a Version 2 or higher KSU.

Possible problem

You configured the line as auto-answer and supervised, and then reconfigured the line as unsupervised.

Solution

1. Reconfigure the line as manual-answer.

OR

Reconfigure the line as supervised.

Prime telephone gets misdialed calls

Possible problem

The digits sent by a switch at a Central Office or in the private network did not match any Received number, the Auto DN, or the DISA DN. The call has been routed to the Prime telephone for the incoming trunk.

Solution

1. Verify that the switch is sending the correct number of digits for the Received number length defined in your system.
2. Verify all the digit strings that the switch should be sending.
3. Check that you have defined the corresponding Received number for every target line in your system.
4. Make sure that the published telephone numbers for your network are correct.

selected line shows **Not in service**

Possible problem

You have configured a DTMF line to appear at the telephone.

Solution

1. Reconfigure the line so that it does not appear at any telephone and configure another line to replace it at the telephone.

OR

Reconfigure the line as a different type and install trunk hardware to support the new type of line.

Possible problem

The Norstar system has taken an E&M line out of service because the far end did not respond to a disconnect signal from the Norstar system. The symptom would be accompanied by Event code 263 in the System Test Log.

Solution

1. Check with the operators of the system at the far end and find out if their system is operating.
2. Check that your system hardware is receiving signals properly.
3. Check the trunk between your system and the far end system for a break.

Possible problem

The Norstar system has detected no response on an E&M line from the system at the far end. The symptom will be accompanied by Event code.265 in the System Test Log.

Solution

1. Check with the operators of the system at the far end and get them to troubleshoot their system.

Possible problem

The line has been disabled for maintenance purposes.

Solution

1. Enable the line.

OR

If the line will be out of service for some time, configure another line to replace it on the telephone.

Selected line pool shows NO free lines

Possible problem

If this happens often, there are not enough lines in the line pool to serve the number of line pool users.

Solution

1. If the line pool contains loop start trunks, enter Configuration and move under-used loop start trunks from other line pools into the deficient line pool.

OR

If the line pool contains E&M trunks, order more trunks from the telephone company or private network vendor. Install additional Trunk Cartridges of the appropriate type. In Configuration programming, add the new trunks to the deficient line pool.

Problems with features

In general, when you try to use a Norstar feature and it does not work, test 'your lines first to ensure that other feature codes are working.

Follow the procedures in the Troubleshooting overview and the Installation check sections before proceeding.

Problem descriptions

The following is a list of common feature problems that may occur in a Norstar system.

Autodial button cannot be programmed

1. Refer to the Telephone features chapter.
2. If the display shows **Autodial** full , there is no memory left for **Autodial** buttons.
3. If the display shows **Access** denied, someone may be programming changes. Wait five minutes, then try again to program the buttons.
4. Run a Maintenance session and look at the events shown under **5.Sys Test. Log**.

Remote feature code gets no response

Possible problem

A **Norstar** user has called into another **Norstar** system and is trying to activate a remote feature but gets no response after dialing the feature code. The **Norstar** user may have pressed the Feature button to activate the remote feature.

Solution

1. Make sure that remote callers are dialing the feature code correctly. Only the asterisk (*) character, followed by the feature code, can activate a remote feature.

Dialed number shows Restricted **call**

Possible problem

If this happens often, the Norstar telephone or user has an inappropriate set of dialing restrictions.

Solution

1. In Administration programming, check the Set filter and the Line/set filter for the telephone. Assign restrictions and exceptions that will permit access to the required destinations.

OR

Give the Norstar user a Line Pool access code to a line pool that permits access to the required destinations.

OR

If this happens to a number of people who share a line, check the Line filter. Assign restrictions and exceptions that will permit access to the required destinations.

OR

If the caller used the changed Class of Service, check the User filter for the Class of Service. Make sure that the restrictions and exceptions are appropriate for the user.

Music on Hold/Background Music trouble

Although Music on Hold and Background Music are separate features, they share the same wiring and customer-supplied music source.

1. Ensure that the proper feature access code is turned ON. Adjust the volume using the volume control bar.
2. Use the Button inquiry feature **Q** to verify the feature on a programmable memory button.
3. If there is trouble with Music on Hold, check Call Handling in Configuration.
OR
If there is trouble with Background Music, check Miscellaneous in Configuration.
4. Check the wiring between the music source and the 50-pin connector. Pay special attention to the polarity of the connections. See the wiring charts in the Technical data chapter.
5. Ensure that the music source is turned ON, is operational, and the volume control is set properly.

Note; Any music source with a low-output impedance (for example, less than 3,300 ohms) can be connected. Nominal output level should be less than one volt.

Personal Speed Dial cannot be programmed

1. See the troubleshooting procedure for Autodial buttons cannot be programmed, described earlier in this section.

Network telephone trouble for remote users

Symptoms described in this section are those that appear to a remote caller attempting to use Norstar system resources. The remote caller may be calling from the public network or the private network.

Follow the procedures in the Troubleshooting overview and the Installation check sections before proceeding.

Calling directly to **Norstar**

The following troubleshooting procedures focus on a remote caller trying to reach a Norstar telephone or device.

Dialed number gets **ringback** and the wrong person

Possible problem

The digits sent by a switch at a Central Office or in the private network did not match any Received number, the Auto DN, or the DISA DN. The call has been routed to the Prime telephone for the incoming trunk.

Solution

1. Verify that the switch is sending the correct number of digits for the Received number length defined in your system.
2. Verify all the digit strings that the switch should be sending.
3. Check that you have defined the corresponding Received number for every target line in your system.
4. Make sure that the published telephone numbers for your network are correct.

Dialed number gets stuttered dial tone instead of ringback

Possible problem

The remote caller has tried to reach a Norstar target line, but has reached a trunk with DISA instead. Alternatively, the Norstar system has mapped incoming digits onto the DISA DN.

Solution

1. Verify all the digit strings that the switch should be sending.
2. Check that you have defined a corresponding Received number for every target line in your system.
3. Check that you have defined the correct DISA DN for your system.
4. Make sure that the published telephone numbers for your network are correct.

Dialed number gets dial tone instead of ringback

Possible problem

The remote caller has tried to reach a Norstar target line, but has reached the Norstar system instead. Norstar has mapped the incoming digits onto the Auto DN.

Solution

1. Verify all the digit strings that the switch should be sending.
2. Check that you have defined the corresponding Received number for every target line in your system.
3. Check that you have defined the correct Auto DN for your system.
4. Make sure that the published telephone numbers for your network are correct.

Dialed number gets busy tone

Possible problem

Dialed number does not get through

Possible problem

The digits sent by a switch at a Central Office or in the private network did not match any Received number, the Auto DN, or the DISA DN. There is also no Prime telephone assigned for the incoming trunk. In this case, the caller may hear overflow tone from the Norstar system or a recorded message from the originating switch.

Solution

1. Configure a Prime telephone for every incoming trunk.
2. Verify that the switch is sending the correct number of digits for the Received number length defined in your system.
3. Verify all the digit strings that the switch should be sending.
4. Check that you have defined a Received number for every target line in your system.
5. Make sure that the published telephone numbers for your network are correct.

Possible problem

The Norstar system did not receive some or all of the incoming digits.

Solution

1. Check that the system hardware is receiving signals properly.
2. Verify that the switch is sending the correct number of digits for the Received number length defined in your system.
3. If the switch at the far end is sending pulse signals, make sure they are being sent at the proper rate. (Pulse digits must be 300 ms or more apart for Norstar to receive them.)

Possible problem

If remote callers are having difficulty getting through from the public network, there may be a problem with your DID TC.

Solution

1. Connect a single-line telephone with DTMF tones to a DID trunk input on the DID TC.
2. Use the single-line telephone to enter a Received number that has been programmed for a target line in your system. Listen for ringback.
3. If you do not hear ringback, check that the target line is assigned to a telephone and that there is a Prime telephone assigned for the DID trunk.
4. If you now hear ringback, but you also hear the noise of your unanswered call ringing, check the cross-connections. If all the cross-connections are correct replace the Trunk Cartridge.

Possible problem

If remote callers are having difficulty getting through from the private network, there may be a problem with your E&M TC.

Solution

1. Check the cross-connections for the E&M/DISA TC.
2. If the E&M trunks are connected to another Norstar system, make sure that connections have been made as indicated in the Technical data chapter in this Installer Guide.
3. Use the following table to check for correct voltage on the E&M/DISA leads:

Voltages on E&M leads

Leads	Voltage: active	Voltage: inactive
V_{T-R}	125 mV ac on steady dial tone	0 V ac
V_{T1-R1}	125 mV ac on steady dial tone	0 V ac
V_{E-SG}	0 V dc to -5 V dc	-48 V dc
V_{M-SB}	0 V dc to + 2 V dc	-48 V dc

Calling **Norstar** through **DISA**

A remote caller expects to hear two different kinds of tones when calling a DISA number. A stuttered dial tone indicates that the system is ready for a COS password. Once the password is entered, the dial tone is presented.

Dialed number gets **ringback** instead of stuttered dial tone

Possible problem

The remote caller has dialed a DISA number, but has instead reached a target line, or has been routed to the Prime telephone for the auto-answer trunk. The **Norstar** system has mapped the incoming digits from a switch onto a target line, or has been unable to map the digits anywhere.

Solution

1. Verify that the switch is sending the correct number of digits for the Received number length defined in your system.
2. Verify all the digit strings that the switch should be sending.
3. Check that you have defined the correct DISA DN for your system.
4. Make sure that the published telephone numbers for your network are correct.

Dialed number gets dial tone instead of stuttered dial tone

Possible problem

The remote caller has dialed a DISA number, but has reached the Norstar system instead. The Norstar system has mapped the incoming digits from a switch onto the Auto DN.

Solution

1. Verify that the switch is sending the correct number of digits for the Received number length defined in your system.
2. Verify all the digit strings that the switch should be sending.
3. Check that you have defined the correct DISA DN for your system.
4. Make sure that the DISA DN and Auto DN are different enough to prevent misdialing.
5. Make sure that the published telephone numbers for your network are correct.

COS password gets overflow tone

Possible problem

The remote caller may have entered an invalid password.

Solution

1. Check the Administration programming under COS passwords and verify that the caller has a valid password.

Note: Make sure that all users are informed of password changes.

Possible problem

The remote caller may have entered an asterisk (*) as one of the 6 digits.

Solution

1. Instruct remote callers to enter their COS password correctly: enter 6 digits that are numeric characters.

Possible problem

The remote caller may have entered a number sign (#) as one of the 6 digits.

Solution

1. Instruct remote callers to enter their COS password correctly: enter 6 digits that are numeric characters. The number sign (#) may be entered after the 6th digit, but is not required.

Possible problem

The remote caller may have waited more than 15 seconds between entering digits.

Solution

1. Instruct remote callers to enter their COS password correctly: enter 6 digits that are numeric characters. and do not pause too long between digits

Possible problem

The caller may be dialing from a rotary-dial telephone or from a push-button telephone that has the dial-mode set to "pulse".

Solution

1. Inform remote callers that they must dial from a push-button telephone that has the dial-mode set to "tone".

Using **Norstar** remote features

The following troubleshooting procedures focus on a remote caller who has received dial tone for the Norstar system but then encounters a problem when trying to enter the remote feature code.

Dialed feature code gets overflow tone

Possible problem

The remote caller does not have access to that feature.

Solution

1. If the call came in on a trunk with DISA, check the Class of Service that is associated with the remote caller's COS password. If it is too restrictive, assign another COS password that is more suitable.
2. If the call came in on a trunk without DISA, check the Class of Service that you assigned to the incoming trunk. Make sure that it gives the appropriate access to the remote caller.

Possible problem

The feature code is not valid.

Solution

1. Make sure that remote callers have a correct listing of the features that are programmed for remote access.
2. Ensure that remote callers are dialing the feature code correctly. Press **Q** , followed by the feature code to activate a remote feature.

Possible problem

The caller may be dialing on a rotary-dial telephone or on a push-button telephone that has the dial-mode set to "pulse".

Solution

1. Inform remote callers that they must dial from a push-button telephone that has the dial-mode set to "tone".

Dialed feature code gets busy tone

Possible problem

A resource that the remote feature uses may currently be in use. For example, a remote caller trying to use the paging feature would get a busy tone if the auxiliary speaker were being used at the time.

Solution

1. If repeated attempts to use the remote feature get busy tone, there may be a malfunction in a resource that the feature uses. Check that the remote feature hardware is functioning normally.

Calling through **Norstar** to another system

The following troubleshooting procedures focus on a remote caller trying to use your **Norstar** trunks to reach another system.

Line Pool access code gets overflow tone

Possible problem

If the published Line Pool access code is valid, the remote caller does not have access to that line pool.

Solution

1. If the incoming trunk answers with DISA, give the remote caller a COS password that permits access to that line pool.
OR
change the Class of Service for the incoming trunk so that it permits access to that line pool.
OR
give the remote caller a Line Pool access code that is permitted within the Class of Service on the incoming trunk.

Possible problem

If the published Line Pool access code is invalid, the system has attempted, without success, to match the invalid code to a Norstar target line DN, and there is no Prime telephone for the auto-answer trunk.

Solution

1. Make sure that the published Line Pool access codes are correct.
2. Check that the Line Pool access codes have been entered correctly under 4. **Miscellaneous** in Configuration programming.

Possible problem

The caller may be dialing from the network on a rotary-dial telephone or on a push-button telephone that has the dial-mode set to "pulse".

Solution

1. Inform remote callers in the public network that they must dial from a push-button telephone that has the dial-mode set to "tone".

Line Pool access code gets **ringback**

Possible problem

The published Line Pool access code is invalid, and the system has routed the call to the Prime telephone for the incoming trunk.

Solution

1. Make sure that the published Line Pool access codes are correct.
2. Check that the Line Pool codes have been entered correctly under 4. **Miscellaneous** in Configuration programming.

Line pool access code gets busy tone

Possible problem

There are not enough lines in the line pool to serve the number of users.

Solution

1. If the line pool contains loop start trunks, enter Configuration and move under-used loop start trunks from other line pools into the deficient line pool.

OR

If the line pool contains E&M trunks, order more trunks from the telephone company or private network vendor. Install additional E&M Trunk Cartridges. In Configuration programming, add the new trunks to the deficient line pool.

OR

Create a separate line pool for remote users only.

Possible problem

There are DID lines in the line pool.

Solution

1. In Configuration programming, make sure that there are no DID lines in any of the line pools.

Dialed number gets no response

Possible problem

The remote caller, after accessing a line in a line pool, may have started dialing before the far end was ready to receive digits.

Solution

1. instruct remote callers to wait until they hear feedback before entering any digits.

Possible problem

There may be a malfunction in the line that the remote caller accessed.

Solution

1. If the problem is persistent, check that all lines in the affected line pool are functioning normally.

Possible problem

There may be a malfunction in the system that the caller is trying to reach.

Solution

1. Inform the operators of the system at the far end that the dialed number is not getting through.

Problems with optional equipment

Analog Terminal Adapter (**ATA**)

1. Check the single line telephone by using a known working test Norstar telephone.
2. Check the connections to the jack.
3. Check the connections to the ATA.
4. Disconnect the ATA and replace it with a working Norstar telephone. If the telephone still works properly, the KSU and/or the SM are operating properly.
5. Verify that the programming has been done as described in the *Norstar Modular DR5 Programming Record* and the *Norstar Analog Terminal Adapter Installation Card*.
6. If the trouble seems to be in the KSU or SM, double-check all wiring and programming options. If this does not help, refer to the sections on KSU down or Station Module down.

OR

If the trouble seems to be with the ATA, disable the ATA and replace it with a known working one.

Running a Maintenance session to test an **ATA**

1. Run a Maintenance session to ensure that the ATA is not disabled. (See *Port/DN Status* in the Maintenance chapter.)
2. While you are in the Maintenance session, run a connectivity test on the port connected to the telephone. This should be done after business hours to avoid losing calls.
3. Disable the port connected to the ATA using the subheading:
2. *Port/DN Status*.
4. Enable the port connected to the ATA using the subheading:
2. *Port/DN Status*.

Auxiliary ringer

1. If the auxiliary ringer is used for Service Modes (Night, Evening, or Lunch service), ensure that Service Modes is activated from the Control Telephone.
2. Check the wiring between the auxiliary ringer generator and the ringing device. Refer to the auxiliary ringer wiring chart.
3. Check the wiring between the auxiliary ringer generator and the distribution block:

Auxiliary ringer wiring

Feature	Pin
Auxiliary ring (Make)	43 (Yellow-Green)
Auxiliary ring (Common)	18 (Green-Yellow)

4. Ensure that the auxiliary ringer contacts are operating properly by checking for contact operation with an ohmmeter across the auxiliary ringer pin contacts listed above.
5. Check that the auxiliary ringer pin contacts are programmed to operate in conjunction with any or all of the features in the auxiliary ringer programming chart.

Auxiliary ringer programming

Feature	Programmed in	
Auxiliary ringer: Lines	Configuration:	Line Data
Auxiliary ringer: Sets	Administration:	Telephone abilities
Service Modes (Night, Evening, Lunch)	Administration:	Service Modes

Note: The current capacity of the Norstar relay contacts is 50 mA dc. They are designed to operate with the auxiliary ringer generator, or equivalent.

Call Identification Interface

1. Use the Call Information feature on an incoming call to verify the operation of the CII.
2. Check the connections to the CII. Refer to the *CII Installer Card* for installation details.
3. Verify that the programming has been done as described in the *Norstar Modular DR5 Programming Record* and the *Norstar Modular DR5 System Coordinator Guide*.
4. Run a Maintenance session to test the CII.
5. Verify that you are subscribing to visual Call Display services from your local telephone company.
6. Replace the CII

Running a Maintenance session to test a CII

1. Run a Maintenance session to ensure that the CII is not disabled. (See **Port/DN Status** in the Maintenance chapter.)
2. While you are in the Maintenance session, run a connectivity test on the port connected to the CII.
3. Disable the port connected to the CII using the subheading:
2. **Port/DN Status**.
4. Enable the port connected to the CII using the subheading:
2. **Port/DN Status**.

External paging

1. Use the Button Inquiry feature (Feature] [*] Q) to verify the feature of a programmable memory button.
2. Check the wiring between the 50-pin connector and the paging amplifier or between the connections shown in the external paging wiring chart.

External paging wiring

Feature	Pin
Page out (Tip)	47 (Violet-Orange)
Page out (Ring)	22 (Orange-Violet)

3. Test external paging [Feature] [6] [2] to ensure that it is working. The output signal from the Norstar KSU is 775 mV across 600 Ω .

© 2005 Dell Inc. All rights reserved.

Glossary

A

Access code: A sequence of characters used to gain entry into any type of Norstar system programming.

Administration: A program that lets one person in your office (the System Coordinator) assign and maintain certain settings on the Norstar system.

Administration access code: To access Administration programming, enter

Feature * * A D M I N

You will be asked for an Administration password.

Administration password: A one-to six-digit password which is used to prevent unauthorized access to Administration programming. The Administration password can be assigned and changed in Administration programming.

Alarm code: A number which appears on the Alarm Telephone's display, informing you that the KSU has detected a fault in the system.

Alarm Set (Alarm Telephone): A telephone which is designated to receive reports of Norstar system problems. This function is usually assigned to a Prime Telephone, but this can be changed in Configuration programming.

Allow Redirect: A sub-heading in Administration programming that allows you to set whether Line Redirection can be used from that telephone.

Alternate language: When your system is first installed, all telephone displays will be in English. Norstar systems are available with either French or Spanish as the alternate language. To select the alternate language, enter

Feature * 5 0 2 .

To reselect English, enter

Feature * 5 0 1 .

Analog Terminal Adapter (ATA): A device which permits the connection of analog telecommunication devices such as FAX machines, answering machines, and single line telephones to the Norstar system. Programmed defaults for the ATA are automatically assigned by the Norstar system.

Answer button: A telephone button with an indicator which is used to monitor another telephone. The Answer button indicates incoming calls destined for the other telephone. Someone working at a telephone with Answer buttons (a receptionist, for example) can receive all ringing and visual indication of incoming calls for other telephones, and answer those calls when necessary.

240 / Glossary

One telephone can have up to four **Answer** buttons. An Answer button is automatically assigned to a telephone when that telephone is assigned an Answer DN.

Answer DN: The Directory Number (DN) of a telephone that is monitored by an Answer button. Up to four Answer DNs can be assigned to a telephone. This is done in Configuration programming.

Autobumping:

Feature

A feature that determines what the system does with new Call Log items when your Call Log is full. When Autobumping is ON, a new log entry causes the oldest entry to be deleted. If Autobumping is OFF, your Norstar system does not log calls when your log is full.

Autodial button: A memory button which, if programmed, provides one-touch dialing of external or internal numbers.

Autolog options:

Feature

A feature that allows you to select the type of calls that are stored in your Call Log. You can choose to log calls that were not answered by anyone within the system, to log calls that were unanswered at this telephone but answered elsewhere in the system, to log all calls answered and not answered at this telephone, or to not have calls automatically logged.

Automatic Dial: A feature that allows you to dial without having to pick up the receiver or select a line. You must have a prime line to use Automatic Dial.

Automatic Handsfree: A feature which automatically activates Handsfree operation when you make or answer a call. Automatic Handsfree is assigned in Administration programming.

Automatic Hold: A feature which automatically places an active call on hold when you select another line. Automatic Hold is programmed in Configuration programming.

Automatic Privacy: See Privacy.

Automatic Telephone Relocation: A feature which lets a telephone retain its personal and system programming when it is plugged into a different Norstar modular jack. Automatic telephone relocation is enabled in Configuration programming.

Auxiliary ringer: A separate external telephone ringer or bell which can be programmed to ring when a line or a telephone rings. An auxiliary ringer may be programmed to ring only when the system is in a particular service mode. Programming of an auxiliary ringer is done in Administration programming after the feature has been enabled in Configuration programming.

B

Background Music: A feature which lets you hear music from the speaker of your Nor-star telephone. It is available only if a music source has been attached to the KSU and the feature has been enabled in Configuration programming.

Busy Lamp Field (BLF): A device with a liquid crystal display (LCD) panel of indicators that shows the status of up to 24 telephones in the Norstar system. The BLF will show a telephone as busy if it is active on a call, has Do Not Disturb turned ON, or is being used for programming. The BLF attaches to the M7310 Telephone.

Button caps: Interchangeable plastic caps which fit over the buttons of Norstar telephones. They are used to indicate the features programmed onto each programmable memory button. Button caps are either pre-printed or have clear windows which allow you to insert labels.

Button Inquiry:

Feature * 0

With this feature you can check the function of each programmable button on your Norstar telephone.

Bypass Restrictions: Overrides any Call Restrictions applied to specific System Speed Dial numbers. Bypass Restrictions can be turned on in Administration programming.

C

Call Duration timer:
(Feature) 7 7

A feature that lets you see how long you spent on your last call or how long you have been on your present call.

Call Forward:

Feature 4

A feature that forwards all the calls arriving at your telephone, to another telephone in your Norstar system. To have calls forwarded outside the system, use Line Redirection. To cancel Call Forward, enter

Feature # 4 .

Call Forward No Answer: A feature which forwards all calls arriving at your telephone to another designated telephone in your Norstar system after a specific number of rings. Call Forward No Answer is assigned in Administration programming.

Call Forward On Busy: A feature which forwards all calls at your telephone to another designated telephone if your telephone is busy. This feature is assigned in Administration programming.

Call Forward Override:

Call Forward Override lets you call someone and ask them to stop forwarding their calls to you.

Call information:Feature

Call Information allows you to display information about incoming calls. For external calls, you can display the caller's name, telephone number and the line name. For an internal call, you can display the, name of the caller and their internal number. You can obtain information about ringing, answered, or held calls.

Call Log: A feature that accesses a record of incoming calls. The log could contain the following information for each call: sequence number in the Call Log, name and number of caller, long distance indication, indication if the call was answered, time and date of the call, number of repeated calls from the same source, and name of the line that the call came in on. See Autobumping, Autolog options, Enter Call Log, and Logit for further information.

Call Park:Feature

With this feature you can place a call on hold so that someone can retrieve it from any other telephone in the Norstar system by selecting an internal line and entering a retrieval code. The retrieval code appears on the display of your telephone when you park the call. You can park up to nine calls on the system at one time.

Call Park Callback: See Callback.

Call Park prefix: The first digit of the retrieval code of a parked call. This digit cannot conflict with the first digit of any existing DN, Line Pool access codes, the Direct-dial digit, or the external line access code. The default Call Park prefix digit is "1". It may be set to none, in which case Call Park is disabled. Call Park prefix is assigned in Configuration programming.

Call Pickup Directed:Feature

A feature which lets you answer a call ringing at any Norstar telephone by entering the internal number of that telephone before taking the call. Call Pickup Directed is enabled in Configuration programming.

Call Pickup Group: See Pickup Group.

Call Queuing:Feature

If you have several calls waiting at your telephone, you can invoke the Call Queuing feature to answer them in order of priority. Priority is given to incoming calls, followed by callback and camped calls.

Callback: If you park, camp, or transfer a call to another telephone and it is not answered there, it will ring again at your telephone. How long the system will wait before Callback occurs is set in Configuration programming.

Camp-On:

Feature 8 2

A feature which lets you re-route a call to a telephone even if all the lines on that telephone are busy. To answer a camped call, use Call Queuing or select a line if the camped call appears on your telephone. Priority is given to queued calls over camped calls.

Camp timeout: The length of a delay before a camped call is returned to the telephone which camped the call. The length of delay is set in Configuration programming.

Capabilities: A section in Administration programming, that covers dialing filters, remote access packages, set abilities, and line abilities which can be assigned to **Norstar** lines, telephones, or Class of Service passwords.

Central Answering Position (CAP): An M7324 Telephone which has been designated a CAP in Configuration programming. The CAP provides backup answering and can be used to monitor the telephones within a **Norstar** system. One or two CAP modules can be attached to a CAP to increase the number of lines it can handle.

Central Answering Position (CAP) module: A CAP module is connected to an M7324 Telephone and provides 48 additional buttons which can be used as **Autodial** buttons or **Feature** buttons. A maximum of two CAP modules can be connected to a single M7324 Telephone.

Class of Service (COS): The set of **Norstar** features and lines available to the user for a call. The Class of Service for a call is determined by the Dialing Filters and Remote Access Packages assigned to the telephone in Administration programming. Class of Service for a call can be changed by entering a six digit Class of Service password. (Internal users cannot change their access to features with a COS password, only their dialing filters.) Class of Service and Class of Service passwords are assigned in Administration programming. See Remote Access.

Class of Service password:

Feature 6 8

A Class of Service password is a six digit code that lets you switch from your current Class of Service to one that lets you dial numbers prohibited by your current Class of Service.

Conference:

Feature 3

The Conference feature allows you to establish a three-person call at your **Norstar** telephone.

Conference using privacy:

[Feature] [8] [3]

Normally your calls are private; no one else can pick up your line and join in. You can turn privacy off for a call, allowing another person with the same line to press the line button and join in your conversation.

Contrast Adjustment:

[Feature] [*] [7]

Allows you to set the contrast level of your telephone display.

Control Telephone: A Control Telephone can place the lines for which it has responsibility in or out of a Service Mode. The Direct-dial Telephone is a Control Telephone for directing calls to the Extra Direct-dial Telephone. A telephone is made a Control telephone and has lines assigned to it in Administration programming.

COS: See Class of Service.

Cursor: A short horizontal line which appears on the Norstar telephone display to indicate that characters can be entered using the dial pad.

D

Data Communications Interface (DCI): A Norstar device which lets you attach an RS-232 data device to the Norstar system.

Data terminal: A device such as a modem which can be used to transfer data instead of sound over a telephone network. You cannot use Norstar programming to set up such devices. See the documentation that accompanies the device.

Date: See Show Time or Time and Date.

Defaults: The settings for all Norstar features when the system is first installed. Settings are changed from their defaults in Administration programming and Configuration programming. In this manual, default settings are shown in bold text.

Delayed Ring Transfer (DRT) to Prime: After a specified number of rings, this feature transfers an unanswered call on an external line, to the Prime Telephone associated with that line. This feature is activated in Configuration programming.

Dialing filter: Through a combination of restrictions and exceptions, dialing filters prevent certain telephone numbers from being dialed. Dialing filters can be applied to lines (line filters, remote filters), to sets (set filters), to specific lines on a set (line/set filters), and to Class of Service passwords (user filters, remote filters). The Norstar system can handle up to 100 dialing filters.

Dialing Modes:Feature * 8 2

This feature allows you to set the dialing mode of your telephone. Norstar supports three dialing modes; Automatic Dial, Pre-Dial, and Standard Dial. All three modes support on-hook dialing (meaning you can dial a call without picking up the receiver). The special features of the Automatic and Pre-Dial modes are available only when you dial on-hook.

Direct-dial: A feature which lets you dial a designated telephone in your Norstar system with a single digit. As many as five direct dial sets can be established. Each telephone in the system is assigned to one Direct-dial telephone. There is a single, system wide digit for calling the assigned Direct-dial telephone of any telephone. Direct-dial telephones are established in Administration programming. Telephones are assigned to a Direct-dial telephone in Administration programming.

Direct-dial #: A digit used system wide to call a direct dial telephone. The digit is assigned in Configuration programming.

Direct-dial number: The digit used to call the Direct-dial telephone.

Direct inward System Access (DISA): The feature which lets remote users dial directly into the Norstar system and use Norstar features. Callers will hear stuttered dial tone and will be required to enter a Class of Service password to gain access to the system. See Remote Access.

Directed Pickup: See Call Pickup Directed.

Directory Number(DN): A unique number which is automatically assigned to each telephone or data terminal. The DN, also referred to as an internal number, is often used to identify a telephone when settings are assigned during programming. Default DN assignments start at 21 in a two-digit (non-expanded) system and 221 in a three-digit (expanded) system.

DISA DN: The received number assigned to the Norstar Direct Inward System Access facility. If a caller dials a number which is assigned to the DISA DN, the caller hears stuttered dial tone and must enter a Class of Service Password. Once the password is accepted, the caller hears system dial tone and can use Remote Access features. See Remote Access.

Disconnect Supervision: A setting which enables the Norstar system to detect if an external caller hangs up. Once an external caller hangs up, the Norstar system can disconnect its line. Disconnect Supervision is enabled in Configuration programming.

Display: A liquid crystal display (LCD) on the Norstar telephone that guides you through feature operation and programming.

Display button: The Norstar M7310 Telephone and M7324 Telephone are each equipped with three buttons located directly beneath the display. During feature operation or programming, some or all of these buttons may be used to provide further options. If an option is available, it is shown in the bottom row of the two row display, directly above the corresponding display button. Display buttons are represented in this manual as underlined capital, e.g. OK.

Display digits: In Administration programming, this subheading lets you set whether an assigned name or the actual number will be displayed when someone uses a system speed dial code.

DN: See Directory Number.

Do Not Disturb:

Feature 8 5

A feature that stops calls from ringing at your telephone. Only Priority Calls will ring at your telephone. A line button will flash when you receive a call, but the call will not ring. To cancel Do Not Disturb, enter

Feature # 8 5.

DRT delay: The number of rings before a Delayed Ring Transfer occurs. This is assigned in Configuration programming.

DRT to Prime: See Delayed Ring Transfer to Prime.

E

Emergency Telephone: A single line telephone (also referred to as a 500/2500 telephone) that becomes active when there is no power to the Key Service Unit.

Enter Call Log:

Feature 8 1 2

Enter your Call Log to view stored information:

Event message: Event messages are stored in the system log and displayed during a Maintenance session. They record a variety of events and activities in the Norstar system.

Exceptions: One component of a Dialing filter. Exceptions are numbers you can dial even if they are forbidden by a **more** general Restriction. See Restrictions.

External call: A call to a destination outside the Norstar system.

External Call Forward: See Line Redirection.

External code: The number you dial to get an external line. By default it is 9, but this can be changed in Configuration programming. You do not always need an external code. It is primarily to support the M7100 Telephone and single line telephones using an Analog Terminal Adapter.

External line: A line on your Norstar telephone used for making calls to destinations outside the Norstar system.

External music source: See Music source.

External paging: A feature you can use to make voice announcements over an externally-mounted loudspeaker connected to the Key Service Unit. The external speaker is not a Norstar component and must be supplied by the customer.

Extra-Dial set: In Administration programming, this heading lets you assign an extra Direct-dial set when a service mode is active. You can have one Extra-Dial set for each of the three service modes.

F

Feature button: Many Norstar features are invoked by pressing the Feature button followed by a Feature code. The feature button is also used to exit a feature.

Feature Cartridge: A replaceable cartridge containing the Norstar features. The Feature Cartridge, a combination of a Data Cartridge and a Software Cartridge, is inserted into the Key Service Unit.

Feature code: A number that is used to activate a particular feature.

Feature programming:

Feature * 3

Allows you to program a feature code onto a memory button. To erase a memory button, enter

Feature * 1.

Forward: See Call Forward.

Forward delay: The number of rings before an unanswered call is forwarded to another telephone when the Call Forward No Answer feature is ON. Forward delay is assigned in Administration programming.

Forward No Answer: See Call Forward No Answer.

Forward On Busy: See Call Forward On Busy.

Full Autohold (on idle line):
When this feature is ON, if you select an available line, and then do something which selects another line, the first line is put on hold. Full Autohold is enabled in Configuration programming.

Full Handsfree: See Handsfree.

G

Group Listening:

A feature which allows you to have others in your office hear a caller through your phone's speaker. The caller hears you only when you speak into the receiver and cannot hear other people in the office. You can cancel Group Listen for the current call. Group Listen is cancelled automatically when you hang up the Group Listen call. To cancel, enter

.

H

Handsfree:

A feature you can use to make calls without using the telephone receiver. Full Handsfree is activated in Administration programming. When it is activated, a Handsfree/Mute button is automatically assigned to the telephone.

Handsfree (HF) Answerback:
When activated, this feature automatically turns ON the microphone at a telephone receiving a Voice Call so that the person receiving the call can respond without lifting the receiver. It is activated in Administration programming.

Handsfree/Mute button: See Handsfree.

Headset: A head-mounted or ear-mounted telephone receiver that is used instead of the hand-held receiver. Headsets are not Norstar components and must be supplied by the customer.

Held (Line) Reminder: A Norstar telephone rings and displays the message **He**ld call when an external call has been placed on hold for a certain period of time. The Held Line Reminder feature and Remind delay are set in Configuration programming.

HF Answerback: See Handsfree Answerback.

Hold button:

This button is used to suspend calls so that the person using the telephone can perform another task without disconnecting the caller.

To place a call on Exclusive Hold so that it can be retrieved only at your telephone, enter

or
 .

Hookswitch Flash: See Link time.

Host System Signaling: (Also referred to as End-to-End Signaling.) Norstar telephones can access a remote system or dial a number on an alternate carrier by means of Host feature activation, such as Link, Pause and Run/Stop.

Hotline: This feature automatically calls a pre-assigned number when the telephone's receiver is lifted or the Handsfree/Mute button is pressed. A Hotline number can be an internal or external number. Hotline is assigned in Administration programming.

|

I/C: An abbreviation of Intercom button.

Intercom button: A button which provides access to internal lines used for calls within a Norstar system and access to external lines through a Line Pool or external code. A telephone may be assigned zero to eight Intercom buttons. This is done in Configuration programming.

intercom keys: See Intercom button.

Internal line: A line on your telephone dedicated to making calls to destinations inside your Norstar system. An internal line may still connect you with an external caller if you use it to access a line pool or to pick up a call using Norstar call handling features such as Call Park or Call Pickup Directed.

Internal number: A number (also referred to as a Directory Number or DN) that identifies a Norstar telephone or device.

Internal user: Someone using a Norstar telephone within a Norstar system.

K

Key Service Unit (KSU): The central hardware component in the Norstar system. The KSU has its own processor and memory, and provides a physical point of connection for the various types of devices, telephones, and expansion modules used in Norstar. The KSU can function on its own as a basic system (with 24 Norstar telephones and 8 external lines), or with the addition of a Trunk Module (TM) which supports more external lines, or a Station Module (SM) which supports more Norstar telephones.

L

Last Number Redial:
 feature

A feature that allows you to redial the last external number you dialed.

Line: The complete path of a voice or data connection between one telephone (or other device) and another.

Line abilities: In Administration programming, the heading under which you assign Line Filters, Remote Filters, and Remote Access Packages to lines.

Line filter: See Dialing filter.

Line names: In Administration programming, this sub-heading allows you to assign names to external lines.

Line number: A number which identifies an external line. The total number of lines depends on how many Trunk Modules are installed.

Line Pool:

Feature

A group of lines used for making external calls. Line Pools provide an efficient way of giving a telephone access to external lines without taking up many line buttons. A line is assigned to be a member of a Line Pool in Configuration programming.

Line Profile: A feature you can use to review the settings that have been programmed to lines in Configuration and Administration programming. The settings cannot be changed with this feature. Line profile is available only on the M7310 and M7324 telephones.

Line Redirection:

Feature

A feature which allows you to redirect all calls on an incoming line to a destination outside the Norstar system. Once a line is redirected it cannot be answered within the Norstar system. The system may be set up to give a brief ring when a call comes in on a redirected line. This feature differs from Call Forward in two ways. It redirects only external calls (not internal calls) and it redirects calls to destinations outside the system. Call forward redirects calls only to destinations inside the Norstar system. See Call Forward and Redirect Ring. To cancel Line Redirection, enter

Feature # .

Link:

Feature

If your Norstar system is connected to a Private Branch Exchange (PBX), you can use a Link signal to access special features. The Link signal can also be included as part of a longer stored sequence on an External Autodial button or in a Speed Dial code. The Link symbol () uses two of the 24 spaces in a dialing sequence.

Logit:

Feature

Logit lets you manually log call information when you are connected to a call.

Long Tones:

[Feature] [8] [0] [8]

A feature that lets you control the length of a tone so that you can signal devices such as fax or answering machines which require tones longer than the standard 120 milliseconds.

M

M7100 Telephone: A telephone with a single line display and one programmable memory button without an indicator.

M7208 Telephone: A telephone with a single line display and eight programmable memory buttons with indicators.

M7310 Telephone: A telephone which has a two line display, three display buttons, 10 programmable memory buttons with indicators, and 12 dual memory programmable buttons without indicators. An M7310 can be equipped with a Busy Lamp Field.

M7324 Telephone: A telephone with a two line display, three display buttons, and 24 programmable memory buttons with indicators. An M7324 telephone can be equipped with a CAP module.

M7900 Telephone: A telephone with a touch screen display which replaces the display and memory buttons of other Norstar telephones. It provides simplified access to Norstar Features and an interface to computer driven applications.

Maintenance: A type of programming that is used to diagnose and repair problems in the Norstar system.

Maintenance requires no programmable settings.

Memory buttons: Buttons which can be programmed to dial frequently used features or numbers automatically. See M7100, M7208, M7310, M7324 and M7900 telephone entries for their exact memory button configurations.

Message:

A feature that allows you to send a message to another Norstar user. The Message feature also lets you know if you have any messages waiting, and it maintains a Message Waiting List to keep a record of your internal messages and your (external) voice mail messages.

To leave a message on the display of another telephone in your Norstar system, enter [Feature] [1]. On a telephone with a two-line display, this code will also allow you to show and scan the messages you have sent. To cancel a message that you have sent, enter

[Feature] [#] [1].

To erase an item in your Message Waiting List, enter

[Feature] [#] [6] [5].

Move Line buttons:

[Feature] [*] [8] [1]

A feature that allows you to move external lines to different buttons on your telephone.

Music source: A radio or other source of music can be connected to the Key Service Unit to provide music for the Music on Hold and Background Music features. A music source is not part of the **Norstar** system and must be supplied by the customer.

N

Names: Names can be assigned to System Speed Dial numbers, external lines, telephones, and Service Modes. This is done in Administration programming. You can use up to sixteen characters to name a System Speed Dial number, and seven characters to name a telephone, line, or Service Mode.

If a Name has not been assigned, the line number or DN will appear on the display instead of a Name.

Night Service: See Service Modes.

Norstar Programming

Overlay: A paper template which is placed over the top four memory buttons with indicators on the M7310 or M7324 Telephone during programming. The overlay labels indicate the special function that each of the four buttons takes on in programming.

O

On hold: A setting, programmed in Configuration programming, that controls whether external callers hear music, periodic tones, or silence when they are placed on hold.

Overlay: See **Norstar** Programming Overlay.

P

Page Zone: An area in the office that receives internal Page announcements independently of the rest of the office. Each Page Zone is identified by a number. Telephones are assigned to Page Zones in Administration programming.

Paging:

Feature

A feature you can use to make announcements over the **Norstar** system. To choose Internal Page (announce over the telephone speakers), enter after the Paging code. To choose External Page (announce over a customer supplied loudspeaker) enter after the Paging code. For both Internal and External Page, enter after the Paging code.

Park prefix: See Call park prefix.

Park timeout: The time before an unanswered parked call is routed back to the telephone which parked it. Park timeout is in Configuration programming. See Call Park.

Password: A password is a specific sequence of digits that you enter to gain access to Norstar programming, to override dialing restrictions, or to use Remote Access with DISA. Passwords are also required for System Startup and Administration programming. See Class of Service password.

Pause:

Feature

A feature that enters a 1.5 second delay in a dialing sequence on an external line. This is often required for signaling remote devices, such as answering machines, or when reaching through to PBX features or Host systems. The Pause symbol (Ⓔ) uses one of the 24 spaces in a dialing sequence. For Pulse Dialing, inserts a 1.5 second pause into the dialing sequence.

Personal Speed :

Feature

Two-digit codes (71-94) can be programmed to dial external telephone numbers. Personal Speed Dial numbers are programmed for each telephone, and can be used only at the telephone on which they are programmed.

Pickup Group:

Feature

A telephone can be placed into one of nine Call Pickup Groups. A call ringing at a telephone within a Pickup Group can be picked up at any other telephone within the same Pickup Group. A telephone is assigned to a Pickup Group in Administration programming.

Pool: See Line Pool.

Pre-dial: A feature that allows you to enter a number and check it on your telephone display before it is actually dialed. If the number is incorrect, you can edit it. The number is dialed only when you pick up the receiver or select a line.

Prime line: The line on your telephone which is automatically selected when you lift the receiver, press the Handsfree/Mute button or use an external dialing feature. A Prime Line is assigned to a telephone in Configuration programming.

Prime Set (Prime Telephone):

A telephone which provides backup answering for incoming calls on external lines. The Prime Telephone for a line will ring for any unanswered calls on that line. A Prime Telephone is assigned to a line in Configuration programming.

Priority Call:Feature

If you get a busy signal when you call someone in your office, you can interrupt them for an urgent call. This feature is enabled for a telephone in Administration programming.

Privacy: This feature determines whether a **Norstar** user may select a line in use at another telephone and join an established call. Privacy is enabled in Configuration programming, but can be turned ON and OFF by users during individual calls.

Private line: See Private to.

Private network: A telephone network consisting of owned or leased telephone lines used to connect different offices of an organization independently of the public network.

Private to: A line can be assigned, in Configuration programming, to one telephone as a Private line. The line cannot appear on any other telephone, except the Prime Telephone for that line. Private lines cannot be placed into Line Pools.

Programmed release:

Feature

A feature that performs the function of the button in a programmed dialing sequence.

Programming: Setting the way the **Norstar** system will work. Programming includes system-wide settings and individual telephone and line settings.

Programming Overlay: See **Norstar Programming Overlay**.

Programming reminders: Charts on which you can record some commonly-used settings from Administration programming to keep the **Norstar** system's records up-to-date.

Public line: An external line which can be assigned to any telephone and to many telephones. A line is assigned as Public in Configuration programming.

Public network: The regular telephone network which connects most homes and businesses.

Pulse/Tone Dialing: An external line setting for pulse or tone dialing. Pulse is the traditional method of dialing used by rotary dial or push button single-line telephones. Tone dialing allows telephones to communicate with other devices such as answering machines. Tone dialing is required to access the features that PBX systems may offer or to use another **Norstar** system remotely.

R

Recall: See Link time.

Receiver The handset of a telephone.

Redirect ring: In Administration programming, this subheading allows you to set whether a line that has been redirected through Line Redirection will give a short ring on those sets on which the line appears.

Remind delay: When a call has been on hold for a set period, the telephone beeps and displays the message **He1 d call** . This period is the Remind delay. It is set in Configuration programming.

Remote access: The ability to dial into a **Norstar** system from outside the system and make use of selected **Norstar** features. The lines, features, and dialing capabilities available to a remote user are determined by the Class of Service. If the remote access line is answered with DISA, the user must enter a Class of Service password to gain access to the **Norstar** system's features.

Remote access dial filter: See Remote filter.

Remote access package: In Administration programming, this subheading lets you set up access to Paging and Line Pools for remote users.

Remote capability: A subset of **Norstar** features that are available to users connected through remote access.

Remote filter: A dialing filter applied to a line in order to control which digits can be dialed during an incoming remote access call. It is the equivalent of a set filter for a remote user.

Remote paging: This feature allows remote users to use the **Norstar** paging feature. Access to this feature is governed by the Class of Service for the call. See Remote Access and Class of Service.

Remote User: Someone who calls into a **Norstar** system from a telephone outside that system and uses **Norstar** features or lines. See Remote Access.

Restrictions: One component of a Dialing filter. Restrictions are numbers you cannot dial when that dialing filter is in effect. See Exceptions.

Ring Again:

Feature 2

A feature that can be used when you can't get through to someone on your **Norstar** system because their telephone is busy or there is no answer. Ring Again instructs the **Norstar** system to inform you when they hang up or next use their telephone. You can cancel your Ring Again request by entering

Feature # 2 .

Ring Type:

Feature * 6

A feature that allows you to select one of four distinctive rings for your telephone.

Ring Volume:Feature * 8 0

A feature that allows you to set the volume at which your telephone rings.

Ringing: A setting which assigns a line to ring or not ring at a telephone. If a line has been assigned as "No ring", an incoming call is shown by a flashing indicator only. Ringing is set in Configuration programming.

Ringing Sets (Ringing Telephones): Those telephones which have been assigned to ring when a line has been placed into a Service Mode. Ringing Telephones are assigned in Administration programming.

Rls button: The Release button ends a call in the same way that hanging up the receiver does. It may also be used to end Startup, Configuration programming, Administration programming, Maintenance sessions and feature operations.

Run/Stop:Feature * 9

A feature that creates a breakpoint in a programmed external dialing sequence. When you press a programmed key, the system dials the number up to the run/stop. When you press it again, the system dials the digits following the run/stop.

S

SAPS: See Station Auxiliary Power Supply.

Saved Number Redial:Feature 6 7

A feature that allows you to save the number of the external call you are on (providing you dialed the call) so that you can call it again later.

Selective line redirection: See Line Redirection.

Service Modes:Feature 8 7

A feature that places one or more lines into a Service Mode. This is usually done to provide special ringing and telephone access after normal off ice hours, or when there are few people available to answer calls. Service Modes settings are assigned in Administration programming. To return to normal operation or cancel the manual override of an automatic mode, enter

Feature # 8 7 .

You cannot cancel an automatic mode with this code.

Set: A telephone.

Set ability: In Administration programming, the subheading under which set filters, line/set filters, and a variety of system features are assigned to individual telephones.

Set Copy: A programming section that allows you to copy programmable settings from one telephone to another of the same type. Set Copy provides two options: duplicating System Data and User Data, or duplicating System Data only. Set Copy does not provide the same copy capability as the **COPY** display button, which is more selective of the settings that can be duplicated.

Set filter: See Dialing filter.

Set lock (Telephone lock): This feature allows you to limit the number of features that may be used or programmed at a telephone. Full set lock allows very few changes or features, Partial set lock allows some changes and features, and No set lock allows any change to be made and any feature to be used. Set lock is assigned in Administration programming.

Set Names: In Administration programming, this sub-heading allows you to assign Names of up to seven characters to telephones.

Set Profile: A feature you can use to review the settings that have been assigned in Configuration programming and Administration programming. The settings cannot be changed with this feature. Set profile is available only on the M7310 and M7324 telephones.

Set Relocation: See Automatic Telephone Relocation.

Shift button: A small triangular button beside the dual memory buttons on the upper half of the M7310 Telephone. You press the shift button to store or access features on the top half of the dual memory buttons.

Show Time:

Feature

While on a call, accessing this feature lets you see the current date and time on the Norstar telephone display.

Station: An individual telephone or other Norstar device.

System Coordinator: The person responsible for customizing the Norstar system through Administration programming and for helping co-workers use the Norstar system.

System Data: An option in the Set Copy function. System Data refers to the system settings which apply to all telephones and lines. System Data consists of the programmable settings from System Startup and Administration programming. It also includes the settings programmed in Configuration programming.

System Speed Dial: In Administration programming, a heading under which you can assign up to 70 numbers as System Speed Dial numbers.

System Speed Dial code: A Two-digit code (01 to 70) that can be programmed to dial a telephone number up to 24 digits long. System Speed Dial codes are programmed for the entire Norstar system in Administration programming.

System Speed Dial Name: In Administration programming, a subheading under which you can assign a name to a System Speed Dial number.

System Startup: When a Norstar system is first installed and powered up, System Startup must be performed before any programming can be done. Startup initializes the system programming to defaults.

System Startup access code: To begin System Startup, enter * * S T A R T . An Installer password is required before System Startup can begin.

T

Tandem call: A call established when a remote user dials into the Norstar system and uses the system to place an outgoing call. The combination of the incoming and outgoing calls forms a tandem call. See Remote Access.

Time and Date: The current Time and Date appear on the display of idle Norstar telephones. Time and Date can be changed in Administration programming.

Timed release:

A feature that inserts a 1.5 second pause into a sequence. You can use it in a dialing sequence for accessing a remote system such as a PBX. You can also dial it if you wish to release a call from your line but keep the line for another call.

Transfer:

A feature which lets you redirect a call to another telephone in your Norstar system, over a network or outside your Norstar system. There are four types of Transfer; Transfer using Hold, Transfer with Announcement, Transfer without Announcement, and transfer using Unsupervised Conference.

Transfer Callback: If a transferred call is not answered after a specific number of rings, the call will return to the telephone which made the transfer. The number of rings is assigned in Configuration programming. Transfer Callback does not apply to calls transferred externally.

Trunk: The physical connection between the Norstar system and the outside world using either the public telephone system or a private network.

Trunk Answer:

[Feature] 8 0 0

A feature you can use to answer a call on any line that has an active Service Mode, even if that line does not appear on your telephone. Trunk Answer is enabled in Administration programming.

U

Unsupervised line: A line for which disconnect supervision is disabled. If an external caller hangs up, the Norstar system does not detect the disconnection and does not hang up its line. See Disconnect Supervision.

User Data: User Data is an option in the Set Copy feature. User Data refers to the personal settings which are unique to an individual telephone, and are not programmed in Configuration or Administration programming. User Data is programmed at each telephone. These settings, for example, include Personal Speed Dial and the assignment of programmable memory buttons.

User Filter: See Dialing filter.

V**Voice Call:**

[Feature] 6 6

A feature you can use to make an announcement or begin a conversation through the speaker of another telephone in the Norstar system. The telephone you call will not ring. Instead, the person you call will hear a beep and then your voice. Their telephone will beep periodically to remind them that their microphone is open.

Voice Call deny:

[Feature] 8 8

A feature that prevents your telephone from receiving Voice Calls. To cancel Voice Call deny, press [Feature] # 8 8

Voice Message Center: If you have subscribed to Call Display services you can receive visual Voice Message Waiting Indication, providing your telephone has a display. If you have Voice Message Waiting Indication, you can program the telephone numbers required to access up to five different Voice Message Centers. You can also program which of the five Centers is to be accessed by each specific line.

Index

A

Access code
 Line pool 149
 Startup 95
Access codes
 Line pool in a network 13
Administration
 defaults 102
Alarm Codes
 in System Administration
 Log 184
 in System Test Log 181
 Overview 185
 table of 186
Alarm telephone 145, 185
Answer buttons 135
Answer DN 135
 Ringing 136
Answer mode 119
 programming 127
Answer with DISA
 programming 128
ATA
 troubleshooting 203
Attendant by-pass 121
Auto DN 123
 characteristics 145
 deleting 145
 length 145
Auto-answer
 AUTO DN 123
 DISA 122
 DISA DN 123
 Network Troubleshooting
 211
 trunks 118

Auto-answer trunk
 definition 4
Autodial cannot be
 programmed 207,219,
 222
Autohold 130
Auxiliary Equipment
 Wiring chart 83
Auxiliary ringer
 Installation 63
 programming 63,133
 troubleshooting 203, 235
Auxiliary ringing
 on target lines 15

B

B1 Directory Numbers 81
B2 Directory Numbers 81
Background Music 143
 Installation 63
 troubleshooting 221
BLF
 troubleshooting 203
Bounce 77
Bridge taps 30
Busy tone
 Cadence 75,
Buttons
 Answer 59
 Handsfree/Mute button 59
 External line 60

C

Cable
 length 30
Cable routing 48
Cadences 75

-
- Call Forward
 - Delayed Ring Transfer 140
 - Call Identification Interface
 - (see CII)
 - Call Handling 139
 - capacity 2
 - defaults 100
 - Call Park
 - changed DNs 141
 - Park prefix 140
 - Timeout delay 141
 - Callback
 - delay 140
 - on target lines 15
 - Camp on
 - on target lines 15
 - Camp timeout delay 141
 - CAP
 - Assigning to system 146
 - relocating 146
 - CAP modules
 - line assignment 135
 - troubleshooting 203
 - Cartridge
 - troubleshooting 204
 - Central Answering Position
 - (See CAP)
 - CII
 - troubleshooting 236
 - Class of Service
 - defaults 105
 - Password
 - DISA 123
 - Codes
 - in System Administration
 - Log 184
 - Configuration
 - Answer mode 127
 - Answer with DISA 128
 - Call Handling 139
 - Copying data 124
 - Full Autohold 130
 - Gain 129
 - Line Data 131
 - Miscellaneous 143
 - Norstar hardware 36
 - Password
 - changing 150
 - programming 111
 - Received number 130
 - Signal type 128, 129, 130
 - System Data 151
 - Trunk mode 127
 - Trunk type 126
 - Confirmation tone
 - Cadence 75
 - Connectivity Test 176
 - procedures 177
 - Result Codes 179
 - results 178
 - Control Circuit Interface 92
 - copy 155
 - System Data 155
 - User Administration data
 - 155
 - Copying data 124
 - COS (See Class of Service)
 - Cross Connections
 - E & M/DISA Trunk Cartridge
 - 87
-
- D**
-
- Data Cartridge 41
 - Delay
 - Camp timeout 141
 - Delayed Ring Transfer 140
 - Disconnect Supervision 148
 - Held Line Reminder 139
 - Host 148
 - OSI 148
-

-
- Park timeout 141
 - Transfer Callback 140
 - Delay Dial 128, 129, 130
 - Delayed Ring Transfer 140
 - Delay 140
 - on target lines 15
 - Device
 - State 166
 - Version number '166
 - Device type 165
 - Diagnostics
 - overview 176
 - Dial mode
 - programming 129
 - Dial tone
 - DISA 122
 - Host delay 148
 - troubleshooting 214
 - Dialing filters 2
 - defaults 103
 - Dialing plan 2, 13
 - DID lines
 - as Prime line 138
 - in line pools 232
 - DID trunk cartridge
 - Emergency telephone 92
 - troubleshooting 209
 - Wiring chart 93
 - DID trunks 1, 120
 - as Prime line 9
 - Configuration requirements 9
 - incoming calls 9
 - Remote access 123
 - Signal setting 128, 129, 130
 - Direct Inward Dial (See DID)
 - Direct Inward System Access (See DISA)
 - Direct-dial
 - DN length 144
 - programming 144
 - Directed pickup
 - programming 141
 - Directory numbering
 - with six-port Expansion Cartridge 80
 - with two-port Expansion Cartridge 80
 - Directory numbers 79
 - B1 and B2 81
 - in a network 13
 - DISA 2, 7, 19, 122
 - Calling Norstar with 226
 - dial tone 122
 - DN 123
 - DISA DN
 - characteristics 145, 146
 - deleting 145, 146
 - length 145, 146
 - programming 144
 - Disabling 163, 167
 - modules 172
 - Disconnect supervision 119, 127
 - troubleshooting 211
 - DN
 - Changing 151
 - length 152
 - cautions 153
 - changing 153
 - DS-30 cables
 - Installation 52
 - DTMF
 - on E & M trunks 124
 - receiver inaccessible 212
 - DTMF signaling
 - programming 129
-

E

E & M

Configuration requirements
7

E & M Trunk Cartridge

Cross connections 87
troubleshooting 209
Wiring charts 89

E & M trunks 1, 120

as Prime line 7
Answer mode 127
definition 5
Full Autohold 130
Gain 129
incoming calls 7
Private Network 123
pulse signaling 129
Remote access 122, 123
Signal setting 128, 129, 130
voltages on leads 225

Electromagnetic compatibility
72

'Electromagnetic interference
29

Electrostatic interference 29

Emergency Telephone

connecting to KSU 53
on DID trunk cartridge 92
testing 54
wiring 53
with E & M/DISA Trunk
Cartridge 87

Emissions

Radiated 72

Enabling 175

Enabling the device 169

Environmental requirements
30

Environmental specifications
76, 77

Event messages

Complete list of 193
overview 190
Severity 190

Expansion Cartridge

installation 43
module numbering 170
Port numbering 80
troubleshooting 205

Extenal lines 60, 118

line numbers 117
Wiring chart 83

External paging

troubleshooting 237

F

Feature Cartridge 41, 204
troubleshooting 204

Features

troubleshooting 203

Filters 10

Full Autohold 130

G

Gain

programming 129

General Administration

defaults 102

H

Handsfree/Mute 59

Headset

troubleshooting 203

Hearing Aid Compatibility 72

Held Line Reminder 139

delay 139

on target lines 15

Hold

programming music 142
 Host delay 148
 Host System Signaling 249
 Humidity 29
 requirements 77
 Hung lines
 troubleshooting 215

|

Impedance
 External music source 63
 Installation
 Auxiliary Ringer 63
 brackets 38
 DS-30 cables 52
 Emergency Telephone 53
 Environmental requirements
 30
 External paging system 65
 Internal 30
 mounting brackets 38
 music 63
 Norstar telephones 55
 power bar 66
 powering up 67
 turning system ON 67
 Wall-mounted telephone 56
 Installer password (See also
 Configuration
 password)
 changing 150
 Intercom buttons
 default assignment 59
 programming 137
 Interconnect 72
 Interference 29

K

KSU
 Connecting an Emergency
 Telephone 53
 Directory numbers 80
 disabling 172
 enabling 175
 External lines
 Wiring chart 83
 hanging on mounting
 brackets 35
 Internal lines
 Wiring chart 84
 physical dimensions 37
 Port numbers 80
 Power source 29
 Relay contacts 65
 Status 171
 troubleshooting 204, 207
 turning ON 67

L

Line Access 134
 Line assignment
 programming 135
 Line buttons
 maximum number of 135
 Line Data
 Copying 124
 defaults 98
 programming 131
 Line filters 10
 Line per set filters 10
 Line pools 131
 Access 132
 Access code
 priority over External line
 access code 150
 length 150

-
- DID lines 232
 - in a dialing plan 13
 - programming 149
 - as Prime line 138
 - programming 132
 - Line Profile
 - troubleshooting a network 199
 - Line redirection 27
 - Hung lines 215
 - Lines
 - disabling 167
 - enabling 169
 - External 118
 - line numbers 117
 - pools 131
 - Prime 138
 - Private 131
 - Public 131
 - Ringling
 - Programming 136
 - search for idle 132
 - Target 1, 4, 117, 121
 - Tie 1
 - troubleshooting when hung 215
 - Link Time 146
 - Logs
 - System Administration 183
 - System Test 180
 - Loop resistance 30
 - Loop Start Trunk Cartridge
 - troubleshooting 209
 - Loop start trunks 1, 119
 - as Prime line 5
 - Configuration requirements 5
 - dial mode 129
 - Full Autohold 130
 - Incoming calls 5
 - Remote access 122
 - Loop Supervision 127
- ## M
-
- M7100 telephone
 - Intercom buttons 137
 - M7324 telephone
 - as CAP 146
 - Maintenance
 - Alarm codes 185
 - Diagnostics 176
 - Emergency Telephone 54
 - Event Messages 190
 - Records 195
 - System Test Log 180
 - Maintenance session
 - beginning 160
 - Manual-answer
 - trunks 118
 - Miscellaneous 143
 - defaults 101
 - Modular Telephone Feature
 - Card 110
 - Module Status
 - overview 170
 - procedure 171
 - Mounting brackets 35
 - Music
 - background 143
 - installation 63
 - License for 73
 - on Hold 142
 - troubleshooting 221
- ## N
-
- Names
 - defaults 102
 - Network
 - Configurations 17
 - Private 22
-

Public 18
 Security 2, 10
 unified dialing plan 13
 Network Troubleshooting
 far-end disconnecting 217
 Networking 1
 Call handling capabilities 15
 COS
 getting wrong 227
 DISA
 getting wrong tone 226
 not getting through 224
 Remote features 229
 No free lines 218
 Not in **Service**
 DTMF misconfiguration 217
 Numbering
 Directory Numbers 79
 Ports 79
 Numbers
 entering 116
 viewing 116

O

Off premise extension 1, 51
 Open Switch Interval 127
 programming 148
 Optional Equipment
 troubleshooting 202
 OPX (see off premise
 extension)
 OSI (See Open Switch
 Interval)
 Overflow Call Routing 133
 on target lines 16
 Overflow tone
 Cadence 75

P

Paging
 installation 65
 troubleshooting 236, 237
 Park prefix
 programming 140
 Park timeout delay 141
 Passwords
 Configuration 150
 cos 7
 defaults 106
 Pickup
 Directed 141
 Port Numbering
 default KSU 80
 with six-port Expansion
 Cartridge 80
 with two-port Expansion
 Cartridge 80
 Port/DN Status
 Device type 165
 overview 163
 procedures 164
 State 166
 Version Number 166
 Ports
 Connectivity test 177
 Power bar
 110 V Installation 66
 with 4 or more modules 66
 Prime line
 on DID trunks 9
 on E & M trunks 7
 on Loop Start trunks 5
 programming 138
 Prime Telephone
 misdialed 216
 misdialed calls 222

- programming 133
 - Privacy
 - on target lines 16
 - programming 133
 - Private lines 131, 136
 - Private network 22
 - Programming
 - Alarm telephone 145
 - Answer mode 127
 - Answer with DISA 128
 - Auto DN 145
 - Auxiliary ringer 133
 - Background music 143
 - Camp timeout delay 141
 - CAP 146'
 - copying data 155
 - Delay Ring 140
 - Dial mode 129
 - Direct-dial digit 144
 - Directed pickup 141
 - DISA DN 144, 145, 146
 - E & M trunk
 - Signal setting 129
 - Full Autohold 130
 - Held Line Reminder 139
 - delay 139
 - Host delay 148
 - Intercom buttons 137
 - Line Access1 34
 - Line pool access 137
 - Line pool access code 149
 - Link time 146
 - music on hold 142
 - On hold 142
 - OSI 148
 - Park prefix 140
 - Park timeout 141
 - Prime line 138
 - Prime telephone 133
 - Privacy 133
 - Received number 130
 - Received number length 154
 - ringing 136
 - saving changes 111, 160
 - Signal type 128, 129, 130
 - System Data 151
 - tools 110
 - Transfer Callback delay 140
 - Transfer delay 140
 - Trunk Data 125
 - Trunk mode 127
 - Trunk type 126
 - using display buttons 115
 - Programming Record 110
 - Public line 131
 - Public network 2, 3, 18
 - Pulse signaling
 - programming 129
-
- ## R
-
- Radiated emissions 72
 - Radio frequency interference 29
 - Real Time Processor 161, 196
 - Recall tone
 - Cadence 75
 - Received number 130
 - length 130
 - changing 153
 - Mismatching 216, 222
 - programming 130
 - uniqueness 130
 - Relay contacts 65
 - Remote access 122
 - busy tone 223
 - cos 10
 - getting wrong tone 227
 - dialing fillters 10
 - DISA 12, 226
-

-
- getting wrong tone 226
 - misdialed calls 222
 - not getting through 224
 - Remote features
 - getting wrong tone 229
 - Security 10
 - troubleshooting 223
 - Remote Access Packages
 - programming 152,154
 - Remote feature access
 - Link time 146
 - Remote feature code
 - no response to 219
 - Remote filters 11
 - Repair
 - addresses 74
 - Replacing a device 163
 - Reset memory 96
 - Resonance 77
 - Restricted call 220
 - Result Codes 179
 - Ring back tone
 - Cadence 75
 - Ring splash
 - Cadence 75
 - Ringer (See Auxiliary Ringer)
 - Ringing 136
 - Electrical load required 72
 - RJ-21 interface 51
 - RJ-21/CA-21** Interface
 - Wiring chart 83
 - RJ2HX/CA2HA** Interface
 - wiring charts 89
- S**
-
- SAPS 30
 - Security 2, 10
 - cos 10
 - Dialing filters 10
 - Service Modes
 - defaults 106
 - on target lines 16
 - Set abilities
 - defaults 104
 - Set Copy 155
 - Set filters 10
 - Set Profile
 - troubleshooting a network 199
 - Shock fragility 77
 - Signal
 - programming 128, 129, 130
 - Software Cartridge 41
 - Software incompatibility 161
 - Specifications
 - Environmental 76, 77
 - Loop power 76
 - Speed dial
 - Cannot be programmed 221
 - defaults 102
 - Startup
 - access code 95
 - Station. Module
 - disabling 172
 - Enabling 175
 - Hanging on mounting brackets 35
 - Internal lines
 - wiring chart 85
 - number required 36
 - Physical dimensions 37
 - Status 170
 - troubleshooting 210
 - Status
 - Module 170
 - Port/DN** 163
 - System Administration Log
 - 190,198
 - Erasing 184
-

- overview 183
- procedures 183
- time of occurrence 184
- 'System Administration Log
 - Alarm 184
- System Data 151
 - copying 155
 - defaults 101
- System Processor (SP) 161, 196
- System Speed Dial
 - defaults 102
- System Test Log 190
 - Alarms 181
 - erasing 182
 - overview 180
 - procedures 180
 - time of occurrence 181
- System Version
 - procedures 162

T

- Target lines 1, 117, 121
 - as Prime line 138
 - definition 4
 - line numbers 117
 - on non-expanded systems 153
 - reaching **DISA** instead 222
 - reaching **Norstar** instead 223
 - received number 130
 - troubleshooting 222
- Telephone
 - Alarm 145
 - changing DN 69
 - disabling 167
 - display unreadable 208
 - enabling 169
 - installation 55

- moving 68
- no dial tone 214
- prime 133
- replacing 68
- state 166
- technical specifications 76
- troubleshooting 207
- User Cards 110
- Version Number 166
- wall-mounted 56
- Temperature 29
- Templates
 - changing 96
- Test 100 (See Connectivity test)
- Tie lines 1, 19
- Tones
 - cadences 75
 - On Hold 142
- Transfer Callback delay 140
- Transporting a system 78
- Troubleshooting
 - **Line 199
 - **Set 199
 - Alarm codes 185
 - Auxiliary ringer 235
 - CII 236
 - Connectivity test result code 179
 - Diagnostics 176
 - Event messages 190
 - Expansion Cartridge 205
 - Feature Cartridge 204
 - Features 202
 - Hung lines 215
 - KSU 204
 - Module Status 170
 - Music 221
 - no dial tone 214
 - Optional Equipment 202

-
- Paging 237
 - Port/DN Status 163
 - Station Module 210
 - System Administration Log 183
 - System Test Log 180
 - Telephone 207
 - Trunk Cartridge 205
 - Trunk Module 209
 - Trunk Cartridges
 - DID** 1
 - disabling 167
 - E & M 1
 - Loop start 1
 - number required 36
 - troubleshooting 205
 - Trunk data
 - copying 124
 - programming 125
 - Trunk Module
 - disabling 172
 - enabling 175
 - hanging on mounting brackets 35
 - number required 36
 - physical dimensions 37
 - Status 170
 - troubleshooting 209
 - Trunk type 126
 - programming options 126
 - Trunks
 - Auto-answer 4, 118
 - definition 4
 - DID 8, 120
 - E & M** 5, 120
 - line numbers 117
 - Loop Start 5, 119
 - manual-answer 118
-
- ## U
-
- Upgrading software 46
 - User Administration data
 - copying 155
-
- ## V
-
- Version number 166
 - Voltages
 - on E & M leads 225
-
- ## W
-
- Wink Start 128, 129, 130
 - Wiring
 - Auxiliary ringer 63
 - Charts 82
 - Wiring chart
 - KSU**
 - internal lines 84
 - Station Module Internal lines 85
 - Trunk Module with DID
 - Trunk 93
 - Trunk Module with **E & M/DISA** Trunk 89
 - Wiring requirements 30
-

norstar

| o a o o o o a o o a

Modular DR5
System Coordinator Guide

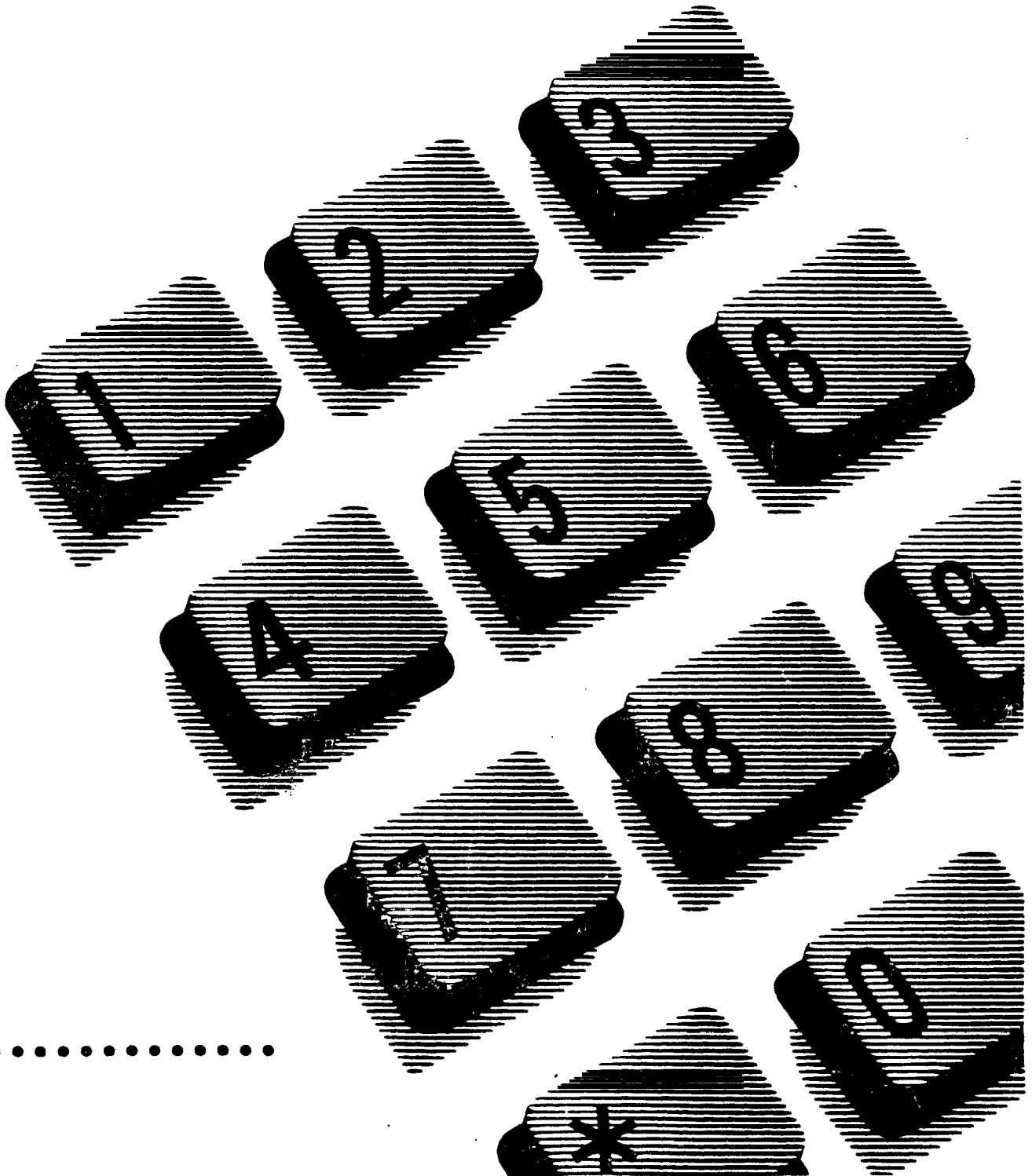

Contents

Welcome to Norstar	1
System Coordinators role	1
Assisting your co-workers	2
Your Service Representative	2
Enhanced Transfer	2
Call Display services	3
Call Display Information	3
Call Log	6
Message Waiting	11
<hr/>	
Programming	13
How to do programming	13
Reviewing programmed settings	13
Planning	14
Programming tools	15
Administration overview	16
Administration headings	16
Entering Administration	18
Exiting Administration	18
Moving through Administration	19
Using the Overlay	20
The Nor-star display buttons	21
Programming details	22
System Speed Dial	24
Names	28
Time and date	31
Direct-Dial	34
Capabilities	35
Dialing Filters	35
Remote access packages	39
Telephone (Set) abilities	40
Line abilities	47
Class of Service (COS) passwords	48
Service Modes	51
Password	55
Log Defaults	56

Call Services	58
Auto Call info	58
Telephone (Set) Services	59
Voice Message Center telephone numbers	60
Voice Message Center lines	60
Copying settings	61
Line programming	61
Telephone programmin	61
Capabilities programming	61
Set Profile and Line Profile	62
Programming you can review	63
Using Set Profile	65
Using Line Profile	66
Programming reminders	67
Norstar telephones	68
Prime telephones	69
Central Answering Position	69
Page zones	70
Line Pools	70
Miscellaneous programming	70
Call Pickup Groups	71
Service Modes	72

Telephone features	73
Using Norstar features	74
Answering the telephone	77
Related features	78
What line indicators mean	79
Rings you may hear	79
Displays	80
Prime telephone displays	82
Autodial	85
Displays	85
Call Forward	88
Related features	88
Displays	89
Call Information	91
Related features	92
Displays	92

Call Log	93
Related features	98
Displays	98
Call Park	102
Displays	102
Call Pickup	104
Displays	104
Call Queuing	107
Camp On	108
Related features	108
Displays	108
Conference	110
Related features	112
Displays	112
COS Password	115
Displays	115
Customizing your telephone	116
Related features	122
Dialing	123
Related features	124
Displays	125
Do Not Disturb	128
Displays	128
Feature Programming	129
Displays	130
Group Listen	132
Displays	132
Handsfree/Mute	133
Hold	135
Host System Signaling	137
Host system signaling codes	137
Displays	139
Line Pools	140
Displays	140
Line Redirection	142
Related features	142
Displays while redirecting lines	142
Displays while canceling redirection	145
Long Tones	147
Displays	147

Messages	148
Related features	150
Displays	150
Norstar Telephones	154
Buttons	154
Headset	156
Hearing Aid Compatibility	157
Wall Mounting	157
Page	158
Related features	158
Displays	158
Priority Call	160
Displays	160
Service Modes	162
Displays	162
Special Telephones	164
Speed Dial	168
Displays	169
System features	172
System Speed Dial	176
Time features	177
Displays	177
Transfer	178
Displays	179
Using Norstar remotely	182
Examples	182
Accessing Norstar remotely	182
Using Norstar remotely	183
Tones you may hear	184
Controlling access to your Norstar system	185
Voice Call	187
Displays	188
<hr/>	
User cards	189
<hr/>	
G l o s s a r y	215
<hr/>	
Index	235

Welcome to Norstar

In addition to basic telephone service, your Norstar digital key system has many extra features that will greatly improve your office communications.

Please take the time to read this guide. It will help you to learn the various tasks which a System Coordinator should perform. This guide also serves as a reference when you assist co-workers to become familiar with Norstar features.

When a telephone system is first installed, it takes a bit of time to settle into using new equipment. **Norstar** minimizes this orientation by providing straightforward features and simple instructions.

System Coordinator's role

The System Coordinator plays an important role in customizing **Norstar** to suit the organization and updating information as the office grows and changes.

Norstar can be customized at three levels:

Personal programming

Personal programming is done by individual telephone users who wish to personalize their **Norstar** telephones by programming features and telephone numbers onto specific memory buttons.

Administration programming

Administration programming is done by the System Coordinator, when you want to change various system-wide settings, as well as some specific settings for each line or telephone.

Configuration programming

Configuration programming is usually done for you by the Installer or Service Representative when **Norstar** is being installed. Specific system-wide parameters are set up in Configuration.

Assisting your co-workers

It is human nature to ask someone how to do something rather than read a user guide. The System Coordinator may be asked to demonstrate to co-workers how to select and use **Norstar** features. To help you prepare for that possibility:

- Familiarize yourself with the procedures for using **Norstar** features. Examine the components of your **Norstar** system, identifying the buttons on the different types of **Norstar** telephones. Read the Telephone User Cards chapter of this Guide for more information on each telephone.
- Familiarize yourself with the various programming reminders provided at the end of the Programming chapter of this Guide. Distribute copies of these reminders to your co-workers after filling in information such as System Speed Dial numbers and names.

It is important for everyone in the office to know that you are the System Coordinator and to know when you are available for consultation. You may wish to schedule sessions for small groups or provide individual assistance to co-workers for programming features on their **Norstar** telephones.

Your Service Representative

Ask your Service Representative for the service department's telephone number, and write it down. If you have problems with your **Norstar** equipment, telephone your Service Representative. If you have problems with programming or using any of the features, first read the appropriate section of this Guide and try again before calling your Service Representative.

Enhanced Transfer

There is a new procedure for using the Transfer feature in this system. If you are upgrading a **Norstar** Modular system, be sure to familiarize yourself with the new procedure.

Call Display services

Most public telephone companies offer Call Display services which provide information about an incoming call. The caller's name, telephone number and in some cases, long distance indication, can be shown on a telephone with a display. Your Norstar DR5 system allows you to:

- view incoming call information as well as the **Norstar** line name that receives the call,
- keep a log of incoming call information and,
- view an integrated display that appears when you have received a message from either an internal **Norstar** user or a Voice Mail message from an external caller.

Note: You can access Call Display information only if you subscribe to the services offered by your public telephone company, and if you have the appropriate hardware installed. Contact your Service Representative for more information.

Call Display Information

Call Display information may be shown on your telephone display when you answer an incoming call. In addition to the caller's name, telephone number and long distance indicator, if available, your **Norstar** system can display the line name that received the call.

In the case where several users share a line, only one telephone can be designated to automatically receive Call Display information when a call is alerting on that line. If the call is transferred or camped to another telephone, the Call Display information is automatically available to that telephone.

If a line is not administered to automatically deliver Call Display information to a telephone, the user can invoke the Call Information feature (see Telephone Features section) or answer the call to view the information.

4 / Call Display services

Depending on your requirements, Call Display information presents several convenient options.

- When a caller is identified before the call is answered, you can answer using a personal greeting. You can also prepare yourself prior to answering the call by retrieving any relevant documents, or otherwise orienting yourself to the expected discussion.
- The Long Distance indicator alerts you that an incoming call is long distance and may therefore have higher priority.
- If you are unable to immediately attend to an incoming call, you can use the calling information to make a quick note.
- You can shorten the interruption time of a call from a recognized person. For instance, you can quickly answer the call and let the party know that you are busy but will return the call soon.
- A telephone can be programmed to first view either the caller's name or number or line name. For example, an attendant might wish to see the calling number and area code first in order to transfer the call according to sales region. The salesperson's telephone could display the caller's name first so they can answer with a personal greeting.

- Call Display information allows you to answer calls on a priority basis. For example:
 - If several calls are alerting at your telephone at the same time, you can request information about the calls to decide which one may be more important.
 - If you are already on a call, information about a second call starting to alert at your telephone can help you to decide whether to answer the second call or remain connected to the first call.
 - If you are in a meeting, the information associated with an incoming call can help you determine if the call is important enough to interrupt the meeting.
 - If you have several calls on hold and wish to identify the callers, you can view the Call Display information associated with each of the calls to help you determine which one you will respond to first.

Programming tips

In order for the designated telephone to automatically receive Call Display information, it must be programmed to ring for incoming calls on that line.

Before programming Call Display information you may wish to consider the following:

- which individual would benefit the most from automatically receiving Call Display information on an alerting line?
- how are calls routed and what information is the most important to know before a call is answered? For instance, if certain lines are private to individuals, an attendant might wish to first view the line name to determine who the incoming call is for.

Call Log

The Norstar Call Log feature uses incoming Call Display information to make a record of call details for follow-up. Call Log also records several other useful facts such as the time and date of the log entry, the number of repeated calls by the same caller and which telephone answered the call if it was subsequently rerouted and handled by someone else in the Norstar system.

When the volume of incoming calls exceeds the ability of employees to handle all calls, or when staff are unavailable to answer calls, Call Log provides a convenient means of capturing information about missed calls.

When connected to a call that has Call Display information, the Logit feature of Call Log can be used to provide a quick and accurate means of recording the caller's information for future use (see Telephone Features for more information).

Programming tips

Call Log space can be assigned to individual telephones according to how much space you wish to allocate to each user. You can also assign all or most Call Log space to a central answering position. For example:

In order to maximize the value of Call Logs and avoid confusion for the end user and their customers, it is important to consider the following when configuring Call Log:

#1 Application of Call Log

Does the user want to return customer calls, track the numbers of calls unanswered, keep a record of most commonly called numbers, etc.?

#2 Who is most interested in logging calls on a particular line?

For instance, dentists working in a clinic may have an individual line assigned to them but prefer that the receptionist handle all of the calls logged on their line.

We strongly recommend that you limit the number of users logging calls for the same line, as this would be confusing. For example, if two users are logging calls for the same line, they do not know who the call was originally intended for nor are both Call Logs updated when one of the users returns a customer's call. Potentially a customer could be called back twice.

There are few situations where the same call needs to be logged at more than one set.

Recommended configuration 1

The Central Answering Position (CAP) has all lines appearing at the CAP set. Incoming calls are first answered on the CAP set and then transferred to the required destination.

The Attendant wants to track all calls unanswered on the system, during working hours and after hours. The users want to capture in their Call Log, any calls which they did not answer at their set and be able to return those calls from the log.

The CAP position logs **No one** answered on all lines and the users log calls **Unanswered by me**. In this configuration the user will log calls transferred to them via intercom (I/C) from the attendant or another user, even though the administration setting is (**Logging Set: N**). Thus the entries in their Call Log are specifically meant for them.

8 / Call Display services

Call Logs with a Central Answering Position

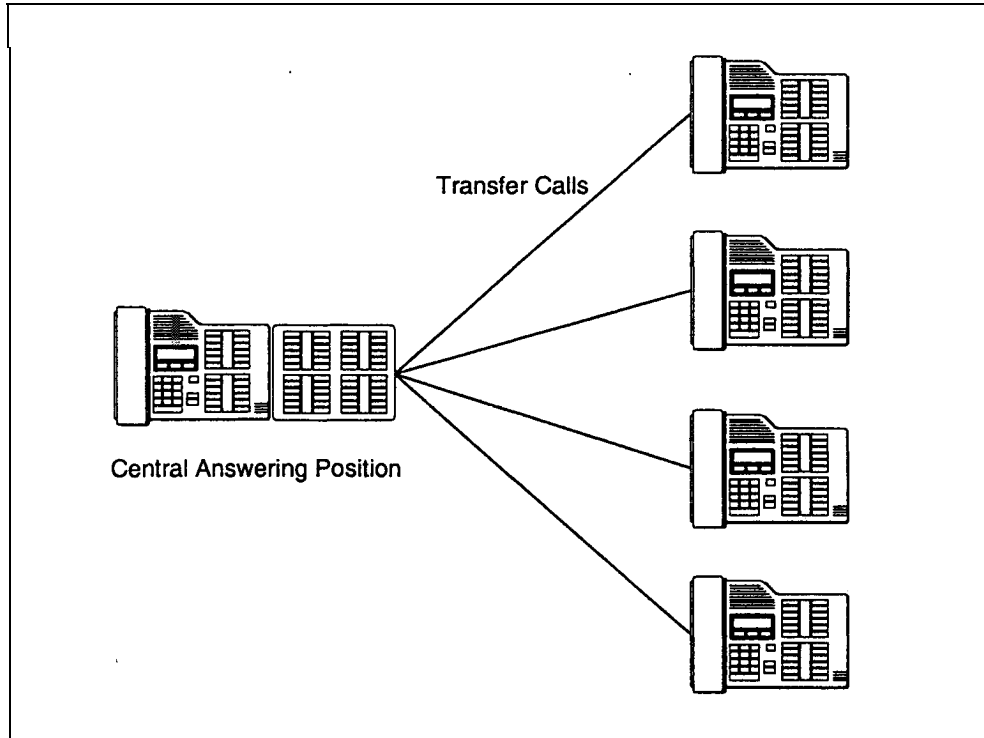

Programming:

CAP Position

Configuration:

Line Access

Line Assignment
(all lines to appear
at the CAP)

Ringing

Administration:

Log Defaults

Space/Log: (assign log space
to all sets for example, 25.)

Set Services

Logging Set: Y

Set Programming:

[Feature] q 8 4 (No one answered)

Set Users

Administration:

Set Services

Logging Set: N (no lines assigned)

Set Programming:

Feature * 8 4 (Unanswered by me)

Recommended configuration 2

Each **Norstar** user has a unique line appearing at their set. The users have a variety of requirements in terms of logging calls. Using * the users can program logging capabilities specifically for their sets.

Call Logs with dedicated lines

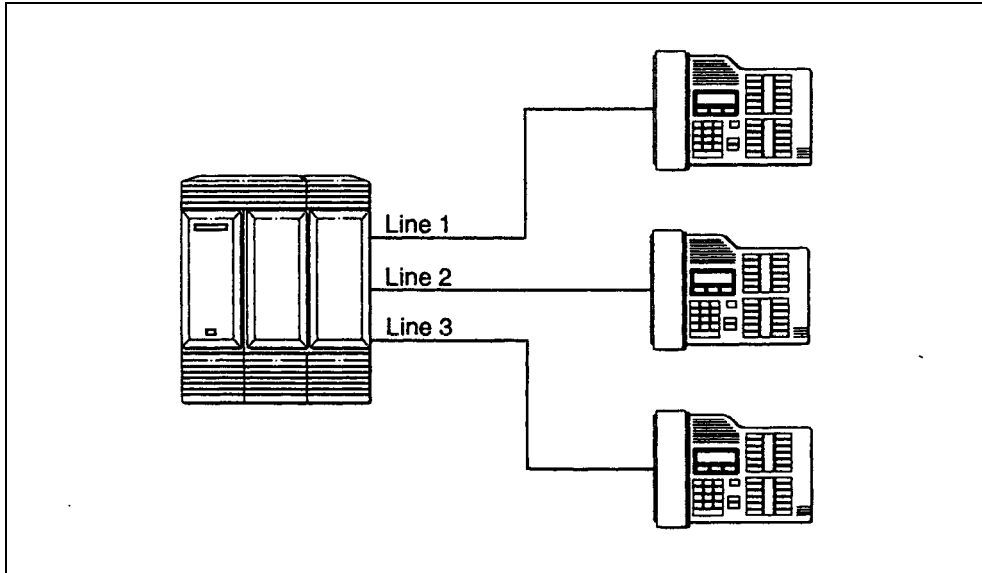

Programming:

Configuration:

Line Access
Line Assignment
Ringing

Administration:

Log Defaults
Space/Log: #
Set Services
Logging Set: Y

Set Programming:

*

(No one **answered**, Unanswered **by** me, Lo9 all Calls, No **auto logging**).

Recommended configuration 3

The Norstar system has lines 1 and 2 appearing on all sets. The supervisor wants to log all calls for lines 1 and 2 at his/her set in order to analyze call traffic. Two users have been selected to return unanswered customer calls. To avoid confusion when logging and sharing lines, one user logs **No one** answered calls on line 1 and a second user logs **No one** answered calls on line 2. This clearly identifies who is responsible for returning calls for each line and ensures that only one person calls the customer back.

Call Logs with shared lines

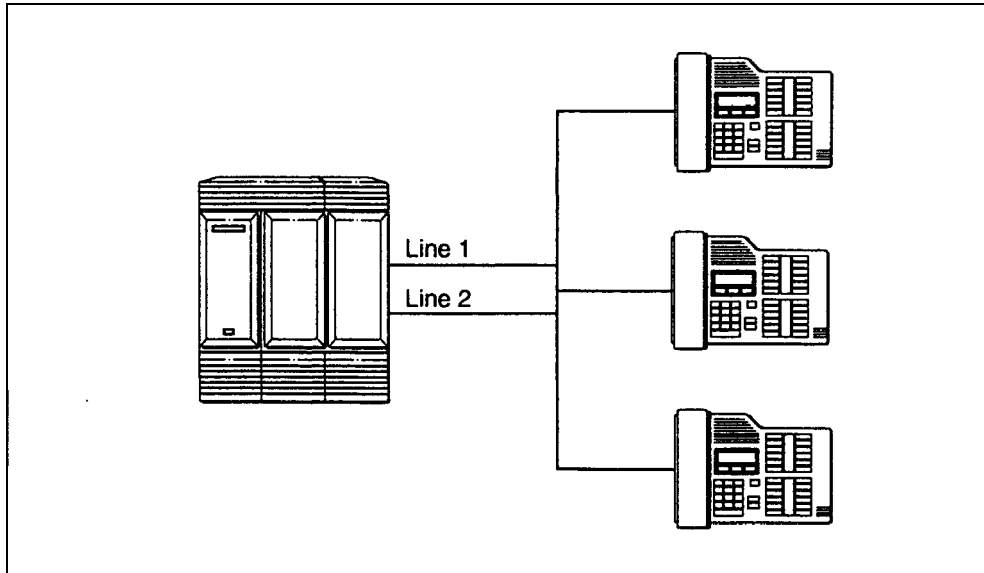

Programming:

Configuration:

Line Access
Line assignment
Ringing

Administration:

Log Defaults

Space/Log: #

Set Services

Show Set: 21 (supervisor's set)

Logging Set:

Lines **001 & 002 Y**

Show **Set: 22**

Logging Set: Line 001 Y

Show Set: 23

Loggings Set: Line 002 Y

Set programming:

Set21 (Feature) [*] 8 4 Los All Call5

Set 22 and 23 [Feature] [*] 8 4 No one answered

Note: For more information, see the Call Log Feature Card.

Message Waiting

Norstar Message feature allows you to send and receive internal messages as well as maintain a record of your messages. If you have subscribed to Voice Mail Messaging (provided by your public telephone company), and visual message waiting indication is defined at your set, Message Waiting also informs you if you have messages at your Voice Message Center and allows you to:

- receive a visual indication that you have messages waiting,
- call your Voice Message Center to hear your messages and,
- clear the message waiting indication from your display.

Programming tips

In order for a telephone to use this feature, it must have a line appearance and Message Waiting must be activated for that line by your public telephone company.

It is possible for two or more telephones to share a line appearance. You must determine if one, some or all of the users sharing a line will receive Message Waiting notification. If it is a sub-group, such as a sales team within a company, it may be appropriate to share the feature providing that the users have an agreed upon procedure for retrieving and deleting messages.

For further information on Call Information, Call Log and Messages, see the Telephone features section. Programming actions are described in further detail in the Programming section.

12-12

Programming

The system comes programmed with default settings that may be sufficient initially. Administration programming is performed by the System Coordinator, and lets you change settings that probably have to be updated regularly because of staff turnover or new business contacts. You can also assign some features to individual lines and telephones. This provides you with real flexibility in making your telephones work together.

This chapter contains detailed procedures for programming System Speed Dial codes, Names for lines and telephones, and Time and Date information. If you are new to Administration programming, you may want to get comfortable with these three procedures before attempting other procedures.

Personal programming does not follow the same procedures as Administration programming. Personal programming allows you to assign a particular function to some of the keys, and is unique to each telephone. For more information on Personal programming, see the Feature programming description in the Telephone features chapter.

How to do programming

The system is programmed using a M7324 or M7310 Telephone. Use the buttons on the telephone to program a setting or to request a specific programming action.

Norstar guides you step by step on the telephone display while you enter programming, select and change what you want, and exit programming.

Reviewing programmed settings

The Set Profile and Line Profile features help you to check your programming by allowing you to review the settings. For more information, see the Telephone features chapter.

Planning

Only one **Norstar** telephone can access Administration programming at a time. While programming a telephone, you cannot use it to make or receive calls. While you are programming, other users of the **Norstar** system may use their telephones, but cannot program any memory keys.

Determine programming requirements

Read about the available programming settings in this chapter, then determine how your co-workers would like the features programmed.

Get the following information:

- the numbers of the installed lines
- the internal telephone numbers of installed **Norstar** telephones
- the telephone numbers to be programmed into System Speed Dial
- the names for lines and telephones
- the lines and internal numbers that are subject to Line abilities and Set abilities programming
- the required Filters and Remote access packages
- the Set Abilities to be assigned to individual telephones
- how the system should be programmed to optimize the Service Modes feature
- whether a new Administration password is required
- whether Class of Service passwords are required.

Programming tools

A **Norstar** telephone

System. programming can only be performed on an M7310 or M7324 Telephone.

The **Norstar** Programming Overlay

The *Norstar Programming Overlay* is a paper cutout that labels telephone buttons used during programming. This makes it easier for you to recognize the button that you want. The *Norstar Programming Overlay* is provided at the end of this book.

Norstar Programming Overlay

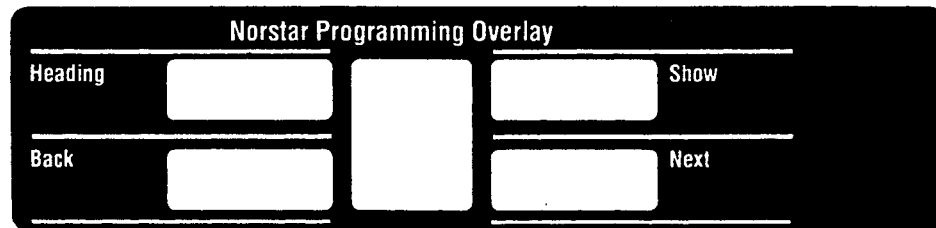

The **Norstar** Modular DR5 Programming Record

The *Norstar Modular DR5 Programming Record* provides a convenient way to record what you have programmed. It also helps you to plan your programming. Settings are grouped according to their function.

Pages from the Record may be photocopied as necessary for programming many telephones or lines.

The **Norstar** Telephone User Cards

Each **Norstar** telephone has a *Norstar Telephone User Card* that lists the most commonly used features.

The **Norstar** Modular DR5 Telephone Feature Card

The *Norstar Modular DR5 Telephone Feature Card* lists the features that can be accessed with the button.

Administration overview

Administration programming lets you change settings for the entire **Norstar** system, as well as settings for individual telephones and external lines.

Pre-programmed default settings may initially be sufficient for your needs. You can use Administration programming to customize your **Norstar** system by changing these default settings. In this section, default options are shown in bold type.

The defaults correspond to those assigned during **Norstar** installation. The option you see while programming may be different if that setting has been changed. If the display shows a line number or internal number during programming, an example is shown in the Administration procedures.

The default **Norstar** internal numbers may vary depending on the installed **Norstar** system. The defaults are:

- two-digit internal numbers (beginning at 21) for non-expanded **Norstar** systems
- three-digit internal numbers (beginning at 221) for expanded **Norstar** systems.

Administration headings

Headings and subheadings in Administration programming help you to keep track of where you are. An example of a heading is **1. Sys speed** dial for programming System Speed Dial. When you program a System Speed Dial number, **Display digits** is displayed as a subheading.

Administration programming has nine headings:

ADMINISTRATION CODE



Password:



1. Sys speed dial



2. Names



3. Time and date



4. Direct-Dial



5. Capabilities



6. Service Modes



7. Password



(8. Los Defaults



9. Call Services

System Speed Dial assigns a two-digit code (01-70) for fast dialing of up to 70 telephone numbers from any **Norstar** telephone.

Names identifies external lines and telephones by name.

Time and Date adjusts the time and date displayed on each **Norstar** telephone.

Direct-Dial designates the telephones that can be reached by dialing a single digit.

Capabilities defines dialing filters, remote access packages, line abilities and telephone abilities. It assigns restrictions and capabilities to Class of Service (COS) passwords, to telephones, to lines and to line/telephone combinations.

Service Modes controls how the **Norstar** system responds to calls, depending on the time of day.

Password changes the password that controls access to Administration programming.

Log Defaults reallocates the Call Log space for all telephones in the system.

Call Services customizes the use of Call Display information at your telephone.

Entering Administration

When your system is first installed, there is no password stored in the Norstar system. You are not prompted to enter a password as you enter Administration for the first time unless your Customer Service representative has already programmed one for your system.

To Enter Administration:

1. Release all calls on your telephone.
2. Enter the Administration access code:

[Feature]	*	*	2	3	6	4	6
Feature	*	*	A	D	M	I	N

 which is also

Feature	*	*	A	D	M	I	N
---------	---	---	---	---	---	---	---
3. If the display changes to Password: , enter the Administration password. (The password is not shown on the display as you enter it.)

If the password is correct, the display shows **1. Sys speed** dial, and three triangular indicators ► are shown on the vertical display.

If the password is incorrect, the display does not change. Check the password. Press **RETRY** and re-enter the password.

4. Place the *Norstar Programming* Overlay over the buttons pointed to by the three triangular indicators, ►.

Exiting Administration

Norstar stores your changes automatically as soon as you alter any settings; you do not need to “save” your changes.

1. Press

Ris

.
 The display briefly shows End of **session**.

Moving through Administration

To program a setting, you must first locate the correct heading. To do this, scan through the headings of Administration using the and (Back] buttons.

To move through Administration headings:
After entering Administration, the display shows **1. Sys speed** dial.

1. Press .
The display shows **2. Names**.
2. Press (Next].
The display shows **3. Time and date**.
3. Press .
The display shows **4. Direct-Dial**.
4. Press .
The display shows **5. Capabilities**.
5. Press .
The display shows **6. Service Modes**.
6. Press .
The display shows **7. Password**.
7. Press (Next].
The display shows **8. Lo9 Defaults**.
8. Press .
The display shows **9. Call Services**.
9. Press .
The display shows **1. Sys speed** dial.

Using the Overlay

The indicators show which buttons can be used at that programming step.. The functions on these buttons allow you to move through the headings and subheadings of Norstar programming.

Heading

moves up in the hierarchy of headings and subheadings.

Show

moves down in the hierarchy of headings and subheadings, or to begin programming settings under a heading or subheading.

Next

moves to the next heading, subheading, or programmable setting.

Back

moves to the previous heading, subheading, or programmable setting.

The Norstar Programming Overlay is located inside the back cover of this Guide.

M7310 Telephone with a **Norstar** Programming Overlay

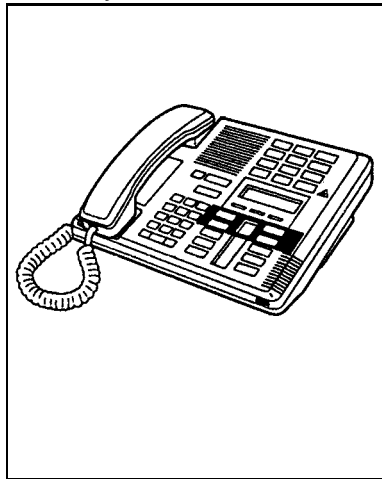

M7324 Telephone with a **Norstar** Programming Overlay

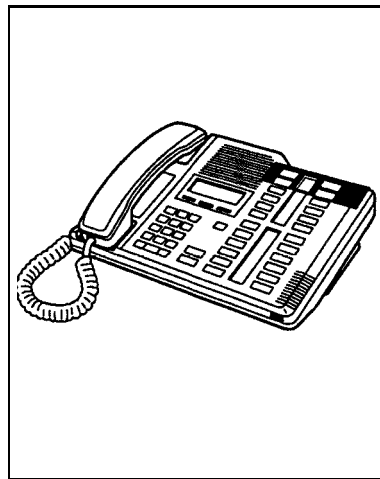

The Norstar display buttons

Display buttons perform many functions. Depending on where you are in programming, one, two, or three display buttons may be available at any one time. Press one of the display buttons to select the function that you want.

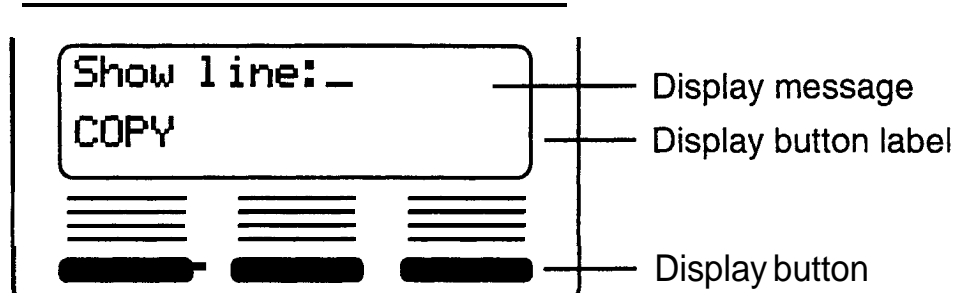

The most common display button labels are:

<u>CHANGE</u>	changes a programmable setting.
<u>BKSP</u>	moves the cursor one space backward (backspace) and delete a character, allowing you to re-enter a number or letter.
<u>COPY</u>	copies line or telephone programming.
<u>VIEW→</u>	shows the last part of a displayed message longer than 16 characters.
<u>←VIEW</u>	shows the first part of a displayed message longer than 16 characters.
<u>--></u>	moves the cursor one position to the right when programming a name.
<u><--</u>	moves the cursor one position to the left when programming a name.

Programming details

Entering numbers

Numbers are entered from the Norstar telephone dial pad. The **BKSP** display button may be used to edit the number.

Line numbers must always be entered as a three-digit number. Line numbers from 10 to 99 must be entered with a leading zero (line 020, for example). Similarly, line numbers less than 10 must be entered with two leading zeros (line 002, for example).

Internal telephone numbers, also referred to as Directory Numbers (DNs), can be two- to seven-digits long on a non-expanded system, and three- to seven-digits long on an expanded system. The default DN length is two on a non-expanded system and three on an expanded system. The DN length can be changed by your Customer Service representative.

Viewing long telephone numbers

External telephone numbers can be up to 24 digits, but the telephone display is only 16 character spaces long. If you wish to see a previously programmed number that is longer than 16 digits, you must do the following:

Begin, for example, with **123456789012345...**

The display shows only the first 15 digits. The three dots (...) at the end of the display indicate that more digits remain to be displayed for the external number.

1. To see the remaining digits, press **VIEW**.
2. To see the first 15 digits again, press **←VIEW**.

Entering names

Letters and numbers can be entered as part of a name for various settings. The method of entering a name is always the same.

Begin with a setting that prompts you to enter a name. The display shows a cursor (**_**) to indicate where you can enter the next character. To enter a name:

- 1 . Press the button on the dial pad with the printed letter or number that you want.

Each time that you press the button, a new character is shown on the display. For example, the button for the number 3 has the letters D, E, and F, where:

D is shown after the first press

E is shown after the second press

F is shown after the third press

3 is shown after the fourth press

D is shown again after the fifth press.

(Letters are always shown in upper case.)

2. When the character that you want is displayed, press **-->** or **#** to move the cursor to the next character position.

OR

If you want to correct a character entered by mistake, press **<--** or ***** until the cursor is positioned beneath the character that you want to correct.

OR

If you want to move the cursor back and delete a character, press **BKSP**.

3. Repeat step 1 for the remaining characters.

System Speed Dial

The System Speed Dial programming section allows you to set the Speed Dial codes for external telephone numbers which the people in your office use most often. Use the Personal Speed Dial feature to program numbers used by only one or two people.

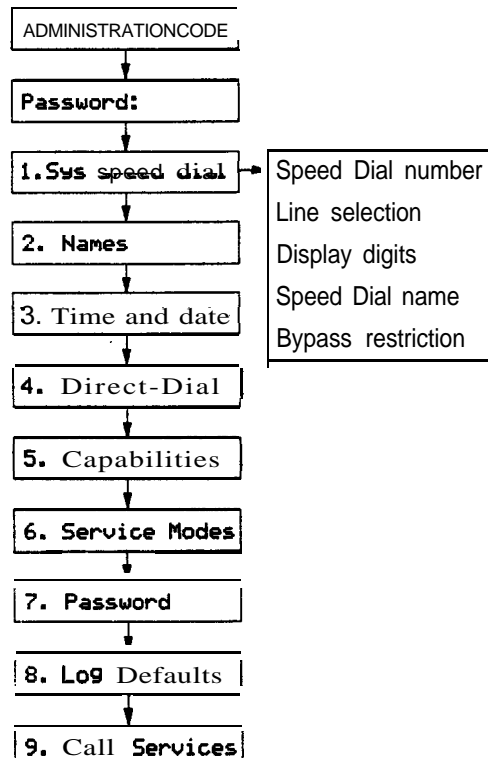

You can program 70 System Speed Dial codes ranging from #01 to #70.

System Speed Dial Number

System Speed Dial Number lets you assign a System Speed Dial telephone number to a two-digit code. The System Speed Dial Number may contain 24 digits.

Begin with the display showing 1. **Sys speed** dial .

1. Press .
The display shows **Speed dial #: ...**
2. Select the Speed Dial code you want to program:
Press display shows the correct code.
OR
Enter the Speed Dial code on the dial pad.
3. Press .
Note: To assign default settings, press **DEFAULT** and then press to go to the next Speed Dial code.
4. Press **CHANGE**.
For example, the display may show **#05: ...**
5. Enter the new telephone number from the dial pad , including all digits such as an initial or an area code that must be dialed to call the number manually. If you need to backspace the cursor, press the **BKSP** display button.
For example, press ().
The display shows 5551234,.
6. Press **OK** to store the System Speed Dial number.

Programming hints

A Host System Signaling feature code may be inserted into the System Speed Dial number. Pause and Run/Stop each use one character position; and Link, Timed Release, and Programmed Release each use two positions.

For more information on using the features in System Speed Dial programming, see the Host System Signaling section in Telephone features.

Line Selection

Line Selection allows you to specify the external line that is used for a System Speed Dial number. The options are the Prime line, an external line, or a line pool.

After you have programmed a System Speed Dial number, press **Next** and the display shows:

Use Prime 1 line

OR

Use 1 line: 882, for example, if a line is already assigned

OR

Pool code: 42, for example, if a line pool access code is already assigned.

1. To change the setting, press **CHANGE** until the display shows the option to be programmed.
2. If you select a line number or a line pool access code, enter the digits from the dial pad. A line pool access code can be from one to four digits long.

Display Digits

Display Digits determines whether the telephone number is displayed when a System Speed Dial number is used, or whether a name associated with that number is displayed.

After you have programmed a line selection for a System Speed Dial number, press **Next** and the display shows

Display digits: Y.

1. Press **CHANGE** to change the setting. Options are Y (Yes) and N (No).

System Speed Dial Name

System Speed Dial Name allows you to assign a name to the stored System Speed Dial number. When the Display Digits setting is “No”, the programmed name is shown on the Norstar display when the System Speed Dial feature is used.

The name can be up to 16 characters long. The default name is the System Speed Dial number; for example, **Sys Spd Dial 02** for System Speed Dial code 02.

After programming Display Digits to “No”, press and the display shows Name.

1. Press .
The display shows the assigned or default name.
2. Press **CHANGE**.
3. Enter the first character of the name by pressing the appropriate dial pad button one, two, three, or four times. For more information, see the section in this chapter entitled Entering names.
4. To move the cursor to the next position, press **-->**.
Continue entering characters.

Programming hints

You can program System Speed Dial Name only if Display Digits is set to No.

Bypass Restrictions

Bypass Restrictions allows the System Speed Dial number to bypass any restrictions in applied Dialing filters. Dialing filters are programmed in the Capabilities section of Administration programming.

After programming the System Speed Dial Name, press and the display shows **BYPASS restr'n: N**.

1. Press **CHANGE** to change the setting. Options are N (No), and Y (Yes).

Names

You can assign names to identify external lines, target lines and your co-workers' telephones. During a call, the name (if programmed) is shown on the telephone display instead of the external line number or internal telephone number of the caller.

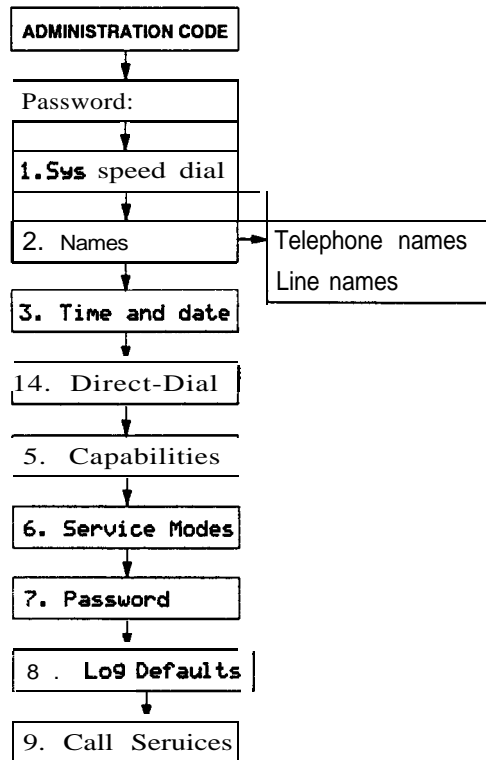

Programming hints

Telephone names and line names can contain both letters and numbers, but cannot be longer than seven characters. The # and * symbols cannot be used.

You can give the same name to two or more telephones, or to a telephone and a line in your system. To avoid confusion, you should avoid such duplication. Use initials, abbreviations, or even nicknames to give each telephone a unique name.

Two lines cannot have the same name. If you enter a line name which has already been used, you hear an error tone, and the display shows Use unique name.

Telephone Names

Personalize your office communication by assigning names to the telephones in the Norstar system. A telephone's default name is its internal number, for example, 227.

Begin with the display showing 1. **Sys speed** dial.

1. Press [Next].

The display shows 2. Names.

2. Press (Show] twice.

The display shows Show **set: _**.

3. Enter the internal number of the telephone.

OR

Press for the name of the telephone with the first internal number.

4. Press CHRNQE.

The name is removed from the display, and a cursor is shown.

5. Enter the first character of the name by pressing the appropriate dial pad button one, two, three, or four times. For more information, see the section in this chapter entitled Entering names.

Note: Press to restore the default name and go to the next internal number.

6. Press --> to move the cursor to the next position.

Continue entering characters.

Programming hints

If Automatic Telephone Relocation is turned ON, the name and internal number of a telephone are saved if the telephone is moved within your system.

Line Names

Line Names allows you to assign a name to an external line. The default name is the line number, for example, **Line002**.

Begin with the display showing **1. Sys speed dial** .

1. Press .
The display shows **2. Names**.
2. Press .
The display shows **Set names**.
3. Press [Next] .
The display shows **Line names**.
4. Press [Show] .
The display shows **Show 1 line: _**.
5. Enter the line number from the dial pad.
OR
Press [Next] to program the name of line 001.
6. Press **CHANGE** .
The name is removed from the display, and a cursor is shown.
7. Enter the first character of the name by pressing the appropriate dial pad button one, two, three, or four times. For more information, see the section in this chapter entitled Entering names.
Note: Press to restore the default name and go to the next external line.
8. Press **-->** to move the cursor to the next position.
Continue entering characters.

Time and date

Time and date programming allows you to set the time and date which is shown on the display when a telephone is not in use. As with any clock, this needs to be done every time that your office has a power failure.

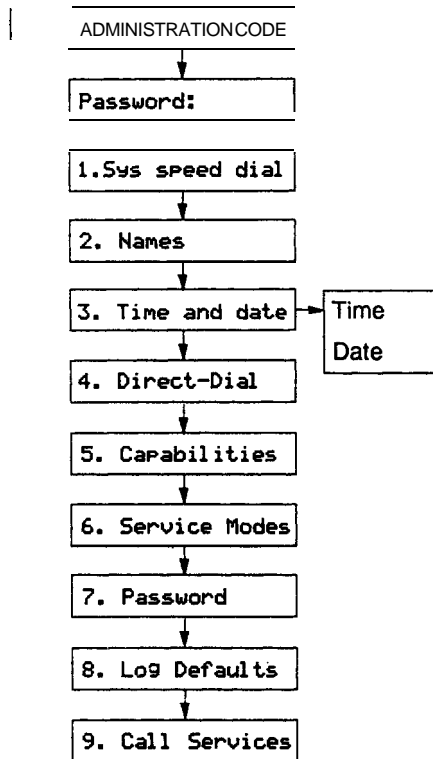

Changing the time and date is easy, but there are a couple of things to remember:

- All times and dates must be entered using numerals. For example, February would be entered as “2”.
- The time may be entered in either 12 or 24-hour format. If the display is in English, and the hour entered is less than thirteen, the display prompts you to specify “am” or “pm”.
- The year is not shown on the telephone display, but make sure that it is set correctly. Norstar is programmed to allow for leap years.

English language displays always show the time in 12-hour format, while the alternate language displays always use the 24-hour format.

Setting the time

Begin with the display showing **1. Sys speed** dial .

1. Press twice.
The display shows **3. Time** and date.
2. Press [Show].
The display shows the time, for example, Time **01:00**.
3. Press **CHANGE**.
The display shows the hour, for example, Hour: **01**.
4. Set the hour.
 - a. Press **CHANGE**.
A cursor replaces the number on the display.
 - b. Enter the hour using the dial pad.
For example, press .
 - c. Press .
5. Set the minutes.
 - a. Press **CHANGE**.
A cursor replaces the number on the display.
 - b. Enter the minutes using the dial pad.
For example, press .
 - c. Press .
6. To switch the message to **PM** , press **CHANGE**.
To switch it back to **am** , press **CHANGE** again.

Setting the date

Begin with the display showing 1. **Sys speed** dial.

1. Press [Next] twice.
The display shows 3. Time and date.
2. Press [Show].
The display shows the time, for example, Time 81: **00**.
3. Press .
- The display shows the date, for example, Date 31 Mar 91.
4. Press **CHANGE**. The display shows Year: 88.
5. Set the year.
 - a. Press **CHANGE**.
A cursor replaces the number on the display.
 - b. Enter the year using the dial pad.
For example, press to enter the year 1990.
 - c. Press (Next).
The display shows the month, for example **Month:** 81.
6. Set the month.
 - a. Press **CHANGE**.
A cursor replaces the number on the display.
 - b. Enter the month using the dial pad.
For example, press (2 to enter February).
 - c. Press [Next].
The display shows the day, for example **Dar:** 61.
7. Set the date.
 - a. Press **CHANGE**.
A cursor replaces the number on the display.
 - b. Enter the date using the dial pad.
For example, press .

Direct-Dial

Direct-Dial programming allows you to call the Direct-Dial telephone assigned to your telephone by dialing a single digit. Up to five Direct-Dial telephones can be designated to handle calls from five groups of telephones. Use this Administration heading to specify which telephone directory numbers (DNs) are designated as Direct-Dial telephones.

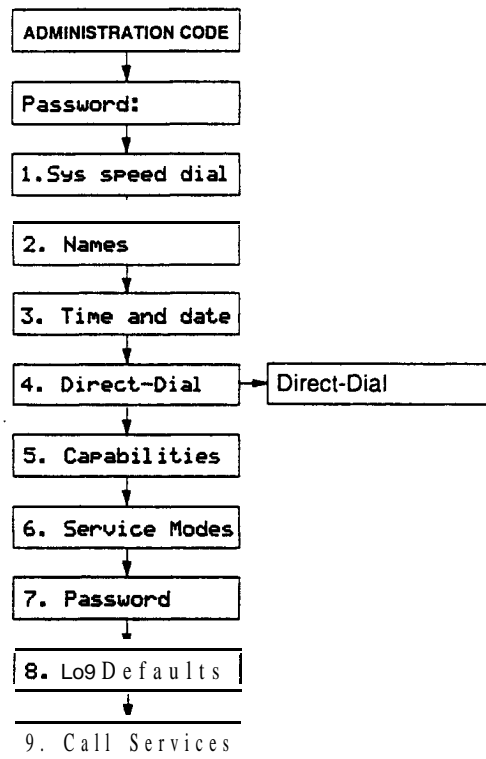

Use the button, the **CHANGE** display button and the dial pad to enter the internal number of the telephone to be designated as the Direct-Dial telephone.

Programming hints

To complete Direct-Dial telephone programming, assign a Direct-Dial telephone to each telephone in the system using the Capabilities section of Administration programming.

The digit you dial in order to get the Direct-Dial telephone to ring can be programmed by your Customer Service representative.

Capabilities

Capabilities programming assigns restrictions, exceptions, and remote access capabilities to Class of Service (COS) passwords, telephones, and lines.

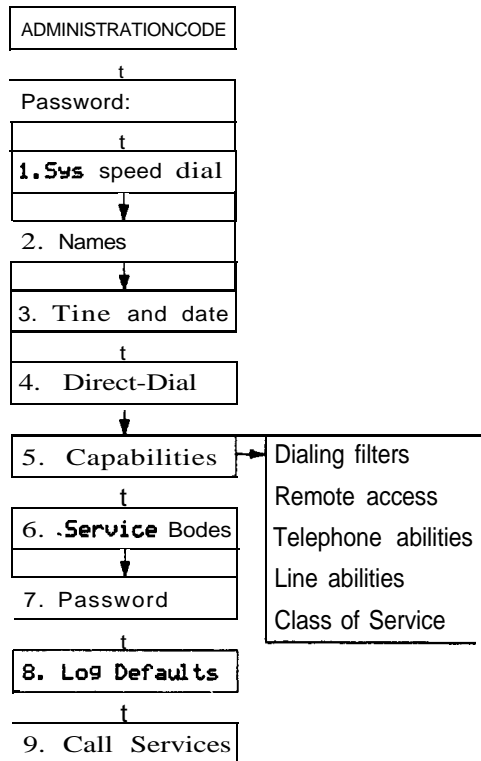

Dialing Filters

A dialing filter is made up of restrictions and exceptions. These specify the external numbers which can or cannot be dialed from a telephone or on a line.

After dialing filters are defined, they may be used as telephone (set) filters, line filters and line/set filters to manage outgoing calls, and as remote filters applied to lines. Remote access packages control the numbers that can be dialed by remote users when they are calling into Norstar to use a Norstar line for placing calls.

Use the button, the **ADD** display button, the dial pad, and the **OK** display button to program the restrictions and exceptions for each dialing filter.

For example

You may need filters for three different, types of users:

- Managers may require unrestricted dialing.
- Secretaries may need to be limited to calls on line 003 to the West coast office only.
- Clerks may need to be limited to calling specific area codes and the West coast office.

Internal users

Dialing filters are most commonly used to prevent unauthorized long-distance calls, without restricting local calls. Dialing filters restrict the numbers that an internal user can dial on external lines.

If a line/set filter has been defined for the line selected at the user's telephone, it overrides any line filters or telephone filters which might otherwise apply.

If no line/set filters have been defined, dialed digits are filtered through (and may be rejected by either of) the telephone filter (if defined) and the line filter (if defined).

External users

For a remote user, who has dialed into **Norstar** on an auto-answer line (or a DID line), and passed through any **DISA** security, there are no restrictions on the numbers the user can dial.

For remote users trying to tandem through the **Norstar** system, the Line filters and Remote filters assigned in Line abilities apply.

For a remote user entering the system through **DISA**, the filters and Remote access packages associated with their **COS** password replace the Remote filter, the Line filter, and the Remote access package assigned to the incoming line.

 Programming hints

- Norstar can have up to 100 dialing filters (00 to 99).
- Filter 00 cannot be changed.
- Each programmable filter can have up to 48 restrictions; there is no limit on the number of exceptions that can be allocated to any restriction.
- There is a maximum of 600 restrictions and exceptions allocated to the 99 programmable filters. For example, notice the reduction in the number of available restrictions and exceptions after each filter has been programmed.

Filter	User type	Rest's	Excep's	Remaining
00	manager	- -	- -	600
01	secretary	5	5	590
02	clerk	7	12	571
Total		12	17	(600 - 12 - 17 = 571)

- The maximum length for a restriction is 15 digits; for an exception, the maximum is 16 digits.
- The asterisk * is a “wild card” that stands for any digit.
- Any restriction or exception can be used in any number of filters. Each time it is used, it counts as one entry. For example, if restriction 411 exists in filters 01, 02 and 03 it uses up three entries of the 600 entries available.
- Removing a restriction also removes the exceptions associated with it, and changes the identifying number of the restriction. For example, removal of restriction 01 renumbers restrictions 01 to 48 as 01 to 47.

Note: The removal of a restriction from one dialing filter has no effect on the contents of other filters into which the restriction was copied.

- You cannot delete a filter. Removing the restrictions programmed on a filter makes it an unrestricted filter but the filter is not removed.

Filter descriptions

- Filter 00 permits unrestricted dialing, and cannot be changed.
- Filter 01 is pre-programmed with five restrictions and some associated exceptions.

Template				
Square, Hybrid, PBX			Centrex	
Filter	Restrict's	Except's	Restrict's	Except's
00	Unrestricted dialing			
01	0		90	
	1	1800 1555 1*1*555 1*0*555	91	91800 91555 91*1*555 91*0*555
	911	911	9911	9911
	411		9411	
	976		9976	
02 - 99	None			

Filters 02, 03, and 04, although not pre-set with restrictions and exceptions, are the default filter settings used later in programming:

Filter	Where the filter is programmed as a default setting in Capabilities programming	
02	Set abilities	Set filter:
03	Line abilities	Line filter:
04	Line abilities	Remote filter:

Remote access packages

Remote access packages allow you to control the remote use of Norstar line pools and the Remote Page feature.

Remote access packages are associated with COS passwords and the auto-answer lines used by remote users.

Remote access packages default template

Parameter	Square	Centrex	Hybrid	PBX
Package 00 †	Prohibits access to line pools and Remote Page. Cannot be changed.			
Package 01				
Line Pool access	Y for Pool A N for Pools B to 0			
Remote Page	No			
Packages 02 - 15				
Line Pool access	N for Pools A to 0			
Remote Page	No			

† Remote package 00 is the default setting for the Remote package setting.

Use the button and the dial pad to select the Remote Access package you want to program. Then, use the **CHANGE** display button to select the line pool access setting: N (No) or Y (Yes).

Note: The Line Pool access display shows an alphabetic line pool identifier, followed by a numeric line pool access code in brackets, for example, Pool **A(9):N**. If no access code has been identified, there is nothing between the brackets, for example **Pool A():N**. The line pool access code can be programmed by your Customer Service representative.

Use the **CHANGE** display button to select the Remote Page setting: N (No) or Y (Yes).

Programming hints

Norstar systems can have up to 16 Remote access packages (00 to 15). The limitations are:

- Package 00 permits no access to line pools or to remote paging. Unlike packages 01 to 15, package 00 cannot be changed.
- For remote users calling into the **Norstar** system to use **Norstar** lines for calling out, the Remote dialing filters and the outgoing Line dialing filters (in **Line abilities**) still apply.

Telephone (Set) abilities

Telephone (Set) abilities programming applies dialing filters and permissions to telephones. Telephone abilities include:

Telephone (set) filters	Auxiliary Ringer
Line/telephone filters	Direct-dial telephones
Telephone Administration Lock	Call Forward On Busy
Full Handsfree	Call Forward No Answer
Automatic Handsfree	Allow Redirect
Handsfree Answerback	Redirect ring
Call Pickup Group	Hotline
Paging	Priority Call
Page zone	

Telephone (Set) filter

A Telephone filter is a collection of restrictions and exceptions defined in Dialing filters. These filters are applied to telephones through Set filter programming.

Telephone filters do not apply to calls dialed out on E&M trunks.

Use the button, the **CHANGE** display button and the dial pad to enter the number of the Dialing filter to be assigned as the Telephone filter. The default telephone filter is 02.

Line/telephone (Line/set) filter

A Line/telephone dialing filter is applied to the appearance of a line at a specific telephone. This type of filter replaces any Line or Telephone filters which might otherwise apply.

Line/set filters control the numbers that may be dialed on specific external lines from specific telephones.

For example, a Line/set filter can permit a call to a specific long-distance number on line 003 from a specific telephone, but no other long-distance numbers, and on no other line.

Use the button, the **CHANGE** display button and the dial pad to enter the number of the Dialing filter to be assigned as the Line/telephone filter.

Programming hints

- Up to 100 filters may be defined in the system (filters 00 to 99). Line/set filters fall under this limitation.
- A maximum of 255 Line/set dialing filters may be applied to lines at telephones.

Telephone Administration Lock

Telephone Administration Lock limits the types of features that may be used or programmed at a telephone. Use the **CHANGE** display button to select one of the three options: None, Partial and Full.

None allows you to access any feature on your telephone.

Partial prevents:

- | programming Autodial buttons
- | programming Personal Speed Dial numbers
- | programming feature buttons
- | moving line buttons
- | changing the display language
- | changing Dialing Modes (Automatic Dial, Pre-Dial, and Standard Dial)
- | using Voice Call Deny
- | using Administration programming
- | saving a number with Saved Number Redial

Full, in addition to the restrictions outlined for Partial lock, prevents:

- | changing Background Music
- | changing Privacy
- | changing Do Not Disturb
- | using Ring Again
- | using Call Forward all calls
- | using Send Message
- | using Trunk Answer
- | activating Service Modes

Full Handsfree

Full Handsfree allows you to make or receive calls without picking up the receiver, and allows a headset to be used with the Norstar telephone. Use the **CHANGE** display button to select the setting: N (No) or Y (Yes).

Programming hints

A **Handsfree** button is automatically assigned to a telephone that is programmed with Full Handsfree. Full Handsfree is always disabled for an **M7100** Telephone.

Automatic Handsfree

Automatic Handsfree activates the Handsfree microphone and speaker when you make or receive calls by pressing a line button. Use the **CHANGE** display button to select the setting: N (No) or Y (Yes).

Programming hints

You can program Automatic Handsfree only if the telephone has Full Handsfree set to Yes.

Handsfree Answerback

Handsfree Answerback allows you to answer a Voice Call without lifting the receiver. Use the **CHANGE** display button to select the setting: Y (Yes) or N (No).

Programming hints

Handsfree Answerback is always disabled for an M7100 Telephone.

Call Pickup (Group)

Each telephone can be assigned to one of up to nine Call Pickup groups. Members of a Call Pickup group can answer any calls ringing at a telephone in the group. Use the **CHANGE** display button to select the setting: NO, 1, 2, 3, 4, 5, 6, 7, 8, or 9.

Programming hints

You cannot pick up a call that is on a Private line, or a call that is ringing only the Auxiliary Ringer.

Paging

This setting determines whether a telephone has access to the Page feature. Use the **CHANGE** display button to select the setting: Y (Yes) or N (No).

Page zone

Each telephone can be assigned to one of six zones for receiving Page messages. A zone is any selection of **Norstar** telephones you want to group together, **regardless** of location. Use the **CHANGE** display button to select the setting: 1, 2, 3, 4, 5, 6, or NO.

Programming hints

You can program Page zone only if the telephone has Paging set to Yes:

Auxiliary Ringer

This setting causes the Auxiliary Ringer (if installed) to ring when the telephone rings. An Auxiliary Ringer is important in noisy environments where a **Norstar** telephone might otherwise not be heard. Use the **CHANGE** display button to select the setting:

N (No) or Y (Yes).

Direct-Dial telephones

A telephone can be assigned to call a Direct-Dial telephone when you dial a single digit. Use the **CHANGE** display button to select the setting: Set1, Set2, Set3, Set4, Set5, and None.

Programming hints

Each telephone can call only one Direct-Dial telephone, although up to five Direct-Dial telephones can be designated in the Direct-Dial section of Administration programming. Any number of telephones can be assigned to call a particular Direct-Dial telephone.

The digit you dial in order to get the Direct-Dial telephone to ring can be programmed by your Customer Service representative.

Call Forward On Busy

Call Forward On Busy redirects an incoming call to another telephone on your **Norstar** system when you are busy on a call, or when you have Do Not Disturb activated at your telephone.

Use the button, the **CHANGE** display button, and the dial pad to program the internal number of the telephone that your calls are to be directed to.

Programming hints

Call Forward on Busy programming is ignored in the following situations:

- If you are busy on a target line call, another call to that target line is redirected to the Prime telephone for the trunk that received the second target line call.
- If Line Redirection is in effect, it takes precedence.

Call Forward No Answer

Call Forward No Answer lets you redirect an incoming call to another telephone on your Norstar system when the call is not answered at your telephone.

Use the button, the **CHANGE** display button, and the dial pad to program the internal number of the telephone that your calls are to be directed to.

Programming hints

Line Redirection takes precedence over Call Forward No Answer.

Forward No Answer delay

If you assign another telephone to receive your calls, you can also assign the number of times that the incoming call rings before the call is forwarded. To estimate the delay time in seconds, multiply the number of rings by six. Use the **CHANGE** display button to select the setting: 2, 3, 4, 6, or 10 rings.

Allow Redirect

Allow Redirect enables you to use the Line Redirection feature. Use the **CHANGE** display button to select the setting: Y (Yes) or N (No).

See the explanation of Line Redirection in the Telephone' Features chapter for more information on redirecting lines.

Redirect ring

The Redirect ring setting causes a telephone to ring briefly (a 200 millisecond burst) when a call is redirected on one of its lines. Each telephone with a ringing appearance of that line also rings briefly for the redirected call if the Redirect ring setting for them is 'Y' (the default). Use the **CHANGE** display button to select the setting: Y (Yes) or N (No).

A user enters the Line Redirection feature code to redirect calls. See the explanation of Line Redirection in the Telephone Features chapter for more information on redirecting lines.

Hotline

Hotline automatically calls a pre-assigned number when you lift the receiver or press at your telephone. Hotline has three options: None, internal (**Intrnl**), and external (**Extrnl**).

Internal assigns an internal number.

External assigns an external number. If you select an external number, you can also select the line on which the call is made: the Prime line, an external line, or a line pool. You will have to specify the Line Pool Access code for a line pool.

Use the **CHANGE** display button to select Hotline setting. If you select **Intrnl**, use the button, the **CHANGE** display button, and the dial pad to program the internal number of the telephone that Hotline calls are to be directed to.

If you select **Extrnl**, use the button, the **CHANGE** display button, and the dial pad to program the external telephone number that Hotline calls are to be directed to, and to program the line Hotline calls are to be made on.

Programming hints

The telephone should be labeled to inform anyone using it that Hotline is active.

A telephone's Prime line, line pool access codes, and access to a line pool can be programmed by your Customer Service representative.

Priority Call

This feature lets you call from your Norstar telephone and interrupt calls or override Do Not Disturb on another Norstar telephone. Use the **CHANGE** display button to select the setting: N (No) or Y (Yes).

Programming hints

Apply this feature only to telephones from which such interruptions can be justified.

Line abilities

Line abilities programming applies dialing filters, remote access dialing filters and remote access packages to lines.

Line filter

A Line filter is a collection of restrictions and exceptions defined in a Dialing filter, and applied to an outgoing line: A Line filter on an outgoing line may be used to limit the capabilities of that line to carry calls made to specific area codes or destinations.

Use the **CHANGE** display button, and the dial pad to program the Line filter. Filter 03 is the default Line filter.

Remote filter

A remote access dialing filter can control dialing on incoming auto-answer trunks used for making tandem calls (that is, calling into Norstar to use one of its lines for placing calls). Employees can be allowed to telephone into a Norstar system on auto-answer lines, and call out on a line designated for long-distance calls to specific area codes.

Use the **CHANGE** display button, and the dial pad to program the Remote filter. Filter 04 is the default Remote filter.

Remote package

Remote access packages control access to line pools and the Remote Page capability, for calls on incoming auto-answer trunks.

Use the **CHANGE** display button, and the dial pad to program the Remote Access package. Package 00 is the default Remote package, which gives no access to line pools or to Remote page.

Class of Service (COS) passwords

Class of Service (COS) passwords permit controlled access to a system's resources by remote users. Class of Service programming defines passwords, their associated dialing filters, user filters and remote-user access packages.

A Class of Service can be associated with a telephone, a line or a COS password. Class of Service determines whether a remote user can or cannot access lines in line pools and remote paging. It also determines the dialing capabilities that apply to outgoing lines from line pools (in the case of remote users), or to internal telephones and any lines used for external calls (in the case of internal users).

The capabilities to which a remote user has access depend on:

- the COS associated with the auto-answer trunk on which the user is calling
- a COS password, if entered.

Depending on the COS in effect, remote users may be able to access all or some of the system's resources available to remote users. Typically, each user has a separate password. Several users can share a password or one user can have several passwords.

Entry of a DISA DN (if one has been programmed) allows a remote user to change the COS applied for the duration of the call.

COS passwords for internal users

Internal users have a Class of Service associated with their telephones, in the sense that there are dialing filters associated with telephones, as well as line pool assignments. Internal use of a COS password affects only the telephone's dialing capabilities.

The ability to change the COS internally means that someone using another person's telephone can temporarily change the restrictions that would normally be applied.

Password security

- Class of Service passwords for a system should be determined randomly, and should be changed on a regular basis.
- System users should memorize their COS passwords instead of writing them down.
- Employees' COS passwords should be deleted when they leave the company.

You can block tandem calls that would use expensive routes by using Class of Service to restrict access to line pools, and you can control the external destinations dialed through the use of dialing filters.

You can use Class of Service to prevent remote access to line pools and remote paging. Remote calls are then limited to target lines in the system.

Groups of users can be restricted, or permitted, to access remote paging through the Class of Service applied to their password.

Programming hints

- A system can have a maximum of 100 six-digit COS passwords (00 to 99).
- You can copy the data from one COS password to another COS password number using the **COPY** display button in the same way that telephone and line data can be copied.
- COS passwords must be unique.

Programming **COS** passwords

Use the **[Show]** button, the **CHANGE** display button, and the dial pad to program the six-digit sequences for each password. Use the **BKSP** display button to edit digit sequences you have entered.

User filter

The COS User filter replaces the telephone (set) filter, the line/set filter or the remote filter, that would otherwise apply to a specific call.

Use the button, the **CHANGE** display button, and the dial pad to program the two-digit User filter. The default setting (**Def1 t**), means that any other filters in place (telephone (set) filter, line/set filter, or remote filter) still apply.

Line filter

The COS Line filter replaces the line filter that would otherwise apply to a specific call.

Use the **CHANGE** display button, and the dial pad to program the two-digit Line filter. The default setting (**Def1 t**), means that any Line filter already programmed still applies.

Remote package

The COS Remote package replaces the Remote Access package that would otherwise apply to a specific call.

Use the **CHANGE** display button, and the dial pad to program the Remote package. The default setting (**Def1 t**), means that any Remote Access package already programmed still applies.

Service Modes

Using Service Modes, you can control how the Norstar system responds to calls, depending on the time of day. Up to three different Service Modes can be programmed, each with unique ringing arrangements.

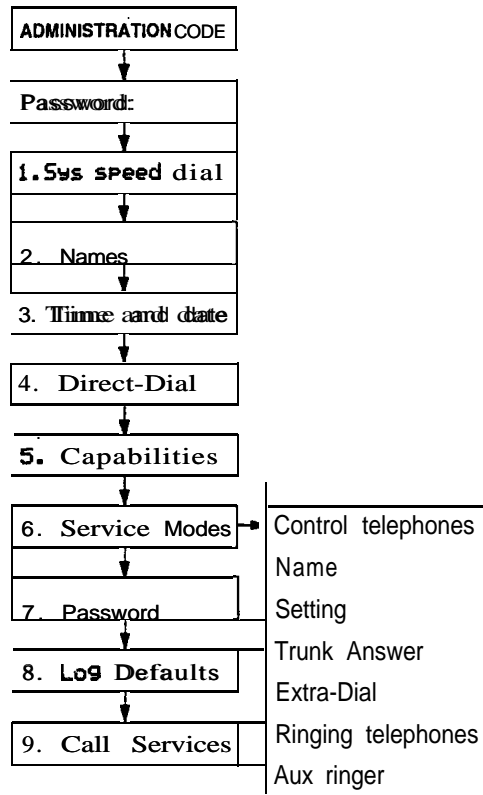

Control telephones

Control telephones are assigned to each external line and are used to control the Service Mode by allowing you to turn the Service Mode ON or OFF for that line.

Use the button, the **CHANGE**-display button, and the dial pad to program the internal number of the Control telephone for each line.

Programming hints

Only the external lines programmed with a Control telephone can be placed into a Service Mode.

You can assign a Control telephone to more than one external line, but a line cannot be assigned to more than one Control telephone.

Only one Service Mode applies at any one time to all external lines controlled by a given Control telephone.

The default Control telephone for all lines is 221.

Service Modes

The three Service Modes are programmed in the same way.

Service Mode Name

The Service Mode Name identifies the active Service Mode, and is shown on the display of the Control telephone when the Service Mode is turned ON.

Use the (Show] button, the **CHANGE** display button, and the dial pad to program the Service Mode name. For information on entering names, see the information in this chapter entitled Entering names.

Programming hints

The default names of the three possible Service Modes are only suggestions, and may be changed to any other name.

A Service Mode name can be one to seven characters.

Service Mode setting

The Service Mode setting controls how the Service Mode is turned ON and OFF. Use the **CHANGE** display button to select the setting: Manual, Automatic, or OFF.

Manual allows you to turn the Service Mode ON and OFF at any time from a Control telephone. The Service Modes feature code must be entered at the telephone to access this feature.

Automatic allows you to pre-assign a stop and start time during which the Service Mode is active. You are still able to start and stop the Service Mode by entering the Service Modes feature code at a Control telephone. If you select this setting, you will have to program start and stop times. See the section in this chapter on Time and Date for information on programming times.

OFF prevents the Service Mode from being activated.

Programming hints

Overlapping times may be assigned. For example, if Service Mode 1 is assigned from 9:00 am to 4:00 pm and Service Mode 2 is assigned from 1:00 pm to 5:00 pm, then the start time of the second Service Mode is treated as a stop time for the first Service Mode. This is also true if two Service Modes have the same start time but different stop times.

If one Service Mode starts and stops within the times of another Service Mode, the first service temporarily ends when the second service starts. The first service then resumes when the second service has ended.

Default stop and start times correspond to typical hours which may be required for a night Service Mode.

Default Service Mode times

Service Mode	Start time	Stop time
Service Mode 1: Night	23:00	07:00
Service Mode 2: Evening	17:00	23:00
Service Mode 3: Lunch	12:00	13:00

Trunk Answer

Trunk Answer allows you to answer, from any telephone, an external call which is ringing at another telephone in your office. This is useful if the other telephones have not been assigned the same lines as the telephone you are using to answer the call.

You can change the Trunk Answer setting only if the Service Mode is set to Manual or Automatic.

Use the **CHANGE** display button to select the setting: **Y** (Yes) or **N** (No).

Extra-Dial telephone

A telephone normally in service as a Direct-Dial telephone, can be programmed in Service Modes to allow internal calls to the Direct-Dial telephone to also ring at the Extra-Dial telephone.

Use the **CHANGE** display button and the dial pad to enter the internal telephone number of the Extra-Dial telephone.

Programming hints

The Extra-dial telephone provides the option of assigning one more Direct-Dial telephone in the Norstar system for each operational Service Mode.

Ringling

You can assign additional telephones to ring for incoming calls on each external line, including target lines. Use the **[Show]** button, the **ADD** display button and the dial pad to enter the internal telephone number of the Ringling telephone for each line.

You can indicate whether the Auxiliary Ringer (if installed) also rings. Use the **CHANGE** display button to select the setting: **Y** (Yes) or **N** (No).

Programming hints

The default ringling telephone is 221. This means that all lines ring at Control telephone 221, when Service Modes are activated. A Ringling telephone can be assigned to more than one Service Mode.

Password

The Administration password allows access to Administration programming. This prevents unauthorized or unintentional changes to settings. To ensure security, distribute the passwords only to selected personnel, keep a record of your password in a secure place, and change the password periodically.

The password is a one to six-digit number. The default Administration password is **A** **D** **M** **I** **N** which is the same as **2** **3** **6** **4** **6**.

Use the **S** **w** button, the **CHANGE** display button and the dial pad to enter the new Administration password. Use the **OK** display button accept the programmed password.

Programming hints

The password is easier to remember if the digits correspond to the letters in a word.

If you forget the Administration password, you are not able to access Administration programming. Call your Customer Service representative to assign a new Administration password.

Log Defaults

If you subscribe to Call Display services, external calls can be tracked in a Call Log. Log Defaults programming customizes how log space is allocated to telephones throughout the system.

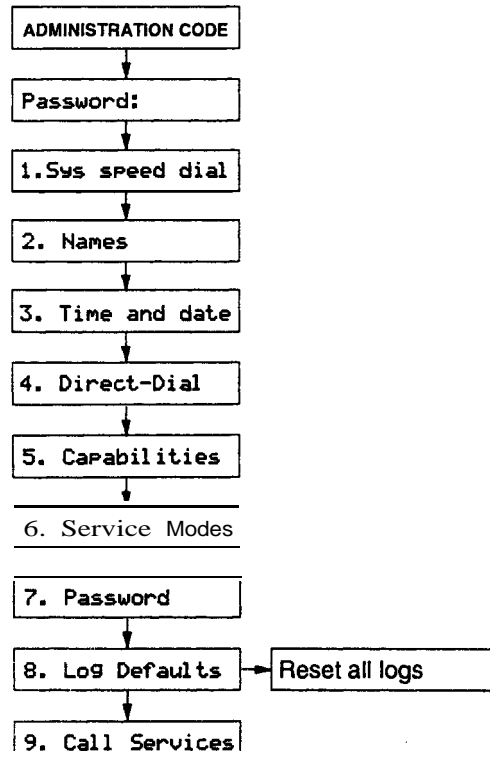

Reset All Logs

Use the **[S w]** button and the dial pad to enter the space allocation for the Call Log at each telephone. Use the **OK** display button to accept the settings and end Administration programming. The system automatically reallocates Log space.

Note: Reallocation of Call Log space may destroy Call Log data at telephones that lose space.

There are 600 Call Log spaces available in the system. There are no spaces allocated by default. Changing the space allocation using Log Defaults will define the log space available to all telephones in the system. Unassigned log space is available in a Log Pool, and can be re-allocated in Call Services programming.

Call Services

If you subscribe to Call Display services, external calls are identified on the display. Call Services programming allows you to customize how this information is used.

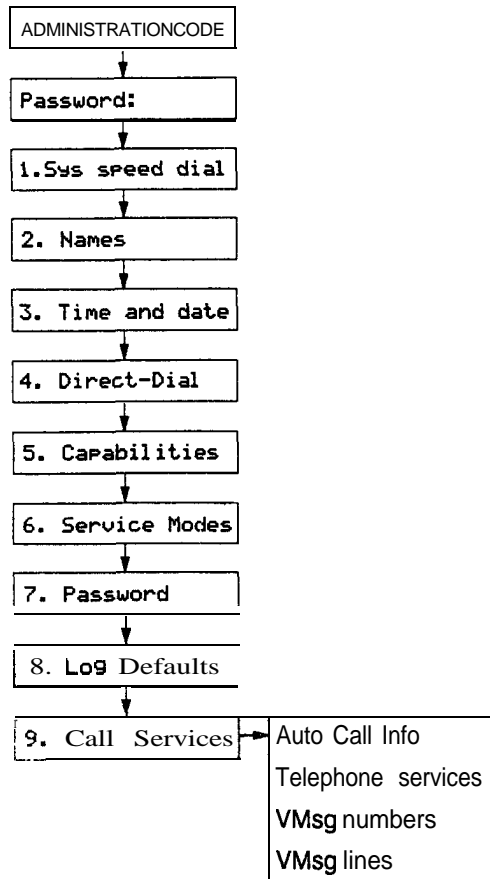

Auto Call Info

Automatic Call Information allows you to specify which telephone displays the Call Display information when a call is ringing on an external line. (After the call is answered, Call Display information is always shown at the telephone that answered the call.) Use the **SHOW** button, the **CHANGE** display button and the dial pad to enter the internal number of the telephone to display Call Display information.

Note: In order for a telephone to display the Call Display information for calls on an external line, that telephone must also be programmed to Ring for that line.

Telephone (Set) Services

Telephone Services programming allows you to customize how Call Display information is used at each telephone.

Autolog/Show Voice Message

Logging telephone (set)

Logging telephone allows you to specify the telephone that automatically logs Call Display information for calls on an external line. The line must appear on that telephone but it does not have to be a ringing line. Use the SHOW button and the CHANGE display button to select the setting: N (No) or Y (Yes).

Show External Voice Message

If you subscribe to Voice Message services, you can access that service through your Norstar system. Show External Voice Message controls the display of External Voice Message Waiting indication for each line at each telephone. Use the CHANGE display button to select the setting: N (No) or Y (Yes).

Log Space

Log Space changes the number of items that can be stored in the Call Log for each telephone. Use the button, the ADD display button and the REMOVE display button to redistribute the log space. There is no Log Space assigned by default.

Programming hints

Space must be available in the Log Pool before any space can be added to a current Call Log space.

System-wide allocation of space is performed from Log Defaults programming. If you are performing extensive changes, it may be appropriate to use the Log Defaults programming mechanism instead.

Log Password

Log Password allows you to clear any Call Log password programmed with the Call Log feature. Use the CHANGE display button to clear the programmed password.

First Display

Depending on the services you subscribe to, Call Display information may contain up to three parts; the name of the caller, the number of the caller, and the name of the line in your Norstar system that the call is on. Use the **CHANGE** display button to select the setting to be shown first for each telephone: Name, Number or Line.

Programming hints

The Call Information feature is used to display and scroll through all of the Call Display information; the caller name, number and line number. See the Telephone features chapter for more information.

You may see Unknown name or Unknown number on the display if the information is not available from your telephone company. You may see Private name or Private number on the display if the caller blocks that information.

Voice Message. Center telephone numbers

If you subscribe to Voice Message services, you can access that service through your Norstar system. This setting specifies the external telephone number that is automatically dialed by the Message feature to retrieve voice messages. Use the **CHANGE** display button and the dial pad to enter the external telephone number

Programming hints

The display does not show that external messages are waiting unless the Show External Voice Message prompt is set to Yes.

Five Voice Message Center numbers can be programmed, but most systems require only one.

Voice Message Center lines

If you subscribe to Voice Message services, you can specify which Voice Message Center is used for each external line that can receive Message Waiting indication. Use the **CHANGE** display button to select the setting: 1, 2, 3, 4, 5, or N (None).

Copying settings

Programmed settings for lines, telephones, and certain Capabilities can be copied to other lines or telephones. If many lines or telephones require the same settings, program one line or telephone, and then copy those settings.

Line programming

Line programming can be copied for Line abilities in the Capabilities section of Administration programming, and Ringing telephones in the Service Modes section of Administration programming.

Use the COPY display button and the dial pad to identify the source and destination of the copied information.

Telephone programming

Norstar telephone programming can be copied for Set Abilities in the Capabilities section of Administration programming.

Use the COPY display button and the dial pad to identify the source and destination of the copied information.

Capabilities programming

In addition to Line abilities and Set abilities, Norstar Capabilities programming can be copied for:

- Dialing filters
- Remote access packages
- COS passwords

Use the COPY display button and the dial pad to identify the source and destination of the copied information.

Set Profile and Line Profile

Use Set Profile and Line Profile to review the settings programmed in Configuration and Administration programming. Set Profile and Line Profile allow you to browse through, but not change, the programmed settings.

Set Profile allows you to verify settings for each **Norstar** telephone. Line Profile allows you to verify settings for each external line.

Using Set Profile and Line Profile

As many as four people in the **Norstar** system can use Set Profile or Line Profile at the same time. You may access Set Profile and Line Profile while on a call at your telephone.

If someone is using Configuration or Administration programming, you can still access Set Profile and Line Profile from another **Norstar** telephone. The latest programming changes can be seen as soon as they are made.

Set Profile and Line Profile can be used only from an M7310 or M7324 Telephone.

A **Norstar** Programming Overlay is not required to perform Set Profile or Line Profile.

Programming you can review

The following table shows the Configuration and Administration programming headings that can be reviewed in Set Profile and Line Profile.

Programming that can be reviewed

Set Profile	Line Profile
Set name	Line name
Line Access	Trunk data (physical lines only)
Set abilities	Received number (target lines only)
	Line data
	Line abilities
	Service Modes

The following table shows how line names and telephone names appear on the display while you are using Set Profile and Line Profile.

Telephone name	221: 221 OR 221: C WHITE	internal number:internal number or name (if programmed)
Line name	Line001:Line001 OR Line001 : WATS	external line number:external line number or name (if programmed)

To begin Set Profile

From an M7310 or M7324 Telephone:

1. Press * * 7 3 8 , which is the same as * * S E T .

The display shows Show set: **---**

2. Enter the internal number of the telephone to be reviewed.
OR
Press FIRST to review programming for the telephone with the first internal number.

The display shows, for example, **221: 221** or **221: C WHITE**, if that name was programmed for the telephone.

To begin Line Profile

From an M7310 or M7324 Telephone:

1. Press * * 5 4 6 3 , which is the same as * * L I N E

The display shows Show 1 **line:---**

2. Enter the number of the line to be reviewed.
OR
Press FIRST to review programming for the first line number.

The display shows, for example, **Line001: Line881** or **Line001: WATS**, if that name was programmed for the line.

To exit Set Profile or Line Profile

1. Press .

Using Set Profile

Begin with 221: 221 or 221: **C** WHITE.

1. To see the name for the next telephone, (or to return to Show set: **—**, if this telephone is the telephone with the last internal number), press **NEXT**.

OR

To see the name for the previous telephone (or to return to Show set: **—**, if this telephone is the telephone with the first internal number), press **BACK**.

O R

To review settings for this telephone, press **SHOW**.

The display shows **Line Access**.

2. To see programming for Line Access. press **SHOW**.

OR

To display the name of the telephone, as in step 1, press **BACK**.

OR

To review the next setting, press **NEXT**.

The display shows **Set Abilities**.

3. To see programming for Set Abilities, press **SHOW**.

OR

To display Line Access, as in step 2, press **BACK**.

OR

To return to the name of the telephone. press **NEXT**.

Using Line Profile

Begin with **Line009:Line009** or **Line009:WATS**.

1. To see the name for the next line, (or to return to Show 1 **ine: -**, if this is the last line number), press **NEXT**.
OR
To see the name for the previous line, (or to return to Show 1 **ine: -**, if this is the first line number), press **BACK**.
OR
To review other settings, press **SHOW**.

The display shows Trunk data.
2. To see programming for Trunk data, press **SHOW**.
OR
To display the name of the line, as in step 1, press **BACK**.
OR
To review the next setting, press **NEXT**.

The display shows Line data.
3. To see programming for line data, press **SHOW**.
OR
To display Trunk data, as in step 2, press **BACK**.
OR
To review the next setting, press **NEXT**.

The display shows Line abil **ities**.
4. To see the programming for Line Abilities, press **SHOW**.
OR
To display Line data, as in step 3, press **BACK**.
OR
To review the next setting, press **NEXT**.

The display shows **Service** Modes.
5. To see the programming for Service Modes, press **SHOW**.
OR
To display Line abil **ities**, as in step 4, press **BACK**.
4.
OR
To return to the name of the line, press **NEXT**.

Programming reminders

The Programming reminders are a record of programmable settings which Norstar users may need to know on a day-to-day basis.

Fill out whatever sections are programmed and must be known. If more space is required to record the information, first photocopy the page before you begin. Not all of the programmable features may be required information.

Programmable settings can be determined from a review of the *Norstar Modular DR5 Programming Record* and use of the Set and Line Profile feature.

Distribute the Programming reminders to each desk that has a Norstar telephone, or post them on the wall next to the telephone.

Prime telephones

Prime Telephone operator
internal number
Lines answered at the Prime telephone

Prime Telephone operator
Internal number
Lines answered at the Prime telephone

Prime Telephone operator
Internal number
Lines answered at the Prime telephone

Prime Telephone operator
internal number
Lines answered at the Prime telephone

Central Answering Position

CAP operator	Internal number
	- - - - -
	- - - - -
	- - - - -
	- - - - -
	- - - - -

Page zones

Page zone	Location
1	
2	
3	
4	
5	
6	

Line Pools

Pool	Access code	Use
A	- - - -	
B	- - - -	
C	- - - -	
D	- - - -	
E	— — — —	
F	— — — —	
G	- - - -	
H	- - - -	
I	- - - -	
J	- - - -	
K	- - - -	
L	- - - -	
M	— — — —	
N	- - - -	
O	- - - -	

Miscellaneous programming

Direct-dial telephone	— — — — — — — —
DISA DN (used to change COS)	- - - - - - - -
Direct-dial digit	—
Call Park Prefix digit	—
Dial first to make external calls	—

Call Pickup Groups

Pickup Group	Names of members of the group
—	<hr/> <hr/> <hr/> <hr/> <hr/> <hr/> <hr/>
—	<hr/> <hr/> <hr/> <hr/> <hr/> <hr/> <hr/>
	<hr/> <hr/> <hr/> <hr/> <hr/> <hr/> <hr/>

Telephone features

Answer a call

Answering the telephone 77

Call Information 91

Call Pickup 78, 104

Bring another person into
a telephone conversation

Conference 110

Group Listen 132

Handsfree/Mute 78, 133

Privacy 110

Change your telephone defaults

Button Inquiry 129

Contrast Adjustment 116

Class of Service 115, 173, 185

Customizing your telephone 116

Dialing Modes 117, 124

Do Not Disturb 78, 88, 128

Feature programming 122

Language Choice 118

Line appearance 174

Line buttons 119, 155

Lines 173

Norstar Telephones 154

Prime line 175

Private lines 175

Ring Type 120

Ring Volume 121

Telephone Admin. Lock 121

Check the length of a call

Call Duration Timer 177

Show Time 177

Communicate within your office

Dialing 123

Direct-dial 123, 165

Page 158

Priority Call 160

Ring Again 123

Voice Call 187

Handle many calls at once

Answer buttons 154

Central Answering Position 164

Call Queuing 78

Hold 135, 154

Prime telephone 78 167

Have your calls answered at
another telephone

Call Forward 88

Line Redirection 142

Service Modes 162

Log your incoming calls

Autobumping 95

Call Log 92, 93

Logit 94

Make calls quickly without
having to dial the whole number

Autodial 85

Hotline telephone 166

Last Number Redial 123

Messages 148

Speed Dial 168

Saved Number Redial 124

Make calls to numbers outside
your **Norstar** system

Dialing 123

External line access code 123

Host System Signaling 137

Line Pools 124, 140, 175

Transfer a call to another person

Call Park 102

Camp 108

Transfer 108, 112, 178

External Transfer 178

Network Transfer 178

Using Norstar features

To use a Norstar feature, enter the feature code and watch your telephone display for instructions. Different displays come up at different times, depending on how you invoke the feature and the choices you make while using the feature. If you want more information about a display, look it up in the Displays section of each feature listing.

Note that some features work only in certain circumstances. For example, to use Conference you must have two calls at your telephone, one active and one on hold.

The displays shown in this book use a two-digit internal number, which is the default for a non-expanded system. (An expanded system has a 3-digit internal number default.)

One-line and two-line displays

All Norstar telephones have LCD displays that give you information about your calls and guide you through Norstar features. The M7100 and M7208 Telephones have a one-line display. The M7310 and M7324 Telephones have a two-line display. The second line of a two-line display shows the functions of the three buttons directly below it. If you have a telephone with a two-line display, you can use these display buttons. Some display buttons, such as TRNSFER and ALL, are simply shortcuts. If you have a telephone with a one-line display, these shortcuts are not available. Other display buttons, such as OK and SHOW, perform essential functions. If your telephone has a one-line display, you can use the following buttons in place of these display buttons:

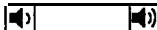
<u>OK</u>	[Hold]	<u>CANCEL</u>	#
<u>QUIT</u>	[Ris]	<u>UIEW</u>	#
<u>ADD</u>	*	<u>OUERRIDE</u>	#
<u>SHOW</u>	#	<u>BKSP</u>	

All displays listed in this book are shown as they appear on the two-line display, except those that appear only on telephones with a one-line display. If you are using a telephone with a one-line display, ignore both the second line of the display shown in this book, and the instructions for using display buttons.

Common feature displays

You may see the following displays when you use a feature.

Access denied

Someone is using Configuration or Administration programming. You cannot use programming features. Try again later.

Feature timeout

You have taken more than 15 seconds to press a button in response to a display.

Invalid code

You have entered an invalid feature code.

Not available

You have tried to use a feature that is not available in the present set-up of your **Norstar** system.

Set, locked

You cannot use the feature you have chosen because your telephone is locked. See Telephone Administration Lock in Customizing your telephone.

Dialing and Answering the telephone

Many **Norstar** features require you to dial telephone numbers. The displays associated with dialing are listed in the Dialing section. If you see a display that is not listed with the feature you are using, look for it in the Dialing section. All the displays that appear when you are receiving a call are listed in the Answering the telephone section.

76 / Using Norstar features

One button access

You can program most **Norstar** feature codes onto telephone memory buttons so that you can use the feature by pressing a single button. See the procedures in the Feature programming section.

Whenever the instructions tell you to enter a feature code, you can do so either by pressing the buttons shown in the feature description or by pressing a memory button on which the feature code has been programmed. You can also enter a telephone number by pressing an **Autodial** button, rather than entering it manually.

Canceling a feature

Some features change the way your telephone works. To make your telephone work normally again you must cancel the feature. To cancel a feature, press **[Feature]**, then **Q** and the feature code. For example, to cancel Call Forward, which you activate by pressing **[Feature] 4**, press **[Feature] # 4**.

If a feature code is programmed onto a memory button, you may be able to cancel the feature by pressing the memory button while the feature is active.

If you change your mind in the middle of using a feature, you can back out by pressing **[Feature]** or **[Ris]**. Be aware that pressing **[Ris]** disconnects any active or held call.

M7100 Telephone

Because the M7100 Telephone does not have any line buttons it sometimes works slightly differently from other **Norstar** telephones. Where other telephones may require you to select a line button to answer a call, on the M7100 Telephone you simply pick up the receiver. Where other telephones require you to select a line button to take a call off hold, you press **[Hold]** on the M7100 Telephone. The M7100 Telephone cannot have a **[Handsfree]** button. You will find special instructions for the M7100 Telephone in some feature descriptions.

Answering the telephone

A n s w e r i n g

Your Norstar telephone can receive many different types of calls. Your telephone's display tells you what type of **call** you are receiving. The usual way to answer a call is to pick up the receiver, but there are several other possible methods, depending on how your system is set up and the type of call that is ringing.

Callback

When you direct a call you have answered to another telephone, the system monitors the call to make sure someone answers it. If no one answers a call within a programmable length of time, the system directs it back to you. Callback generates a variety of displays. Most occur after a programmable delay and are listed in this section. Some occur immediately, if the telephone to which you are directing a call is out of service or otherwise unavailable. These are listed with the descriptions of the features in which they occur.

Delayed Ring Transfer (DRT)

If no one answers a call within a programmable length of time, the system transfers the call to the Prime telephone.

Call Display information

If you have subscribed to Call Display services from your local telephone company, one line of information about an external caller is displayed after you answer. If your telephone has been programmed to receive Call Display information automatically, that information is shown before you answer. Depending on the setting in Administration Programming and the external information available, either the caller's name or telephone number is displayed.

When you transfer an external call to another **Norstar** user, this information is displayed on the recipient's telephone.

There will be a delay between the time your telephone rings and when Call Display information is available. If you answer a call before the Call Display information arrives, that information is not available for the call.

Related features

Call Pickup

Call Pickup lets you use your telephone to answer a call that is ringing at someone else's telephone.

Call Queuing

Call Queuing allows you to choose the call with the highest priority when you have more than one call ringing at your telephone.

Do Not Disturb

Feature 8 5

If you do not wish to receive calls, turn on Do Not Disturb.

Handsfree/Mute

Handsfree

You can answer calls without picking up the receiver using Handsfree/Mute.

Prime telephone

A Prime telephone receives calls that go unanswered at other telephones. For more information, see Special telephones.

Retrieving a Parked Call

You can retrieve a parked call at any telephone in the system.

Voice Call Deny

Feature 8 8

If you do not wish to receive voice calls, turn on Voice Call Deny.

What line indicators mean

▶Flashing on and off for equal lengths of time	There is an incoming call on the line.
▶Flashing on and off more quickly	You have placed a call on hold.
▶Flashing on for longer than off	Someone else has put a call on hold on that line.
▶On, not flashing	You are connected to the call on that line or the line is in use elsewhere.
Off	The line is free.

Rings you may hear

A double beep every ten seconds	A call has been camped to your telephone.
A long single ring	There is an external call on the line for you.
A shorter double ring	There is an internal call on the line for you or a call is being transferred to you.
A brief single ring	A call is being redirected on one of your redirected lines. You cannot answer this call. See Line Redirection.
Three beeps ^p descending in tone	You are receiving a priority call.

Displays

You will see one or more of the following displays when you receive a call on your telephone and while you are answering that call. See Messages for a full explanation of the Messages feature. See Dialing for a full explanation of Ring Again.

S

This indicates a long distance call. (May be available with Call Display Services.)

221
TRANSFER

You are connected to an internal call. You can press **TRANSFER** to transfer the call.

02>221

Either you are receiving an internal call from telephone 02 forwarded by telephone 221 or you have an Answer button for telephone 221 and an internal call from 02 is ringing on 221.

221 call in9

You are receiving a call from telephone 221.

Call 221?
YES NO

You have received a Ring Again offer for a call to an internal telephone. To call the number again, press **YES** or the flashing internal line button. On the M7100 Telephone, just lift the receiver. Otherwise, press **NO** or wait 30 seconds for the Ring Again offer to expire. For an explanation of Ring Again, see Dialing.

Camped: 221
CALLBACK

The person to whom you camped the call did not answer it. The call has come back to you. Press the **CALLBACK** button or the line button to reconnect to the call.

Line001
TRANSFER

You are connected to an external call. You can press **TRANSFER** to transfer the call.

Line001 transfer

The call on line 001 is being transferred to you by someone else in your **Norstar** system.

Line001 waiting

A camped call is waiting. Press the line button or use Call Queuing to answer the call. If you have an M7100 Telephone, press **Hold**.

Line001>221

Either you are receiving an external call forwarded from telephone 221 or you have an Answer button for telephone 221 and an external call is ringing on that telephone.

No calls waiting

You tried to use Call Queuing but no call was ringing at your telephone.

No line selected

There is no call ringing at your telephone. If you have a flashing line button but your telephone is not ringing, you must press the line button to answer the call on that line.

Hot in service

The telephone to which you have directed a call is not in service or is otherwise unavailable. The call is returned to your telephone.

**call
CALLBACK**

Nobody answered the call you parked. The call has come back to you.

Pick UP receiver

You have used the Call Queuing feature without picking up the receiver. Auto Handsfree has not been assigned to your telephone. You must use the receiver or **Handsfree** to answer a ringing or camped call.

Priority>221
BLOCK

You are receiving a Priority Call. If you are on another call, inform the person you are speaking to that the call is about to be put on hold. Press the flashing line indicator of the Priority Call or wait till the call connects automatically (in eight seconds). The Priority Call goes through when you hear the next beep.

Your active call is placed on Exclusive Hold. It will be reconnected automatically when the priority call ends (unless you transfer the Priority Call, in which case you must press the line button of your original call to reconnect).

To reject a Priority Call, use DND (Feature L 8 9) or press K_____.

/Release a call

You have no free line buttons on which to receive a call. Release one of your current calls and try again to answer the incoming call.

Use 1 line pool?
YES NO

You have received a Ring Again offer for a line pool. To use the line pool, press **YES** or the flashing internal line button. On the M7100 Telephone, just lift the receiver. Otherwise, press **NO** or wait 30 seconds for the Ring Again offer to expire. For an explanation of Ring Again, see Dialing.

Prime telephone displays

If yours is a Prime telephone, you may see the following displays:

DND from 221

The person at telephone 221 has forwarded a call to you using Do Not Disturb.

DND transfer	The system has transferred a call to you from a telephone in Do Not Disturb mode.
DRT Line001	Nobody answered this call so the system transferred it to you.
Line001 call back CALLBACK	Someone has camped, parked or transferred a call on line 001, but no one has answered it. Press the CALLBACK button or the line button to connect to the call.
Line001 to prime	There is no telephone that can receive a call on line 001 so the System has transferred it to you.
Line015>Line087	The call coming in on line 015 was intended for target line 087. Line 087 is busy so the call has come to you.

Notes

There are three indications of an incoming call: ringing, a line button flashing, and a message on the display. You will not necessarily receive all three indications for any particular call. You may have a line that has been set up not to ring at your telephone. If so, you will see only a flashing line button. If there is no button free for a camped call to appear, you will get a special ring and a message on your display, but no line button will flash. If someone makes a voice call to you, you will hear a beep followed by their voice. There are many possible combinations, depending on how your system is set up. See Lines in the System features section for more information on the use of lines.

There are many ways to answer a call. Many of them depend on settings in Administration programming. Depending on various settings and the type of call you are receiving, you may be able to answer a call by: picking up the receiver, picking up the receiver and pressing a line button, pressing **Handsfree**, pressing **Handsfree** and pressing a line button, pressing a line button, or simply speaking.

If you receive a Priority Call and your telephone has no free internal line buttons, you cannot transfer the call or do anything else with it, except release it.

On M7100 Telephones, you may answer a second call by pressing . Your active call is put on hold and you are connected to the waiting call. You can have no more than two calls at a time.

Autodial

You can program memory buttons for one-touch dialing of internal or external telephone numbers.

External Autodial

Feature * 1

1. Press **Feature** * **1**.
2. Select the button you want to program. This is not necessary for the M7100 Telephone.
3. If you want this autodialer to use a particular line or line pool, select that line or line pool button. You can only select a line pool button on the M7100 Telephone.
4. Enter the number.
5. Press **OK** or **[Hold]**.

Internal Autodial

1. Press **Feature** * **2**.
2. Select the button you want to program. This is not necessary for the M7100 Telephone.
3. Enter the number.

Displays

You will see some of the following displays while programming an Autodial button. See Dialing for displays that may occur while using an Autodial button.

987_
QUIT BKSP OK

Continue to enter digits until the number is complete. Press **BKSP** or ⇒ **[Left Arrow]** **[Right Arrow]** to erase an incorrect digit. Press **OK** or **[Hold]** when you are finished.

Autodial full

The memory allotted to Autodial numbers in your Norstar system is full.

Button erased

While programming External Autodial, you pressed **OK** or **Hold** before entering any digits. This erases the button.

Enter digits
QUIT OK

Enter the number you wish to program exactly as you would if you were dialing it yourself.

Hold or release

You cannot program an **Autodial** button while you are on a call. Finish your call or place it on hold before programming an **Autodial** button.

Intercom #: _
QUIT

Enter the internal telephone number you wish to program.

Press a button
WIT

Press the memory button you want to program.

Program and HOLD

This display pertains only to the M7208 Telephone. Enter the number you want to program onto the button, then press **[Hold]**. You may include a line or line pool selection in an **autodial** sequence by selecting the line before entering any digits.

Program and OK
QUIT OK

Enter the number you want to program onto the button, then press **Hold** or **OK**. You may include a line or line pool selection in an **autodial** sequence by selecting the line before entering any digits.

Programmed

The number is stored on the button.

Notes

If the power to your Norstar system is off for more than three days, Autodial numbers may be lost from the memory.

Autodial numbers must be programmed onto memory buttons. They can not be programmed onto line buttons, the Handsfree/Mute button, or Answer buttons.

You can program Host System Signaling codes as part of a number on an External Autodial button. See Host System Signaling.

If you do not include a line selection in an autodialer, the call will use your Prime line, if you have one. If you select a line before pressing the Autodial button, any line selection programmed onto the button will be ignored.

You can copy the telephone number from a Last Number Redial button or Saved Number Redial button onto an Autodial button. Simply enter the Last Number Redial feature code or Saved Number Redial feature code when the Autodial feature asks you to enter a number.

Call Forward

(Feature)

Forward your calls

You can have all your calls forwarded to another telephone in the Norstar system.

1. Press .
2. Enter the number of the internal telephone to which you want your calls forwarded.

Forwarding remains in effect until you enter the Cancel Call Forward feature code.

Cancel Call Forward

#

You can start to receive calls again.

1. Press # .

Call Forward on Busy

Call Forward on Busy redirects calls to another telephone when you are busy with a call. The System Coordinator sets up Call Forward on Busy in Administration programming.

Call Forward (No Answer)

Call Forward (No Answer) forwards unanswered calls to another telephone. The System Coordinator sets up Call Forward (No Answer) in Administration programming.

Call Forward Override

You can call someone and ask them to stop forwarding their calls to you.

1. Dial that person's number and ask them to cancel call forwarding. Your call will ring at that person's telephone even though they are forwarding their calls.

Related features

Do Not Disturb

You can use the Do Not Disturb feature to forward your calls to the Prime telephone.

Line Redirection

Feature 8 4

Note the differences between Line Redirection and Call Forward. Call Forward forwards all calls that arrive at a particular telephone to another telephone within the Norstar system. Line redirection redirects only the lines you specify, no matter which telephones they appear on, to a telephone outside the Norstar system.

Displays

You will see some of the following displays while forwarding your calls. See Do Not Disturb for a full explanation of that feature. See Answering the telephone for displays that occur when a telephone receives a call forwarded by another telephone.

Forward denied

You cannot forward calls to the number you have chosen. There are several reasons why this can happen. For instance, you cannot forward your calls to a telephone that has been forwarded to your telephone.

Forward to:

Dial the internal number or press the Internal **Autodial** button of the telephone to which you want your calls to be forwarded.

Forward>221
CANCEL

Your calls are being forwarded to telephone 221. Press the **CANCEL** button or **Feature # 14** if you want to stop forwarding your calls.

Not. in service

Two or more telephones are linked in a forwarding chain, and one of them is out of service or is being used to program the system.

Notes

When a call is forwarded, it does not ring but its line indicator still flashes on your telephone. You can answer the call by pressing the button next to the flashing indicator.

If the telephone to which you forwarded your calls does not have the same external lines as your telephone, the forwarded calls appear on internal line buttons.

Telephones that have Call Forward on Busy active can still receive Priority calls. Call Forward on Busy does not forward camped calls.

When Call Forward is active, all calls go to the call forward destination, regardless of the Call Forward on Busy and Call Forward no Answer settings.

If you are one of a group of people who regularly forward their calls to one another, be aware that it is possible to set up forward loops in which a call is forwarded from one telephone to another in a circle, and is never answered anywhere.

Calls that are redirected by Line Redirection are not affected by any of the Call Forward features.

Call Information

Feature 8 1 1

Call Information allows you to display information about incoming calls. This information is more detailed than the Call Display information you automatically receive. See the Answering the telephone section in this chapter for details. For external calls, you can display the caller's name, telephone number, and the line name. For an internal call, you can display the name of the caller and their internal number. You can obtain information from ringing, answered, or held calls.

Names and numbers for external callers are displayed only if you have subscribed to Call Display services from your local telephone company.

Display Call Information before or after answering

1. To find out who is calling or to obtain information about your current call, press **Feature 8 1 1**.
2. If the call is an internal call, the caller's name and the internal number are displayed.
OR
If the call is an external call, Call Display information is displayed according to how this feature was programmed in Administration programming.

To **obtain** more information about an external call:

For a one-line display, press **Q** repeatedly to display more information about the call.

OR

For a two-line display, continue to press **VIEW** to display more information about the call.

Display Call Information for a call on hold

1. To obtain information about your held call, press **Feature 8 1 1**.
2. The display shows **► Select** a call.
3. Select the line on hold.

4. If the call is an internal call, the caller's name and internal number are displayed.

OR

If the call is an external call, the caller's information is displayed.

To obtain more information about an external call:

For a one-line display, press **I#** repeatedly to display more information about the call.

OR

For a two-line display, continue to press **VIEW** to display more information about the call.

Related features

Call Log

Call Log displays the same information as Call Information, along with the date and time of the call, and the number of times the caller called.

Displays

```
▶5551234
EXIT VIEW
555
```

You would see this display if you were on an **active** call with a caller at -1234

```
▶55551234
(EXIT VIEW
```

You would see this display if you were on an active long distance call with a caller at 555-1 234.

'Notes

Call Display information becomes available between the first and second ring of an alerting call. If you answer before the Call Display information is available on your display, and you press **[Feature] 8 1 1**, you will only see the line number or line name.

Call Log

Call Log creates a list of records of incoming external calls. The log could contain the following information for each call:

- | sequence number in the Call Log,
- name and number of caller,
- indication if call was long distance,
- indication if call was answered (and identification of who answered it),
- time and date of the call,
- | number of repeated calls from the same source, and
- name of the line that the call came in on.

Call Log has many benefits. For example, you may find it helpful to :

- keep track of abandoned or unanswered calls,
- call back a customer who was unable to reach anyone,
- track patterns for your callers (for example volume of calls and geographical location of calls),
- record caller information quickly and accurately, and
- | build a personal telephone directory from log items.

Log space is assigned to each telephone. Since a log can become full, Call Log has Autobump, which when set to ON, allows new calls to be logged, while at the same time deleting old entries.

Names and numbers for external callers are displayed only if you have subscribed to Call Display services from your local telephone company.

To manually log an external call:

1. Press [Feature] [8] [1] (3).
OR
Program this feature on a memory key (See the Norstar Telephones section in this chapter.)

Use Autobumping

[Feature] [8] [1] [5]

'Since your log has a set number of entries that it can hold, Autobumping is a feature that lets you tell Norstar what to do when your log becomes full. When Autobumping is ON, a new log entry causes the first entry to be deleted. If Autobumping is OFF, your Norstar system will not log new calls when your log is full.

1. To turn Autobumping ON, press [Feature] [8] [1] [5].
OR
To turn Autobumping OFF, press [Feature] [#] [8] [1] (5).

Enter Call Log



[Feature] [8] [1] [2]

You can enter your Call Log to view stored information. The Log may display special characters. These are described in detail in the description of Displays, later in this section. To view your log:

1. Press [Feature] [8] [1] [2].
2. The display shows the number of previously read items (Old) and the number of new, unread items (New) in the log.
3. To view old items, press OLD or [*].
OR
To view new items, press, NEW or Q .
OR
To return to an item viewed when you last exited the log, press RESUME or [0].

Navigate within Call Log

You can navigate within your Call Log to view a particular log entry. You can also scroll within an entry itself.

1. To scroll through an entry, press MORE or    ←
OR
To view the next entry, press NEXT or Q .
OR
To go back to the previous entry, press * .
2. To exit, press Rls .

Erase Log Items

It is necessary to routinely erase read log items to make space for new items in your log.

1. Navigate to the item you want to erase.
2. Press ERASE or  .
3. To exit, press Rls .

If you accidentally erase an item, you can undo the erasure.

1. Immediately after accidentally erasing an item, press UNDO
Or  .
2. To exit, press Rls .

Call from Call Log

You may find it helpful to place calls from within your Call Log. Each stored caller number may vary according to the information associated with that particular call. If the caller number involves a Centrex or PBX system, the first few digits may need to be “trimmed” to make the caller number dialable. If the number that you want to call is long distance or uses line pool access, digits may need to be added to the beginning of the number.

Place a call

1. Navigate to the log item for the number that you want to dial.
2. Display the number and edit it if necessary to make it dialable (the instructions for adding or trimming digits follow).
3. Press an external line or line pool button.

4. Lift the receiver. This is not necessary if Handsfree is programmed at your telephone.
5. The displayed number is dialed.

Trim a number involving **Centrex** or PBX

To trim the caller number:

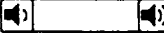
1. Press **TRIM** or ⇒ , once for every digit that you want to remove.



‘Add digits for long distance or line pool access

1. Add digits to the number by pressing the appropriate dial pad digits, just as you would do to dial.
2. To remove digits you have added, press **BKSP** or ⇒ , once for every digit that you want to remove.



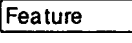

Optional Password

You have the option of accessing your Call Log through a password. If you forget your password, there is a facility in Administration programming to clear it (and then you could enter a new password from your telephone).



Assign a password to your Call Log

1. Press  *  . The display shows **New Password: ...**
2. Enter your four-digit password. The display shows **Repeat New: ...**
3. Re-enter your four-digit password. The display shows **Password changed**, which confirms that your password has been assigned.

Using your Password to enter Call Log

1. Press     to enter Call Log.
2. If you have programmed a password, **Password: ...** appears.
3. Enter your four-digit password.

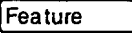
Change your password

1. Press  *  . The display shows **Old Password: ...**

2. Enter your old password. The display shows
New **Passwrd:** ...
3. Enter your new four-digit password. The displays shows
Repeat New: ...
4. Re-enter your password. The display shows
Password changed, which confirms that your password has
been changed.

Delete an assigned password

After assigning a password to your Call Log, you may later decide that you do not want to use a password at all.

1. Press **Feature** ***** **8** **5**. The display shows
Old Passwrd: ...
2. Enter your old password. The display shows
New **Passwrd:** ...
3. Press **OK** or **[Hold]**. The display shows
No **pswd** assigned, which confirms that your password has
been deleted.

Related features

Call Information

The same Call Display information as in Call Log is displayed, but it is not recorded in a log.

Displays

You will see some of the following displays as you use Call Log.

**12:KATE SMITH
NEXT ERASE MORE**

This is a Call Log item with its sequence number. When the first digit is underlined, it is a new item.

**12)KATE SMITH
NEXT ERASE MORE**

This indicates that the call was answered.

**12\$KATE SMITH
NEXT ERASE MORE**

This indicates a long distance call.

49/1234567890123
NEXT ERASE MORE

The "slash" symbol (/) indicates that the displayed information for a call has been truncated.

Jan 4 9:00a 3X
NEXT ERASE MORE

This is the repeat call counter, shown along with time and date display. It indicates the number of calls you have received from the same caller.

Autobumping O N

The Autobumping feature is active.

Autobumping OFF

The Autobumping feature is deactivated.

Call(s) bumped

One or more calls have been autobumped.

Call for you

There is one new item in the Call Log.

Calls for you 1

There are two or more new items in the Call Log.

Call logged

The call was successfully logged with Logit.

Hold or release

Your active call must be held or released before entering Call Log.

In use: SETNAME

The external line is in use.

Item erased

The item was erased from the Call Log.

Line001 227
NEXT ERASE MORE

This display shows that this call was answered at telephone 227.

Line001 Logit
NEXT ERASE MORE

This display shows that this call was manually logged.

Line001
NEXT ERASE MORE

This display shows that this call was not answered.

Log is empty

Your Call Log is empty.

Log is full

No additional calls can be logged until you either turn Autobumping ON, or you delete some items in your log.

Messages & Calls
MSG CALLS

This indicates that there are one or more items in your Message Waiting List, and there are one or more new entries in your Call Log.

New calls begin

This appears before the first "New" item when navigating from the "Old" items to the "New".

(No free lines

All lines in the pool are in use.

No info to log

No information is available on the call.

No log assigned

No log space has been assigned to the telephone.

No new items

There are no new calls in the Call Log.

No old items

There are no old or "viewed" items in the Call Log.

No resume item

The resume item is no longer in the Call Log due to Autobumping, repeat call update, or log reallocation.

Private name

The caller's name is private.

Private number

The caller's number is private.

Release calls

On an M7100 Telephone, the active call must be released before entering Call Log.

1: Unknown call

The caller's name and number are unknown.

1: Unknown name

The caller's name is unavailable.

1: Unknown number

The caller's number is unavailable.

Notes

You may want to use the punch-out overlay, which is provided in the Call Log Feature Card. This card is available in a separately orderable Call Display Button Cap Kit. Please contact your Customer Service representative.

The long distance indicator, as well as the caller's name and number, may not be shown in the log, depending on the Call Display services provided by your local telephone company.

For tips on programming Call Logs, see the Call Display services section.

Call Park

Feature

Park a call

You can suspend a call so that it can be retrieved from any telephone in your system.

1. Press .
2. Use the Page feature to announce the retrieval code displayed by your telephone.

Retrieving a parked call

1. Select an internal line.
OR
If you have an M7100 Telephone, pick up the receiver.
2. Dial the call park retrieval code.

Displays

You will see some of these displays while parking a call. You may see some of these displays while retrieving a parked call.

Al ready parked

The person you were talking to has already parked your call. You cannot park the same call.

Get call first

You have attempted to park a call with no active call on your telephone. If the call you wish to park is on hold, you must reconnect to it before you can park it.

Inval id number

You have entered an invalid retrieval code.

No call on: 101

There was no call on the retrieval code you entered.

No call to park

You have attempted to park a call, but there are no calls at your telephone.

Park denied

You have tried to park a conference call. Split the conference and park the calls separately. The person who retrieves the calls can reconnect the conference.

Parked on: 402
PAGE EXIT

Record the code shown. Use Page (**Feature**) or press **PAGE** o announce the call and its retrieval code.

Parking full

All available retrieval codes are in use. Transfer the call or take a message instead.

Notes

When you park a call, the system assigns one of nine codes for the retrieval of the call. These codes consist of the Call Park prefix, which may be any digit from 0 to 9, and a two digit call number between 01 and 09. For example, if the Call Park prefix is 4, the first parked call is assigned Retrieve Park code 401.

Your Installer sets the Call Park prefix in Configuration programming. If the Call Park Prefix is set to None, parking is disabled.

Your installer also sets the Call Park Callback delay in Configuration programming. External calls parked for longer than the program delay are returned to your telephone.

Call Pickup

You can pick up a call that is ringing at another telephone.

Directed Pickup

[Feature] 7 6

You can answer any telephone that is ringing in your Norstar system

1. Press [Feature] 7 6 .
2. Enter the internal number of the ringing telephone.

Group Pickup

[Feature] 7 5

Your Norstar system can be divided into as many as nine Pickup groups. If you are a member of a pickup group, you can pick up a call that is ringing at any telephone in your pickup group:

1. Press [Feature] 7 5 .

Trunk Answer

[Feature] 8 0 0

The Trunk Answer feature allows you to answer an external call that is ringing at any other telephone in your office.

Trunk Answer works only with calls that are ringing on lines for which a Service Mode is active and if Trunk Answer is ON in Administration programming.

1. Press [Feature] 8 0 0 .

Displays

You may see some of these displays while using a Call Pickup feature.

Already joined

You are already connected to the telephone that made the call you are trying to pick up. This can happen if you are on a call to a co-worker, your co-worker dials the number of a telephone in your Pickup group, and you attempt to pick up that call.

Denied in admin

Your telephone is not a member of a Pickup group.

No button free

You have tried to pick up a call when you have no line button available.

Pickup denied

(Pickup) There is no call that you can pick up or the call that was ringing has already been answered.

(Trunk Answer) The call that is ringing is on a line that is not in a Service Mode.

You have attempted to pick up a call on someone else's private line.

Pickup:

Enter the internal number of the telephone that is ringing. (You may use an Internal **Autodial** button to do this.)

If you decide not to answer a ringing call once you have activated Directed Pickup, press . The call will continue to ring.

Notes

Call Pickup cannot be used on private lines. Group Pickup can not be used to retrieve a camped call.

To use Directed Pickup, the telephone must be ringing. If, for example, the auxiliary ringer is ringing, but the call is not ringing at a telephone, the call cannot be answered using Directed Pickup. It must be answered normally at a telephone that has a flashing indicator for the call, or by using Trunk Answer.

If a call is ringing on an Answer button, you can use Directed Pickup to answer the call by entering the internal number of any member of the Answer group.

If there is more than one incoming call at a telephone in a pickup group, a call ringing on the Prime line is answered first followed by calls on external lines and, finally, calls on internal lines.

If there is more than one incoming call on lines in a Service Mode, the Trunk Answer feature picks up the external call that has been ringing the longest.

The System Coordinator can assign telephones to one of nine Pickup groups in Administration programming.

Call Queuing

Feature 8 0 1

When you have more than one call ringing at your telephone, you can choose the call that has the highest priority.

1. Press Feature 8 0 1 .
2. The system connects you to the call that has the highest priority.

Notes

Call Queuing answers incoming calls before callback and camped calls.

Call Queuing can be programmed onto a memory button.

Camp On

 Feature 8 2

Camp a call

You can send an external call to another telephone, even if all its lines are busy.

1. Press Feature 8 2 .
- 2 . Dial the number of the telephone you want to camp the call to.

Related features

Transfer

 Feature 7 0

Camp On is a variation of the Transfer feature.

Displays

You will see some of the following prompts while Camping a call.

221 CAMP max
CALLBACK

You tried to camp a call to a telephone that already has a camped call. The call has come back to you. Press the **CALLBACK** button or the line button to reconnect to the call. On the M7100 Telephone, just pick up the receiver.

221 DND
CALLBACK

The person to whom you redirected a call has Do Not Disturb active on the telephone. The call has come back to you. Press the **CALLBACK** button or the line button to reconnect to the call. On the M7100 Telephone, just pick up the receiver.

CAMP denied

You have tried to camp an internal call. You can only camp external calls.

'Camp to:
CANCEL

Dial the number of the internal telephone to which the call will be sent.

Camped: 221
CALLBACK

The telephone to which you camped a call did not answer the call. The call has come back to you. Press CALLBACK or the line button to reconnect to the call. On the M7100 Telephone, just pick up the receiver.

/Line001 hung UP

A call you camped has come back to you, but the caller hung up before you could reconnect.

Make call first

You have no call to camp. If the call you want to camp is on hold, take it off hold and then camp it.

Not in service
CALLBACK

The telephone to which you have camped a call is out of service or is being used for Configuration or Administration programming. The call has come back to you. Press CALLBACK or the line button to reconnect to the call. On the M7100 Telephone, just pick up the receiver,

Release a call

The line that the camped call is on is in use or that line does not appear at your telephone. Release the line or release an internal line.

Notes

If you use Call Queuing to answer a camped call, external calls are answered before the camped call.

Camped calls appear on a line button on the receiving telephone, if one is available. If not, there is just a message on the display and Camp tones.

Conference

[Feature] 3

Create a conference

You can talk to two people at once.

1. Make sure you have two calls, one active and one on hold.
2. Press [Feature] 3.
3. Take the held call off hold (this is automatic on the M7100 Telephone).

Conference using Privacy

[Feature] 8 3

Normally your calls are private; no one else can pick up your line and join in your conversation. You can turn privacy off for a call allowing another person with the same line to press the-line button and join in your conversation, forming a conference.

1. Press [Feature] 8 3.
2. Tell the other person to press the line button and join your conversation.

Disconnect one party

You can disconnect one party from a conference and continue talking to the other.

1. Press the line button of the call that you want to disconnect. The call that you want to keep is automatically put on hold.
OR
For the M7100 Telephone, press [Feature] # 3, which places one party on hold. Press [Hold] again if necessary, to put on hold the party that you want to keep.
2. Press [Ris]. The call is disconnected.
3. To speak to the remaining party, press the line button of the held call, or for the M7100 Telephone, press [Hold].

Independently hold two calls

For all Norstar telephones except- the M7100 Telephone, you can put the two people on hold independently so that they cannot talk to each other.

1. Press the line button of one person. The other person is automatically put on hold.
2. Press [Hold]. The second person is put on hold.

You can reestablish the conference.

1. Take one call off hold.
2. Enter the Conference feature code.
3. Take the other call off hold.

Put a conference on hold

You can put a conference on hold, allowing the other two people to continue speaking to each other.

1. Press [Hold]. The display shows **Conf on hold**.

You can reconnect to the conference.

1. Press either of the held line buttons, or for the M7100 Telephone, press [Hold]. You are reconnected.

Split a conference

You can talk with one person while the other person is on hold.

1. Press the line button of the person you want to speak to. The other person is automatically put on hold.

OR

For the M7100 Telephone, press , which puts the first party on hold. Press again if necessary to switch parties.

You can reestablish the conference.

1. Press .
2. Take the held call off hold. This is not necessary for the M7100 Telephone.

Related features

Unsupervised Conference

Feature 7 0

You can disconnect yourself from the conference and leave the other two people talking by pressing ((Feature 7 0)). However, if both of the other people are outside the system, there are some restrictions: At least one of the outside callers must have called you and that call must be on a disconnect supervised line.

Displays

You will see some of these displays while using the Conference feature.

3 parties only

You are trying to add a fourth party to your conference call, or to join two conferences together. Release **one** call from the conference before adding another, or keep the two conferences separate.

Access denied

Privacy control cannot be used on internal or conference calls.

Conf. on hold

You have put a conference call on hold.

Conference busy

You have tried to make a conference call, but your system is already handling its maximum number of conference calls.

Line001 221
TRANSFER

You are on a conference with the two lines or telephones shown. You can drop out of the conference and leave the other two parties connected (Unsupervised Conference) by pressing **TRANSFER** or entering the Transfer feature code.

Make calls first

You have tried to set up a conference call, without having made the calls that are to be connected. Make both calls first.

/Make call first

You have tried to use Privacy Control when you are not on a call.

Make second call

You have tried to set 'up a conference call while connected to only one caller. Put your first call on hold, make a second call, and enter the Conference feature code again.

No button FREE

You have put a conference call on hold from your M7100 Telephone, then tried to get another line. Your M7100 Telephone can handle only two lines at a time, and your conference call is using both of them.

Press held line

You have activated the Conference feature with one call active and another on hold. Press the line of the call on hold to bring that person into the conference.

Notes

Only the person who established the conference can process the conference in any of the ways just described.

The Conference feature supports only three people.

If you are using an M7100 Telephone:

- Your conference is connected as soon as you enter the Conference feature code. There is no need to take the second call off hold.
- To split a conference, press # (3). Then, press to change from one caller to the other.
- You cannot independently hold two calls.
- You cannot join an existing two-party call to establish a Privacy conference although you can use the Privacy feature for calls at your telephone.

When a third person joins a conversation on a line that has privacy turned OFF, the call becomes a conference. All the rules applicable to a conference apply except that there is only one-line in use, instead of the normal two. This means that you cannot split a conference set up using Privacy.

In certain situations, you may experience lower volume levels when using the Conference feature with two external calls.

COS Password

Feature 6 8

Change your Class of Service

A Class of Service password is a six digit code that lets you switch from your current Class of Service to one that lets you dial numbers prohibited by your current Class of Service.

1. Press Feature 6 8.
2. Enter your COS password.

Displays

You will see the first of these displays when entering a COS password, you may also see the second.

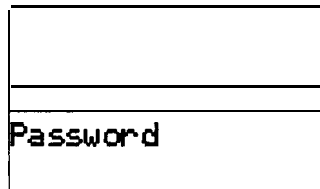

(Blank display) Enter your password. It will not be shown on the display.

You have entered a password that is not programmed into your system.

Notes

If you use your Norstar system from outside the office, you may have to enter a Class of Service password to gain access to the system. Class of Service passwords can give you access to features not available with the regular Class of Service. See **Using Norstar remotely**.

You must enter a Class of Service password each time you wish to make a call using a Class of Service not normally available on your line or telephone.

Norstar allows up to 100 Class of Service Passwords.'

The System Coordinator defines Class of Service passwords in Administration programming.

Customizing your telephone

You can change the way a telephone works in several ways. Some of the following features are assigned to telephones in Administration programming. You can turn other features ON and OFF at individual telephones.

Automatic Handsfree

Automatic Handsfree lets you make or answer a call without having to pick up the receiver or press the **Handsfree** button. The telephone's internal microphone and speaker turn on automatically when you make or answer a call.

The System Coordinator assigns Automatic Handsfree capability to a telephone in Administration programming. Full Handsfree capability must be assigned to a telephone before Automatic Handsfree capability can be assigned to it. This is also done in Administration programming.

This feature is not available on M7100 Telephones.

Contrast Adjustment

Feature * 7

You can set the contrast level of your telephone display.

1. Press **Feature** * 7 .
2. Choose the contrast level you like best. The number of contrast levels available varies from one Norstar telephone to another.

This is the display you will see in Contrast adjustment.

```

Contrast level 2
DOWN  UP   OK
  
```

Press a number for the contrast level you want or press Up or DOWN. Press **Hold** or **OK** to set the new contrast level.

Dialing Modes

You can set the dialing mode of your telephone.

1. Press **[Feature-]** .
2. Choose the dialing mode you want.

Norstar supports three dialing modes; Automatic Dial, Pre-Dial, and Standard Dial. All three modes support on-hook dialing. (On-hook dialing means dialing a call without picking up the receiver.) The special features of the Automatic and Pre-Dial modes are available only when you dial on-hook.

The Dialing Modes feature code cannot be programmed onto a memory button.

Standard Dial

In Standard Dial mode, you make a call by selecting a line and dialing the number. If you have a Prime line, it is selected automatically when you lift the receiver or press .

Standard Dial does not support on-hook dialing on an M7100 Telephone. If you have an M7100 Telephone, use the Automatic Dial or Pre-Dial feature for on-hook dialing.

Automatic Dial

If you have a Prime line assigned to your telephone, Automatic Dial allows you to dial a number without selecting a line. Your Prime line is selected as soon as you start dialing a number. Automatic Dial does not work if your Prime line is in use.

Telephones connected to an Analog Terminal Adapter (ATA) cannot use Automatic Dialing.

Pre-Dial

Pre-Dial allows you to enter a telephone number, check it, then change it before actually making the call. The call is not dialed until you select a line or line pool, or pick up the receiver.

You can pre-dial both external and internal numbers. You must, however, select the correct type of line (external or internal) for the type of number you have entered.

If all the lines on your telephone are busy, you will not be able to enter a telephone number.

If your telephone starts ringing while you are pre-dialing a number, you can stop the ringing by turning on Do Not Disturb ([Feature] 8 5). This does not affect numbers you are entering.

This is the display you will see when selecting a Dial mode.

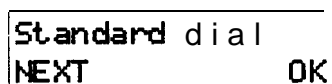

The current dial mode is shown. Press # or NEXT until the dial mode you want appears. Press Hold or OK to select the displayed dial mode. If Automatic Dial is not available it is because you have no Prime line.

Language Choice

English

[Feature] * 5 0 1

You can select English as the language of your telephone display.

1. Press [Feature] * 5 0 1.

Alternate Language

[Feature] * 5 0 2

You can select the alternate language as the language of your telephone display.

1. Press [Feature] * 5 0 2.

Each Norstar system supports English and one alternate language. Norstar systems are available with either French or Spanish as the alternate language. Button caps are available in both alternate languages.

You can select either English or the alternate language at each telephone. When your system is first installed, all telephones will use English.

You can program a memory button for one-touch switching between languages. Program **Feature** * 5 0 1 onto the button. Pressing the button will switch you back and forth between English and the alternate language.

Feature * 5 0 (2 cannot be programmed onto a memory button).

One of the following displays will appear when you enter a language choice feature code.

En français...	Telephone display messages will be in French.
En español...	Telephone display messages will be in Spanish.
In English...	Telephone display messages will-be in English.

Move Line buttons

Feature * 8 1

You can move external lines to different buttons on your telephone. You can use this feature to arrange your lines in the way that makes the most sense to you.

1. Press **Feature** * 8 1 .
2. Press the button you want to move the line from.
3. Press the button you want to move the line to.

You will see some of these displays while moving lines.

Inval id location/	You have tried to move a line to a button that cannot be used as a line button, such as a Handsfree/Mute button, or an Answer button.
Move line from: QUIT	Press the button of the line you want to move. Press QUIT or Feature when you have finished moving lines.

Move line to:
QUIT

Press the button you want to move the line to. Neither of the buttons is erased. The lines, or the line and feature,, simply switch places.

Press a line

The button you are trying to move is not a line button. If you are trying to switch a line and a feature, move the line to the feature button and not vice versa.

Pulse/Tone Dialing

Each external line is set to either pulse or tone dialing. Pulse dialing is the traditional method of dialing used by rotary dial or push button single-line telephones. Tone dialing allows telephones to communicate with other devices such as answering machines. Tone dialing is required to access the features that PBX systems may offer or to use another Norstar system remotely. (For more information, see the section Using Norstar remotely).

Your Installer sets your lines to pulse or tone dialing in Configuration programming.

To switch from pulse to tone dialing

#

If your external lines are programmed for pulse dialing, you can switch your telephone temporarily to tone dialing.

1. Press **Q** while on an active line. Once you hang up, your telephone returns to pulse dialing.

Ring Type

[Feature] * 6

You can choose one of four distinctive rings for your telephone. This makes it easier to identify your telephone in an open office.

1. Press [Feature] * 6

This is the display you will see when choosing a ring type.

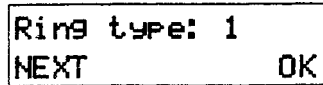

Press , , , or NEXT. You hear the selected ring for two seconds. Repeat until you hear the ring you prefer, then press or OK.

Ring Volume



You can set the volume at which your telephone rings.

1. Press . The telephone will ring.
2. Press to adjust the volume.

This is the display you will see while setting Ring volume.

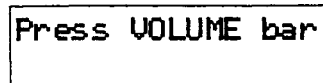

Press either side of the volume bar () to adjust the volume.

Telephone Administration Lock

Telephone Administration Lock limits the ways in which you can customize your telephone. There are three types of Telephone Administration Lock: Full, Partial, and None.

Full Administration Lock lets you change the contrast of your telephone's display, use Ring Type, Ring Volume and Button Inquiry, and control the volume of your speaker.

Partial Administration Lock allows you to forward your calls, turn on Do Not Disturb and Service Modes, and use the Background Music, Send Message, Ring Again, Privacy, and Trunk Answer features.

None (No Administration Lock) allows you to access all features that are programmed for your telephone. The System; Coordinator assigns Administration Lock to each telephone in Administration programming.

Telephone Administration Lock does not affect call handling features.

Related features

Autodial

Feature * 1 / Feature * 2

You can program your telephone's memory buttons to dial frequently used numbers with the Autodial feature.

Feature programming

Feature * 3

You can program feature codes onto your telephone's memory buttons using the Feature programming feature.

Speed Dial programming

Feature | 4

You can program personal speed dial numbers onto speed dial codes 71 to 94 using the Personal Speed Dial programming feature.

Dialing

One of the most important features of your telephone system is the ability to dial telephone numbers. Many features require you to dial telephone numbers. The displays associated with dialing are listed here.

Direct-dial

You can dial a Direct-dial telephone with a single digit. The Direct-dial telephone is usually in a central location, such as a receptionist's or secretary's desk. It is usually a Prime telephone and a Central Answering Position (CAP).

External line access code

The external line access code is the number you dial to get an external line. You will need to use an external line access code if your Prime line is an internal line. The code will connect you to a line pool through your internal line.

If your Prime line is an external line, or if you select an external line on your telephone, you will not need an external line access code. You will always need an external line access code on an M7100 Telephone.

Your Installer assigns the external line access code in Configuration programming.

Last Number Redial

[5] ture

- You can redial the last external number you' dialed.

1. Press [Feature] [5].

Ring Again

Feature [2]

If you can't get through to someone on your Norstar system because their telephone is busy or there is no answer, you can have the Norstar system tell you when they hang up or next use their phone.

1. Press [Feature] [2] before you hang up.

You can also use Ring Again to tell you when a busy line pool becomes available.

Using Ring Again cancels any previous Ring Again requests at your telephone.

Cancel Ring Again [Feature] # 2

You can cancel a ring again request by entering the Cancel Ring Again feature code.

Saved Number Redial [Feature] 6 7

You can save the number of the external call you are on (providing you dialed the call) so that you can call it again later.

1. Press [Feature] 6 7 while you are still on the call.

You can dial a saved number.

1. Press [Feature] 6 7 when you are not on a call.

Related features

Autodial [Feature] * 1 / [Feature] * 2

The autodial feature lets you program telephone numbers onto memory buttons for one-touch dialing.

Dialing modes [Feature] * 8 2

Norstar supports three different methods of dialing. They are described in the Customizing your telephone section under the heading Dialing Modes.

Line Pools

Line pools give you access to many external lines.

Priority Call [Feature] 6 9

If you get a busy signal when you call someone in your office, you can interrupt them using Priority Call.



Speed Dial [Feature] 0

The Speed Dial feature lets you dial programmed numbers by entering speed dial codes.

Displays

You will see some of these displays while selecting lines and dialing telephone numbers and in response to the numbers you dial.

```
9_
QUIT BKSP
```

You are dialing using Pre-Dial. To erase an incorrect digit, press **BKSP** or ⇒  . When the number is complete, select a line or lift the receiver.

```
221 busy
PRIORITY LATER
```

The telephone you have called has no internal lines available. You may press **LATER** to use the Ring Again or Message features or press **PRIORITY** to make a Priority Call.

```
95551234
TRANSFER
```

This prompt remains on your display as long as you are on a call you have dialed. You may transfer the call by pressing **TRANSFER**.

```
Already joined
```

Your telephone is already connected to the telephone you are trying to call. Check your active line buttons, and return to that call.

```
Calling 221
LRTER
```

Wait for the telephone to be answered, or press **LATER** to use the Ring Again or Messages features.

```
Calling 221
PRIORITY LATER
```

Wait for the telephone to be answered. If no one answers, you may press **LATER** to use the Ring Again or Messages features, or press **PRIORITY** to make a Priority Call.

```
/Can't ring again
```

You cannot use Ring Again on your current call. You can only use Ring Again while you have a busy signal on an internal call or line pool request or while an internal call is ringing.

Do not disturb
PRIORITY LATER

The telephone you are calling is in Do Not Disturb mode. Press **LATER** to use the Ring Again or Messages features, or press **PRIORITY** to make a Priority Call.

In use: 221

The line you have chosen is in use at another telephone. Use a different line, or wait until the line is free.

Invalid id number

You have entered a number that does not exist.

Line denied

You have attempted to use someone else's private line.

Line in use

The line you have chosen is in use. Try another. If the line remains in use and never seems to clear, it may be hung. See Lines in the System Features section for information on hung lines.

Line001
TRANSFER

Enter the digits of the number you want to dial.

No button free

You have tried to make or receive a call when no line button was available.

No last. number

You have not dialed an external telephone number since the last power interruption or system reset.

No line selected

Either you have no Prime line or your Prime line is busy. Select a line manually before dialing.

No number saved

You have tried to save the number of an incoming call. You can only save numbers that you have dialed yourself.

No saved number

You have tried to use Saved Number Redial, but have not first saved a telephone number. The Saved Number Redial memory is empty.

Not in service

You have entered the number of a telephone that is not in service.

On another call
LATER

The telephone you have called is on another call. Press **LATER** to use the Ring Again or Message features.

Restricted call

The call you are trying to make is not allowed for your Class of Service. Make your call on a line or telephone that is not restricted, or use a Class of Service password to bypass the restriction.

Ring Again?
YES NO EXIT

Press **YES** to use Ring Again. Press **NO** if you prefer to send a message. See Message and Ring Again.

Select a line

Either you have no Prime line, or the Prime line is in use, or the line programmed onto an Autodialer, Speed Dialer, or Hotline is in use. Select a line and dial again.

Send message?
YES NO

Press **YES** to send a message. See Messages.

Your number

You have dialed your own number.

Notes

The maximum number of digits that Last Number Redial or Saved Number Redial records is 24.

You can copy the telephone number from a Last Number Redial or Saved Number Redial button onto an **Autodial** button. Simply enter the Last Number Redial or Saved Number Redial feature code when the **Autodial** feature asks you to enter a number.

Each telephone can save only one number at a time with Saved Number Redial, not one number for each line.

Do Not Disturb

Feature 8 5

Do Not Disturb

You can stop calls from ringing at your telephone.

1. Press Feature 8 5.

Only Priority Calls will ring at your telephone. A line button will flash when you receive a call, but the call will not ring..

You can refuse to answer a particular call (including a Priority Call).

1. Press Feature 8 5 while your telephone is ringing.

Cancel Do Not Disturb

Feature # 8 5

You can cancel Do Not Disturb.

1. Press Feature # 8 5.

Displays

Do not. disturb

Your telephone is in Do Not Disturb mode. To cancel Do Not Disturb, press Feature # 8 5.

Allow calls

Your telephone is receiving calls normally.

Notes

If you use Do Not Disturb while an external call is ringing, the call will be forwarded to the Prime telephone. It may also be answered by anyone whose telephone shares the line it is on. Once you turn Do Not Disturb on, calls will be forwarded to the Prime telephone only if there is no other telephone on which the line appears. (The Delayed Ring Transfer feature transfers all unanswered calls to the Prime telephone after a specified time.)

Feature Programming.

Feature * 3

Program a button

You can program a feature code onto a memory button.

1. Press Feature * 3 .
2. For all telephones other than the M7100 Telephone, select the button you want to program.
3. Enter the feature code you want to program onto the button.

Erase a button

Feature * 1

You can erase a memory button.

1. Press Feature * Q . This is actually the External Autodial feature code.
2. For all telephones other than the M7100 Telephone, select the button you want to erase.,
3. Erase the button by pressing **OK** or Hold .

You cannot erase Answer, Handsfree/Mute, Intercom, or line buttons.

Button inquiry

Feature * 0

You can check the function of any line, Intercom, or memory button on your Norstar telephone.

1. Press Feature * 0 .
2. For all telephones other than the M7100 Telephone, press the button you want to know about.
3. Read the display.

When you are labeling or replacing a button cap, activate Button Inquiry so that you won't accidentally activate a feature.

Displays

You will see some of the following displays while programming, erasing, or checking buttons. A variety of displays appear in Button Inquiry. See the display <Feature name> for information applicable to these displays.

```
1234567890123...
      VIEW→  OK
```

Press **#** to move either right or left, or press **VIEW→** or **←VIEW** to view a number that is too long to fit on the display. Press **[Hold]** or **OK** when you are finished.

```
<Feature name>
      SHOW  OK
```

The name of the feature assigned to a button is displayed when you press the button. **SHOW** appears when there is more information available. Press **#** or **SHOW** for additional information.

```
Enter code:
      .
```

If you are checking a Speed Dial button, enter the two-digit Speed Dial code that you want to check.

```
(Enter Digits
```

To erase a button, press **[Hold]**.

```
F_
QUIT CLEAR
```

While entering a feature code you can press **[Feature]** or **QUIT** to quit programming or **CLEAR** to clear out the characters you have entered. The system will accept the entry as soon as you enter a valid feature code.

```
Feature code:
QUIT
```

Press **[Feature]** and enter the feature code you want to program onto the button. Invalid codes cannot be entered.

```
Feature moved
```

You have programmed a button with a feature that was already programmed onto another button. The feature has moved to the button you just programmed. Its original button is blank.

```
Hold or release
```

You cannot program an autodialer or feature button while you are on a call.

Press a button
EXIT

Press the button you want to check.
Press or EXIT when you
are finished.

Program and HOLD

To erase a button, press .

Program and OK
QUIT OK

To erase a button, press or
press OK.

Release c a l l s

You have tried to use Button Inquiry
while you were on a call or had calls
on hold.

Notes

When this book tells you to enter a feature code, you can do so by pressing a memory button programmed with that feature code. In some cases, pressing the button a second time cancels the feature.

On the M7100 Telephone, Button inquiry shows your internal number followed by the function assigned to your single memory button.

Any memory button not programmed as an external or internal line, target line, Answer button, or Handsfree/Mute button, is available for programming features.

The following feature codes cannot be programmed onto a memory button: Long Tones and any code beginning with except Language Choice and Contrast Adjustment.

Group Listen

Feature

Group Listen

You can let people in your office listen in on a call.

1. Press . You will hear the caller's voice through your telephone's speaker.
2. Continue to speak to the caller through the telephone receiver. The caller will not hear people in your office.

Cancel Group Listen

Feature

You can cancel Group Listen for the current call.

1. Press .

Group Listen is canceled automatically when you hang up the Group Listen call.

Displays

You may see one of these displays with Group Listen.

Make call first

You have tried to use Group Listen when you are not on a call.

Pick up receiver

You have tried to use Group Listen without picking up the receiver.

Notes

Keep the receiver away from the speaker, or you may hear feedback. The higher the volume, the more the feedback. Press the button to prevent feedback when hanging up.

You can switch a Group Listen call to Handsfree by pressing . To switch back to Group Listen, enter the Group Listen feature code again.

Handsfree/Mute

Handsfree

Make calls without lifting the receiver

You can make calls without lifting the receiver. However, you must have a Prime line assigned to your telephone.

1. Press

Handsfree

. The telephone's internal microphone and speaker are automatically turned on.
2. Dial your call.
3. Speak normally.

Answer calls without lifting the receiver

You can answer calls without lifting the receiver.

1. When your telephone rings, press

Handsfree

. The telephone's internal microphone and speaker are automatically turned on if you have a Prime line assigned to your telephone.
2. Speak normally.

Mute Handsfree

You can switch off the telephone microphone so that you can speak privately to someone in your office while you are on a handsfree call.

1. Press

Handsfree

. The microphone is turned off.

You can turn the microphone back on again and continue your handsfree call.

1. Press

Handsfree

.

Regular call to Handsfree

You can turn any regular call into a handsfree call.

1. Press

Handsfree

 and hang up the receiver.

Handsfree to regular call

You can turn a handsfree call into a regular call.

1. Lift the receiver.

Notes

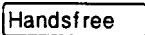
The indicator next to  is solid when you are in Handsfree mode. It flashes when you mute the microphone.

In open-concept environments, use the receiver or a headset when Handsfree communication is not necessary, or when you need privacy during a call. Always tell the person you are speaking to that you are using Handsfree, and let them know who else is listening to the conversation.

Direct your voice toward the telephone. The closer you are to the telephone, the easier it is for the microphone to transmit your voice clearly to your listener.

Wait for your caller to finish speaking before you speak. The microphone and speaker cannot both be on at once. Your caller's voice may be cut off if you both speak at the same time. Noises such as a tapping pencil could be loud enough to turn on your microphone and cut off your caller's speech.

To prevent a possible echo, keep the area around your telephone free of paper and other objects that might screen your microphone. Turning down the microphone's volume (using ) also prevents echo.

Place the telephone so that any unavoidable local noise (such as an air conditioner) is behind it. This limits the amount of disruptive background noise.

A Handsfree button is assigned to a telephone by the System Coordinator in Administration programming.

The Handsfree/Mute feature is not available on M7100 Telephones.

Hold

Hold

Put a call on hold

You can temporarily suspend a call.

1. Press [Hold].

When a call is on hold, its indicator flashes on all telephones that have access to the line. The call can be retrieved from any of these telephones.

Retrieve a held call

You can connect to a call on hold.

1. Press the flashing line button of the held call.

Automatic Hold

You can switch from one call to another.

1. Press the line button of the caller you want to speak to. Your current caller is put on hold automatically.

Listen **on** Hold

If you have been put on hold, you can hang up the receiver while you wait for the other person to return.

1. Press [Hold].
2. Hang up the receiver.
3. Press the line button of the call. You may hear indications from the far end that you are on hold (for example, tones or music).
4. When the person you were talking to returns you will hear them through your telephone speaker. Lift the receiver and talk.

Exclusive Hold

Feature 7 9 **or**Feature Hold

You can put a call on Exclusive Hold so that it can be retrieved only at your telephone.

1. Press [Feature] 7 9 or [Feature] Hold . The line appears busy on all other telephones, and the call cannot be picked up by anyone else in the office.

Music/Tones/Silence on Hold

External callers can hear either music, a periodic tone, or silence while they are on hold. In order for your caller to hear music, your company must have installed a music source.

WARNING

In accordance with U.S. copyright law, a license may be required from the American Society of Composers, Authors and Publishers, or a similar organization, if radio or TV broadcasts are transmitted through the Music on Hold feature of this telecommunication system.

Northern Telecom Inc. hereby disclaims any liability arising out of the failure to obtain such a license.

Your Installer sets this feature to music, tones, or silence in Configuration programming.

Notes

On the M7100 Telephone, [Hold] alternates between two lines; one active, one on hold. The M7100 Telephone cannot retrieve a call placed on hold by another telephone.

If the Automatic Handsfree feature has been assigned to your telephone, use the Handsfree/Mute feature instead of Listen on Hold.

Host System Signaling

You can access Host systems, such as Private Branch Exchanges (PBX) from Norstar by using Host System Signaling features (also known as End-to-End Signaling). These features either send a special signal to the host system or allow you to program delays required by host systems onto external Autodial buttons or Speed Dial codes.

Host system' signaling codes

Link

Feature 7 1

If your Norstar system is connected to a Private Branch Exchange (PBX), you can use a Link signal to access special features.

The Link signal can also be included as part of a longer stored sequence on an External **Autodial** button or in a Speed Dial code. The Link symbol () uses two of the 24 spaces in a dialing sequence.

Pause

Feature 7 8

The Pause feature enters a 1.5 second delay in a dialing sequence on an external line. This is often required for signaling remote devices, such as answering machines, or when reaching through to PBX features or Host systems.

You can obtain a Pause with one button press if you program the feature code onto a memory button. More than one Pause can be programmed onto an External **Autodial** button.

The Pause symbol () uses one of the 24 spaces in a dialing sequence.

For Pulse Dialing, * inserts a 1.5 second pause into the dialing sequence.

Programmed Release

Feature * 8 9

The Programmed Release feature performs the function of the Ris button in a programmed dialing sequence. When the system encounters Programmed Release in a programmed dialing sequence, it stops dialing and hangs up the call. The Programmed Release symbol () takes up two of the 24 spaces in a programmed dialing sequence.

Run/Stop

Feature * 9

Run/Stop inserts a break point into a sequence of dialed numbers or characters used for automatic dialing. This may be necessary when you are connecting to a PBX or similar Host system.

For example, you may call a company with an automated attendant that instructs you to dial the internal number you need. You can program the company number, a Run/Stop, then the internal number on one External **Autodial** button. Press the autodialer once to dial the company number. When you hear the automated attendant, press the autodialer again to dial the internal number.

The Run/Stop symbol (S) uses one of the 24 spaces in an External **Autodial** or Speed Dial sequence.

Timed Release

Feature 7 2

The Timed Release feature inserts a 1.5 second pause into a sequence. You can use it in a dialing sequence for accessing a remote system, such as a PBX. You can also dial it if you wish to release a call from your line but keep the line for another call. You will return to dial tone.

The Timed Release symbol () takes up two of the spaces in a programmed dialing sequence.

Displays

You may see this display while entering Host System Signaling codes.



Invalid code

You have entered a code that can only be used in a programmed **Autodial** or **Speed Dial** sequence, not on a call you dial directly. Programmed **Release** and **Run/Stop** are for use in programmed dialing sequences only.

Notes

If your external telephone lines are programmed for Pulse Dialing, you can temporarily switch to Tone Dialing by pressing **Q** after selecting the line. Tone Dialing lets your **Norstar** telephone communicate with devices and services that respond to tone signals, such as automatic switchboards, and fax or answering machines.

Line Pools

[Feature] 6 4

Use a line pool

A line pool is a group of external lines that can be shared by many telephones. You can use a line in a line pool to make an external call.

1. If you have a free internal line, dial a line pool access code on an internal line. (You do not need the Line Pool feature code.) If you have no free internal line, press **Feature** 6 4 and then a line pool access code.

Everyone in the office should have a list of the line pool access codes for the line pools their telephones can use.

Displays

You may see some of the following displays while using a line pool. For displays associated with dialing telephone numbers, see the Dialing section.

Code:

Enter a line pool access code.

Denied i n admin

Access to the line pool you requested is denied in Configuration programming.

Inval id code

You have entered an invalid line pool access code.

Line in use

The line chosen by the system for your line pool request became active before connecting with your call. Retry the line pool request.

No button free

There is no free button on which the line pool line can appear.

No free l ines

You have tried to access your line pool, but there are no lines in the line pool or all the lines are busy. Use Ring Again or call again later.

Notes

You do not usually need to enter the Line Pool feature code to use a line pool. Simply dial the line pool access code on an internal line. If you have no free internal lines, you will need to use the feature code to get a line pool. You will also need it to program access to a specific line pool onto a memory button.

You can program a button to access a line pool by programming the Line Pool feature code and a line pool access code onto a memory button in Feature programming (*). When all the lines in a line pool are busy, the indicator for the Line Pool button turns on. The indicator turns off when a line becomes available.

Your Norstar system can have 15 line pools, and a telephone can be programmed to access any number of them.

You can use a line pool only to make external calls.

If no lines are available in the line pool, you can use Ring Again at the busy tone. You will be notified when a line in the line pool becomes available. See Ring Again.

Your Installer gives telephones access to line pools in Configuration programming. Each line pool is assigned a line pool access code in Configuration programming.

Line Redirection

Feature 8 4

Redirect a line

Line Redirection lets you send your external calls to a telephone outside the office. You may choose to redirect all your external lines or only some of them.

1. Press .
2. Select the outgoing line to be used for redirected calls.
3. Enter the number to which calls will be redirected. ---
4. Select the lines to be redirected.

Cancel Line Redirection

Feature # 8 4

You can cancel Line Redirection.

1. Press .
2. Select the lines for which redirection is to be canceled.

Related features

Call forward

4 ture

Note the differences between Line Redirection and Call Forward. Call Forward forwards all calls that arrive at a particular telephone to another telephone within the **Norstar** system. Line redirection redirects only the lines you specify, no matter which telephones they appear on, to a telephone outside the **Norstar** system. Line Redirection takes precedence over Call Forward.

Displays while redirecting lines

You will see some of the following displays while programming Line Redirection. The displays you see while canceling redirection are listed after this chart. See the Dialing section for displays that occur while entering telephone numbers.

9_
QUIT BKSP OK

Continue entering digits. Press **BKSP** or to delete incorrect digits. Press **OK** or when you are finished.

Access denied

You cannot perform line redirection on an M7100 Telephone.

Denied in admin

Line Redirection is not allowed on your telephone. To allow Line Redirection, the Allow Redirect parameter must be set to Y(Yes).

Enter digits
QUIT OK

Enter the telephone number to which you wish to redirect calls using one of the following methods:

- Press an External **Autodial** button.
- Enter an external telephone number of no more than 24 digits. Then, press **Hold** or **OK**.
- Press **Hold** or **OK** if, the line you have chosen as the outgoing line is a private network line that does not require you to dial digits.

In use: 221

You have tried to program redirection while someone else is programming redirection. Only one person can program line redirection at a time.

Incoming only

The line you are trying to use for redirecting calls is for incoming calls only. Choose an outgoing line.

Line Redirection
QUIT ADD REMOVE

Press ***** or the **ADD** button to begin redirection. Press **REMOVE** or **#** to cancel a previous redirection.

No line to use

You have one external line on your telephone, but you need a second line to perform line redirection. Redirect your external line using a line **pool** as the outgoing line.

Outgoing line

You are attempting to redirect a line and the line you have chosen is the outgoing line you have selected as a destination. You cannot redirect a line to itself. Select another line.

Pool code: _
QUIT

Enter a valid line pool access code.

Programmed

This message appears when you have successfully redirected a line or successfully canceled redirection of a line.

Redir by 221
OVERRIDE

You have attempted to redirect a line, but someone else has already redirected that line. You may press OVERRIDE or to override the previous redirection and redirect the line as you wish.

Restricted call

The destination you have chosen for line redirection is restricted.

Select line out
QUIT

Select the line that will be used to redirect calls out of the system, using one of the following methods:

- Press an external line button.
- Press an internal line button and dial a line pool access code.
- Press a line pool memory button.
- Press an External **Autodial** button.

Select line(s)
QUIT RLL

Press the lines that are to be redirected. To deselect a line, press it again. You may press ALL to redirect all your lines.

Select line(s)
ALL OK

Continue to press the lines that are to be redirected. Press OK or when you are finished.

Unequipped line

The line you are attempting to redirect cannot be redirected because the hardware does not support redirection.

Displays while canceling redirection

You will see the following displays while canceling Line Redirection.

```
Redir by 221
OVERRIDE
```

This line is redirected by someone else. Press **OVERRIDE** or ***** to cancel redirection of the line.

```
Select line(s)
QUIT ALL
```

Press the lines that are no longer to be redirected. The lines light up as you press them. Once you cancel redirection for a line you cannot restore it by pressing the line again. You may press **ALL** to cancel redirection for all your lines. When you are finished, press **OK** or **Hold**.

```
Select line(s)
ALL OK
```

Continue to press the lines that are no longer to be redirected. Press **OK** or **Hold** when you are finished.

Notes

You can answer the telephone if it rings while you are in the middle of programming Line Redirection, but none of the Norstar call handling features will be available until the feature times out. If you need to use a Norstar feature to process the call, you must quit Line Redirection programming by pressing the **Feature** button. Do not press **Ris** or you will disconnect the call you are trying to process.

While you are programming Line Redirection you will not receive any indication of calls that do not actually ring at your telephone.

The system does not check that the number you give for Line Redirection is a valid one. If you redirect to an invalid number, redirection will fail. Using an Autodialer to enter the redirection number helps avoid this possibility. An Autodialer used for line redirection must have a specific line programmed onto it.

If you use the **ALL** button to redirect all your lines, it is important that you wait until all the lines on your telephone light up before pressing or **OK**. If you press or **OK** before all the lines light up, those lines not lit will not be redirected.

Be aware of the consequences of redirecting your lines. If you redirect your target line to your home, for instance, and someone calls you from home, they will get a busy signal when the system tries to call the telephone they are using. Companies with offices in different time zones should avoid situations in which the lines from the eastern office are redirected to the west and those from the west are redirected to the east. This could result in a costly long distance redirection loop.

The system can be set up so that redirected calls give a brief ring on telephones in the **Norstar** system as they are redirected. These calls cannot be answered within the system until you cancel redirection.

The line chosen for redirecting calls on other lines can still be used normally when it is not busy on a redirected call. To avoid redirection failing because the chosen line is in use, choose a line pool with several lines in it.

In certain situations, callers may experience lower volume levels when you use Selective Line Redirection to an external location.

Long Tones

Feature 8 0 8

Use long tones

The Long Tones feature lets you control the length of a tone so that you can signal devices such as fax or answering machines which require tones longer than the standard 120 milliseconds.

1. While on a call, press **Feature 8 0 8**.
2. Press the dial pad buttons to produce the appropriate tones. Each tone will sound for as long as you hold down the button.

Displays

You will see some of the following displays while using Long Tones.

Long Tones:

At the appropriate time, press any dial pad button. Hold each button down for as long as necessary. You can cancel Long Tones by pressing **Feature** or **.old**.

/Make call first

You have tried to use Long Tones when you are not on a call.

Tones denied

The person you are calling has pressed **Hold**, canceling your long tones.

Notes

Long Tones can be used on any call except a conference call. You can use internal lines of the Norstar system to activate a device connected to an Analog Terminal Adapter (ATA) in another area of your office; or external lines to access devices outside the Norstar system.

Messages

The Messages feature allows you to leave a message on the display of another Norstar telephone, and lets you know if you have any messages waiting. The Messages feature uses a Message Waiting List to keep a record of your internal messages and your (external) voice mail messages (if you subscribe to a Voice Message service with visual Message Waiting Indication). From your Message Waiting List, you can:

- view your messages,
- call back the internal caller who left a message,
- erase an internal message,
- call your Voice Message Center that left a message(s), and,
- clear a message sent by your Voice Message Center (the message still remains at the Center until it is erased there).

Send a message [Feature] 9

You can leave a message on the display of another telephone in your Norstar system.

1. Press Feature 1.
2. A one-line display shows **Message to:**
OR
A two-line display shows **Message 1 ist.** Press **ADD** to display **Message to:**
3. Enter the internal number that is to receive your message.
OR
Press an internal **Autodial** button.
4. Your recipient's display identifies that the message has arrived.

Show your sent messages [Feature] 1

On a telephone with a two-line display, you can show and scan the messages you have sent.

1. Press [Feature] 1. The display shows **Message 1 ist.**

2. Press **SHOW** to display your first sent message.

Cancel a sent message

Feature [] # [] 1 []

You can cancel a message that you have sent to someone.

1. Press [Feature] [] # [] 1 []. The display shows **Cancel** :
2. Enter the internal number for the message that you want to cancel.

Notification of message(s)

If another user in your Norstar system or your Voice Message Center has sent you a message, your display reads **Message** for YOU or **Messages** for YOU. If you also have items in your Call Log, your display reads **Messages & Call s**.

Enter your Message Waiting List

Feature [] 6 [] 5 []

To enter your Message Waiting List:

1. Press [Feature] [] 6 [] 5 []. The display shows the first item.

Navigate through your Message Waiting List

To navigate forward through your list, press **NEXT** or [] # []. To navigate backward, press [] * [].

Call from your Message Waiting List

From your Message Waiting List, you can call the person (or your Voice Message Service) who sent the message. First, you may want to view your messages and decide if you want to reply to them.

1. Press (Feature) [] 6 [] 5 []. The display shows the first message.
2. Press **NEXT** or [] # [] to scroll through the list of messages.
3. To call a particular number, press **CALL or Q** []. The telephone number that is dialed to access your Voice Message Center is programmed in Administration programming. This telephone number is dialed automatically when you press **CALL or Q** [].

If you wish to use a line other than the programmed line, exit from the Message Waiting List and dial the Voice Message Center telephone number using normal dialing methods.

Remove items from your List

Feature # 6 5

You can erase an internal message or clear a message you have received from your Voice Message Center. When you clear this message from your Message Waiting List, it still exists at your Voice Message Center until you erase it there. To erase a voice message, refer to your Voice Message Center documentation.

1. From an idle telephone, press Feature # 6 5 a s e or clear the first message (either an internal message or a message from your Voice Message Center).

OR

From within your Message Waiting List, press CLEAR or ERASE or Hold for the item that you want to remove.

Related features

Call Log

The status display for the Message Waiting List shares the same display with the Call Log status display.

Displays

You will see some of the following displays while sending messages.

1.221
NEXT ERASE EXIT

When reviewing the messages you have sent, press NEXT to view the next message or ERASE to erase the message on the display.

221 called
NEXT CALL ERASE

This is the Message Waiting List display for internal messages. Press NEXT to see the next message. Press CALL to reply to the message. Press ERASE to erase the message.

Can't send, ms9

You have tried to send a message to a **Norstar** Analog Terminal Adapter. The **Norstar** Analog Terminal Adapter does not have a display so it cannot show a message.

Cancel denied

You have entered an invalid number when attempting to cancel a message.

Cancel for:

Dial the internal number to which you sent the message you wish to cancel.

Cleared>LINENAM
NEXT

You have cleared an external message from your Message Waiting List. The message itself still exists in your Voice Message Center until you erase it there.

Erased> 221
NEXT

You have erased an internal message.

Hold or release

This message does not pertain to M7100 Telephones. If you try to access your Message Waiting List while on an active call, this display advises you to hold or release the present call.

In use: 221

You are trying to call from your Message Waiting List. The line that you are trying to use is being used by the identified **Norstar** user.

L01:LINENAM UM59
NEXT CALL CLEAR

This is the Message Waiting List display. For that particular voice message, it tells you the line the call came in on, and the name of that line.

Message denied

You have tried to send a message to an invalid internal number or to a telephone that is out of service.

Message for you
MSG

You have a one item in your Message Waiting List, and you have no new entries in your Call Log. Press **MSG** to review the message.

Message list
SHOW ADD EXIT

The **SHOW** display button appears only if you have outstanding messages. Press **SHOW** to review or erase messages you have sent. Press **ADD** to send a new message.

Message to:

Enter the internal number of the telephone to which you would like to send a message.

Messages & Calls
MSG CALLS

This indicates that there is more than one item in your Message Waiting List, and there are one or more new entries in the Call Log.

Messages for you
MSG

You have more than one item in your Message Waiting List, and you have no new entries in your Call Log. Press **MSG** to review the messages.

No button free

You have no line button free with which to reply to a message.

No messages

You don't have any messages to cancel or there are no messages to scan through.

No number stored

There has been no number programmed for the Voice Message Center. To program the number, see the Programming chapter.

Release calls

If you have an M7100 Telephone, this is displayed when you try to reply to a message while on an active call. You must release your call before entering your Message Waiting List.

Their list full

You are trying to send a message to a telephone whose message waiting list is full.

Your list full

You have tried to send a message but your telephone's list of sent messages is full. Cancel one of the messages you have sent, if possible, or wait until you have received a reply to one of those messages.

Notes

You can send up to four messages to different telephones, including your Voice Message Center. If your telephone is a Direct-dial telephone or a Central Answering Position, you can send messages to 30 telephones.

You can receive up to four messages from different telephones, including your Voice Message Center. The single message from your Voice Message Center may pertain to several voice messages.

Any message can be canceled either by the person who sent it or by the person who received it.

If your reply to a message is forwarded or is answered at another telephone using the Call Pickup feature, the message remains on your telephone until you cancel it or successfully contact the telephone that sent the message.

Norstar Telephones

This section covers the basic features of your Norstar telephone and optional equipment that may be attached to it.

Buttons

, Feature button

Feature

You use the Feature button to invoke Norstar features. See the Using Norstar features section.

Hold button

Hold

You use the Hold button to put calls on hold. See the Hold section. It is also used in place of the OK display button on telephones with one-line displays.

Memory buttons

Memory buttons are the buttons with indicators on the M7208, M7310, and M7324 Telephones, and the dual buttons without indicators on the M7310 Telephone. There is also a single memory button, without an indicator, on the M7100 Telephone. Memory buttons can be used for any of the following buttons, except that lines and Answer buttons must appear on buttons with indicators.

Answer buttons

You can use an Answer button to monitor calls on another person's telephone. All calls to the monitored telephone appear on the Answer button. Such calls may also ring at the telephone with the Answer button, depending on how the system is configured. Answer buttons are most useful for a secretary who monitors incoming calls for one or several managers.

If more than one call is ringing at the manager's telephone, the first call appears on the secretary's Answer button. Any subsequent calls appear on Intercom buttons if they are available.

More than one secretary may have an Answer button for a single manager. This allows two or more secretaries to handle calls for a busy manager.

Similarly, one person can handle calls for up to four other people, using separate Answer buttons for each person.

A secretary's telephone should have a memory button with an indicator programmed as the Internal Autodial button for the manager's telephone. This allows the secretary to call the manager and to deal efficiently with incoming calls.

You cannot make calls using Answer buttons.

Autodial buttons

Autodial buttons let you dial numbers by pressing a single button. See the Autodial section.

Line buttons



You have one line button for each line assigned to your telephone. You press the line button to select the line you want to answer or use to make a call. Having several line buttons allows you immediate access to more than one line so you can handle and monitor calls easily. The M7100 Telephone does not have line buttons and can have a maximum of two lines. You can switch between its two lines, one active and one on hold, by pressing [H o l d].

Programmed Feature Buttons

Programmed feature buttons allow you to invoke Norstar features by pressing a single button. See the Feature Programming section.

Release button

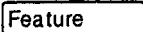

Pressing  ends a call. You do not have to put the receiver down.  also ends feature programming.

While you are on a call, do not press  to end a feature you are using (such as Show Message). If you do, you will disconnect the call. Use  instead.

Volume Bar



The Volume Bar controls the volume of the receiver, telephone ring, Handsfree speaker, headset and Background Music. Press either end of the volume bar () to adjust the volume.

Headset

A headset lets you keep both hands free while you are on a call without others overhearing your telephone conversations.

If you plug a headset into your telephone while you are on a call, your telephone's microphone and speaker (or your receiver if you are on a regular call) are turned off and your headset microphone and earpiece are turned on.

You must have the Handsfree/Mute feature assigned to your telephone if you wish to use a headset.

While you are using the headset, the receiver and the switch in the telephone cradle do not work.

A headset cannot be used on an M7100 Telephone.

Using a headset

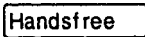
While on a call using the headset, press  to turn your headset on and off.

To answer a call, press .

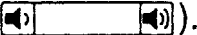
To adjust the volume, press the appropriate side of the volume bar ()

To change to a Handsfree call while you are on a call using your headset, unplug your headset. Your telephone's microphone and speaker turn on and the call becomes a Handsfree call. (It is a good idea to put the call on hold while you do this.)

You may see this prompt when you try to use a headset.

Need Handsfree

You are attempting to use a headset, but Handsfree/Mute is not **programmed** for your telephone. If you are not **using** a headset, you have accidentally plugged your telephone receiver into the headset outlet on the bottom of the telephone.

Hearing Aid Compatibility

The receivers on all Norstar telephones are compatible with hearing aids as defined in the FCC rules, Part 68, section 68.316.

Note: Not all hearing aids are optimized for use with a telephone.

Wall Mounting

Most Norstar telephones can be mounted on a wall. Contact the Installer or Service Representative if you wish to have any telephones in your system wall-mounted.

Page

Feature

Make a page announcement

You can make announcements over the Norstar system.

1. Press **9** .
2. Choose a page type.
3. If necessary, choose a zone.
4. Make your announcement.
5. Press .

Page types are :

- through the telephone speakers (Internal Page)
- EI** through an external speaker (External Page)
- both Internal and External (Combined Page)

Paging shortcuts

Instead of entering the Page feature code followed by the page type, you can enter the following shortcut codes.

internal and zone (0 to 6)

External (code 2 has no zones)

Combined and zone (0 to 6)

Related features

Voice Call

You can make an announcement to one person by placing a voice call to their telephone.

Displays

You will see some of these displays while making a Page announcement.

Denied in admin

Your telephone has not been programmed to allow paging.

ALL er zone:

Enter the desired zone number (0-6) or press **ALL** to page to all zones. (0 equals all zones.)

Invalid zone

You have entered a page zone code that is not between 0 and 6.

Page choice:
SETS SPKR BOTH

Select the type of page you want by pressing:

1 or **SETS** — Internal Page
2 or **SPKR** — External Page
Q or **BOTH** — Combined Page

Page timeout

The time allotted for paging has expired.

Paging ALL

The prompt appears while you are paging and shows the page zone you have chosen. Press **[Feature]** or **[Ris]** when you are finished paging.

Paging busy

A page is already being made in the page zone you have requested.

Notes

Page zone 0 equals all zones.

When making an announcement using External Page or Combined Page, the Long Tones feature is automatically activated for the external paging system only. This allows you to control optional equipment with the Long Tones feature.

Each **Norstar** telephone can be assigned access to Paging and is assigned to one of six page zones, or to none, in Administration programming.

Make sure that everyone who needs to make page announcements has a list showing which telephones are in which page zones.

Priority Call

 Feature 6 9

If you get a busy signal when you call someone in your office, you can interrupt them. Use this feature for urgent calls only.

1. Press **[Feature] 6 9**.
2. Wait for a connection, then speak.

A person who receives a Priority Call while on another call has eight seconds to accept or reject the call. If the person does nothing, the Priority Call feature puts the active call on Exclusive Hold and connects your call.

Displays

You will see some of these displays while making a Priority Call.

Call blocked

You tried to place a Priority Call to another **Norstar** telephone. The person you called has blocked your call. Try to call later.

Denied in admin

You have tried to make a Priority Call, but this feature has not been assigned to your telephone.

Make call first

You have attempted to use the Priority Call feature with no ringing or busy tone on the line. Use Priority Call only when you hear ringing or a busy signal.

Please wait

The party you are calling has eight seconds to decide whether to accept or reject you? Priority Call.

Priority denied

The telephone you are calling is already in a Priority Call or is unable to receive Priority Calls.

Notes

You can make a Priority Call only while your telephone display shows one of the following prompts:

Do not disturb PRIORITY LATER

On another call PRIORITY LATER
--

Calling 221 PRIORITY LATER
--

221 busy PRIORITY LATER

If Call Forward is active at the telephone you are trying to reach, your call will be forwarded.

If the telephone receiving the Priority Call is in a conference call, the other two parties are automatically put on hold when the Priority Call is accepted.

The System Coordinator gives a telephone permission to make Priority Calls in Administration programming.

Service Modes

[Feature] 8 7

Switch to a service mode

You can use Service Modes to make your Norstar system behave differently at different times of day. For instance, all incoming external calls can be directed to a security guard's telephone during the night, or calls to one receptionist can be directed to another receptionist during lunch.

1. Press [Feature] 8 7 on a Control telephone. (See Special telephones for information on Control telephones.)
2. Select the service mode you want.

Cancel Service Modes

[Feature] # 8 7

You can return to normal operation or cancel the manual override of an automatic mode. You cannot cancel an automatic mode.

1. Press [Feature] # 8 7.

Displays

You will see some of the following displays when selecting a service mode.

```
Night Service
QUIT  OK  NEXT
```

The name of the current service mode ("Night Service", in this case) is displayed. Press # or NEXT to see other service mode options. Press [Hold] or OK to select the desired mode.

```
Denied in admin
```

You are trying to activate a service mode from a telephone that is not a Control telephone or Direct-dial telephone, or else all service modes are disabled in Administration programming.

Notes

A service mode allows you to change which lines ring at which telephone, to activate or deactivate the auxiliary ringer for certain lines, and to have Direct-dial calls ring at the Extra-dial telephone. Service modes can be programmed to begin automatically at certain times or they can be turned on and off at the Control telephone. The System Coordinator sets up service modes in Administration programming.

Automatic service modes are indicated by an asterisk (*) before the name of the service mode on the display. You can neither manually activate nor cancel automatic service modes, although you can override them with manual modes.

The Control telephone can override automatic service modes at any time by entering the Service Modes feature code ([Feature] **8** **7**), and selecting a different service mode; this override will remain in effect until it is canceled by means of [Feature] **#** **8** **7**. Note that if you selected a service mode with an asterisk (*), the next automatic service mode will come into effect at the programmed time.

Direct-dial calls to a Direct-dial telephone will ring at the Extra-dial telephone (designated in Administration programming) only when the Service Modes feature code ([Feature] **a** **7**) is entered at that Direct-dial telephone. Note that only the Extra-dial telephone will be activated, not the actual service mode (unless that Direct-dial telephone is also a Control telephone).

Norstar provides three service modes named “Night”, “Lunch”, and “Evening”. You can change these names to suit yourself. In addition, there is normal service when no service modes are active.

Special Telephones

You can assign several special functions to the telephones in your Norstar system. Except where noted, you do not need special hardware. A special function is assigned to a telephone either by your Installer in Configuration programming or by the System Coordinator in Administration programming.

Alarm telephone

An Alarm telephone is a **Norstar** telephone with a two-line display (M7310 or M7324 Telephones) that your Installer has assigned to display Norstar's system alarm codes, should they occur.

If an alarm message appears on the Alarm telephone's display, follow these instructions:

1. Record the alarm number.
2. Press TIME and record the time displayed.
3. Call your Installer or Service Representative and report the alarm code.
4. After speaking to your Installer or Service Representative, press CLEAR.

This is an example of an alarm display.

Al arm: 61-4-2
TIME CLEAR

Report this alarm and the time it occurred to your Installer or service representative.

Central Answering Position

A Central Answering Position (CAP) is a **Norstar M7324** Telephone that **your Installer** has defined as a CAP in Configuration programming. You can connect one or two **Norstar**

The CAP module displays the busy/not busy status of the telephones in your system by using the triangular indicators beside internal Autodial, Programmed Feature or line buttons. A CAP-can support 120 external lines.

You can send up to 30 messages from a CAP.

For more information, see the *Norstar Central Answering Position User Card*.

Control telephone

The Control telephone lets you place the external lines for which it has responsibility into and out of Service Modes. See Service Modes.

Direct-dial telephone

You can dial a Direct-dial telephone with a single digit. The Direct-dial telephone is usually in a central location, such as a receptionist's or secretary's desk. It is usually a Prime telephone and a Central Answering Position (CAP).

There may be up to five Direct-dial telephones in your system, but each telephone in the system is assigned to a single Direct-dial telephone. There is a single Direct-dial digit for the whole system that lets each telephone call its assigned Direct-dial telephone.

Each **Norstar** Direct-dial telephone can send up to 30 messages and each can invoke Service Modes to activate the Extra-dial telephone.

Your Installer sets up Direct-dial telephones in Configuration programming. The System Coordinator assigns telephones to Direct-dial telephones in Administration programming.

Emergency telephone

The Emergency telephone is a single-line telephone (not a Norstar telephone) that functions independently of the Norstar system. You can use the Emergency telephone when your Norstar system is not working.

Emergency Transfer/Power Failure Cut-through provides basic telephone service on external line 001 through an Emergency telephone if the power fails or if a system error occurs.

The Emergency telephone is usually located near the Key Service Unit (KSU). Each KSU can support two Emergency telephones, and each Trunk Module can support one additional Emergency telephone.

Extra-dial telephone

In Service Modes, a second telephone can be assigned to ring on calls made to a Direct-dial telephone. There may be one Extra-dial telephone for each Direct-dial telephone, and it may be a different telephone in each Service Mode.

Hotline telephone

You can call a programmed internal or external telephone number simply by picking up the receiver of the Hotline telephone (or by pressing).

A Hotline telephone can be set up to dial an operator or an emergency number. You should put a notice by the Hotline telephone to let people know which number will be dialed when they lift the receiver.

If the Hotline telephone is set up to dial an external number using the Prime line, there must be an external Prime line assigned to the telephone. If not, the Hotline call will fail.

The System Coordinator sets up the Hotline telephone, the telephone number it dials, and the line on which that number is dialed, in Administration programming.

To bypass a Hotline

Press a line button, or use the Pre-Dial or Automatic Dial feature before you pick up the receiver or press **Handsfree**.

The following displays may occur at a Hotline telephone.

Line in use

The line assigned to the Hotline is in use. Make the call using normal methods or wait until the Hotline line is free.

No line selected

The Hotline has been set up to dial an external number on a Prime line but the Hotline telephone does not have a Prime line. This must be corrected in Configuration or Administration programming.

No free lines

The Hotline has been set up to dial an external number on a Prime line but the Hotline telephone has an internal Prime line and no access to line pools. This must be corrected in Configuration or Administration programming. This message may also appear if the line pool assigned to the telephone is busy.

Prime telephone

Each line in a **Norstar** system can **have** a telephone assigned to it as a Prime telephone. Calls not answered at their normal destinations are transferred to the Prime telephone. The Prime telephone is usually the telephone on the receptionist's desk and it is often the Control telephone and a Central Answering Position as well. A Prime telephone is assigned to a line in Configuration programming.

See the Answering the telephone section for the displays that may occur at a Prime telephone.

Speed Dial

Feature 0

Make a Speed Dial call

You can quickly dial external telephone numbers that have been programmed onto Speed Dial codes.

1. Press **Q** .
2. Enter the appropriate two-digit Speed Dial code.

Norstar supports two types of Speed Dial codes, Personal and System. System Speed Dial codes are from 01 to 70. The System Administrator can assign numbers to System Speed Dial codes for the entire system in Administration programming. Personal Speed Dial codes are from 71 to 94 and may have different numbers assigned to them on each telephone. Users can program their own Personal Speed Dial numbers.

Program Personal Speed Dial

Feature * 4

You can add or change a Personal Speed Dial number on your telephone.

1. Press * 4 .
2. Enter the code that you want to associate with a telephone number.
3. If you want to include a line selection for this number, select the line or line pool. For the M7100 Telephone, you can select a line only.
4. Enter the number you want to program.
5. Press **OK** or **[Hold]**.

Displays

You will see some of these prompts while using or programming Speed Dial.

```
9_
QUIT  BKSP  OK
```

Continue entering the number you wish to program. You can change the number by pressing the left side of the volume bar or by pressing **BKSP**.

When you are finished, press

or **OK**.

```
Access denied
```

You have tried to program a Personal Speed Dial number while someone else on the system is in Configuration or Administration programming.

```
Autodial full
```

You have tried to enter a new Personal Speed Dial Number, but the memory for these numbers in your **Norstar** system is full.

```
Enter code:
```

Enter a two-digit code between 71 and 94 for the personal speed dial number you want to program.

```
Enter digits
QUIT          OK
```

Enter the telephone number you wish to program exactly as you would if you were dialing it normally. When you are finished, press or **OK**.

```
Invalid code
```

You have entered a code outside the code range (01-94).

```
Line in use
```

The line associated with the speed dial number you are trying to use is busy.

```
No number stored
```

There is no number stored on the Speed Dial code you have dialed.

Program and HOLD

If you want to program a line or line pool selection for this Speed Dial, select the line or line pool. Otherwise, enter the telephone number you wish to program exactly as you would if you were dialing it normally. When you are finished, press **Hold**.

Program and OK
QUIT **OK**

If you want to program a line or line pool selection for this Speed Dial, select the line or line pool. Otherwise, enter the telephone number you wish to program exactly as you would if you were dialing it normally. When you are finished, press **Hold** or **OK**.

/Select a 1 line

There is no line associated with the speed dial number you are trying to use. Select a free external line or line pool and enter the Speed Dial feature code again.

Speed dial>

Enter a two-digit Speed Dial code (01-94). You must enter the zero for codes 01 to 09.

Notes

There is no difference between using Personal Speed Dial and using System Speed Dial. They differ only in how you program them.

Speed Dial numbers may include line choices and Host System Signaling codes.

Speed Dial numbers are subject to the same Class of Service as regularly dialed numbers. System Speed Dial numbers can be programmed to bypass dialing restrictions.

Normally, Speed Dial numbers are shown on the display while they are being dialed. System Speed Dial numbers may be programmed to show a Speed Dial name instead of the number, keeping the actual number confidential.

System features

The following features are available for the entire Norstar system.

Accidental Disconnect Protection

If you accidentally drop the receiver back into the telephone cradle while answering a call, you can quickly retrieve the call.

1. Pick up the receiver again or press **Handfree**. You are connected to your call.

Automatic telephone relocation

If Automatic telephone relocation is enabled, you can move your telephone from one Norstar jack to another without it losing any of its custom programming. Your Installer enables Automatic telephone relocation in Configuration programming.

Background Music

Feature **8** **6**

You can listen to music through your telephone speaker.

1. Press **Feature** **8** **6**.

WARNING

In accordance with U.S. copyright law, a license may be required from the American Society of Composers, Authors and Publishers or a similar organization if radio or TV broadcasts are transmitted through the Background Music feature of this telecommunication system.

Northern Telecom Inc. hereby disclaims any liability arising out of the failure to obtain such a license.

The music stops automatically if you make or answer a call.

Your Installer makes this feature available to all telephones in Configuration programming. You will need to supply a music source, such as a radio, attached to your KSU.

Cancel Background Music

Feature # 8 6

You can cancel Background Music.

1. Press Feature # 8 6 .

Class of Service

The Class of Service for a call consists of all the **Norstar** features and lines available to you for that call. This is determined by the features assigned to the telephone in Administration programming, including all Dialing Filters and Remote Access Packages.

Users who need to dial numbers not permitted by the Class of Service of the line or telephone that they are using, can switch to a different Class of Service by entering a Class of Service Password. Remote users can change the set of **Norstar** features available to them by entering the **DISA** DN followed by a Class of Service password.

Internal numbers

Each telephone in the **Norstar** system has its own internal number. The length of internal numbers in your system may be from 2 to 7 digits for a non-expanded system or 3 to 7 digits for an expanded system. All numbers in your system are the same length. Your Installer sets the length of internal numbers (also called the DN length) in Configuration programming.

To find out your internal number, use the Button Inquiry feature (Feature * 0) on an internal line button. On the M7100 Telephone, Button inquiry shows your internal number followed by the function assigned to your single memory button.

Lines

The following features and characteristics are associated with the use of lines.

Disconnect Supervision

When Disconnect Supervision is assigned to a line, the Norstar system monitors it to detect if an external caller hangs up. This allows the system to release the line for other uses. Your Installer assigns disconnect supervision to lines in Configuration programming. Disconnect supervision can be turned on and off only on Loop start trunks. E&M and DID trunks are always disconnect supervised.

Line appearance

Any of the lines in your system may appear at any of your telephones. Your Installer assigns lines to telephones in Configuration programming.

Usually, only the lines that are appropriate for a particular person appear at that person's telephone. When a line is assigned to a telephone it is automatically given a line button on that telephone, if a button is available. The M7100 Telephone has no line buttons for its lines.

Normally, you cannot answer a call that is ringing on a line that does not appear on your telephone. To pick up such a call, use Call Pickup, Call Park, or Transfer.

Hung lines

A line that has been redirected using Line Redirection may remain busy after a call is over. If this happens, the outgoing line for the redirection will also remain busy. These are hung lines and you must clear them.

A line indicator that has been solid for a long time is the only real indication that a line is hung. However, the solid line indicator may also indicate a genuine call in progress. Make reasonably sure that the line is indeed hung before clearing it or you may cut off a real conversation.

You can clear a hung line only at the telephone that was used to redirect the line.

1. Press **Feature** ***** **0** at the telephone that was used to redirect the line.
2. Press the button of the redirected line.
3. Press **SHOW** or **#**.
4. Press **DROP** or **Q**. The hung line is cleared.

Clearing the redirected line clears the outgoing line for the redirection as well.

Line Pools

A line pool allows each telephone access to external lines from a group (or “pool”) of external lines. You can access such lines by pressing an Intercom button and entering a line pool access code or by pressing a memory button programmed with the line pool feature code.

Private lines

A Private line is exclusive to a particular telephone. Calls that are put on hold or left unanswered on a Private line cannot be picked up at any telephone except the Prime telephone.

Prime line

Your telephone can be programmed to select an internal or external line or a line pool automatically whenever you lift the receiver or press **Handsfree**. This is your Prime line.

Ringling Line Preference

Each telephone in the **Norstar** system can be programmed to ring or remain silent for incoming calls on any external lines that appear on the telephone.

For example, a telephone may have buttons assigned for lines 1 to 3, but have only lines 1 and 2 programmed to ring. An incoming call on any of the three lines causes a line button indicator to flash, and the telephone can be used to answer the call. This is especially useful for people who monitor other telephone lines, but want only their own lines to actually ring.

If a telephone has an external line as a Prime line, that line is usually made to ring.

Target line

A target line is used to route a call dialed with a particular number to a particular telephone or group of telephones. A target line can be used for incoming calls only. A single trunk may provide connections to several different target lines. This allows each person or department in the office to have their own number without having as many trunks on the system as there are people in the office.

Overflow Call Routing

If a call comes in for a target line that is busy, **Norstar** routes the call to the Prime telephone for that target line. If there is no Prime telephone assigned to the target line or if a call cannot be directed to a target line, the call will go to the Prime telephone for the incoming trunk.

System Speed Dial

Speed Dial codes 01 to 70 are the same for the entire system. See the Speed Dial section for details.

Time features

The Time features let you check the present time and how long you have spent on a call.

Call Duration Timer

Feature 7 7

You can see how long you spent on your last call or how long you have been on your present call.

1. Press Feature 7 7.
2. Read the display.

Show Time

Feature 8 0 3

You can see the present date and time while you are on a call.

1. Press Feature 8 0 3.
2. Read the display.

Displays

One of the following displays will occur when you use a Time feature.

Make call first

You have not made a call since your telephone's clock was last reset.

221 02:47

The display shows the last call you made, or the current call, and the total elapsed time in minutes and seconds.

Apr 9 9: 54 am

The display shows the present time.

Transfer

Feature

Transfer a call

You can transfer a call to a telephone in your **Norstar** system, within the **Norstar** network, or external to **Norstar**:

1. Make a call, answer a call or take a call off hold.
2. Press (or [Transfer] if programmed).
3. To transfer within the **Norstar** system: dial an internal telephone number or press an Internal **Autodial** button.

To transfer within the network or external to **Norstar**: press a line button and dial the number to which you want to transfer the call, or press an External **Autodial** button.

4. Announce the call after the called party answers. If you do not want to announce the call, complete the transfer as follows.
5. Press or **JOIN** or a programmed Call Queuing button if you wish to answer another call.
6. The call is immediately transferred.

Note: When transferring an external call to an external number, note the following restrictions: at least one of the external calls must have been an incoming call, and that call must be on a disconnect supervised line.

Unsupervised Conference

You can use the 'Unsupervised Conference' feature to connect yourself and two other people, then drop out of the conference leaving the other two to talk to each other. If both parties are external, certain restrictions apply. See Notes at the end of this section.

1. Establish a Conference call as described in Conference.
2. Press .

If you are unable to establish an unsupervised conference, you can put the conference on hold. See the Conference section.

Transfer using Hold

Transfer using Hold can only be used to transfer an external call to another telephone that has a button for the line that the external call is on.

Call the person you want to transfer the call to and tell them there is a call on hold for them. Do not enter the Transfer feature code. To accept the call, your co-worker presses the line button with the flashing indicator.

An M7100 Telephone can transfer a call using Hold but it cannot receive a call transferred in this way.

Displays

You will see some of the following displays while transferring calls.

221 busy CRNCL RETRY

The person to whom you tried to transfer a call is on another call. Press **RETRY** to enter a new internal number. On the M7100 Telephone, you will automatically be returned to the Transf er to: prompt.

Cal 1 transferred

Transient message to indicate that the transfer was successfully completed.

221 DND CALLBACK

The **person** to whom you tried to transfer an external call has Do Not Disturb active on their telephone. Press **CALLBACK** or the flashing line button to reconnect to the call. On the M7100 Telephone, lift the receiver.

Do not disturb CANCL RETRY JOIN
--

The person to whom you tried to transfer an internal call has Do Not Disturb active on their telephone. Press **CANCL** or the flashing line button to reconnect to the call. On the **M7100** Telephone, enter the transfer cancellation code (**Feature** **#** **7** **0**) to reconnect to the call.

221 hung up
CANCL RETRY

The internal caller you were trying to transfer hung up before the transfer was complete.

Invalid number
CANCL RETRY

An invalid DN has been entered, or the transfer feature has been invoked before the complete DN has been entered.

221 no reply
CALLBACK

The person to whom you tried to transfer a call did not answer. Press **CALLBACK** or the flashing line button to reconnect to the call. On the M7100 Telephone, lift the receiver.

221>222
CANCL RETRY JOIN

Press **RETRY** if, after talking to the person at extension 221, you decide to transfer the call to someone else. Press **Als** or **JOIN** to transfer the call from telephone 221 to 222.

Line001 hung up

The external caller you were trying to transfer has hung up before the transfer was complete.

Line001>221
CANCL RETRY JOIN

Press **JOIN** to transfer the call on line 001 to, telephone 221. Press **RETRY** if, after talking to the person at extension 221, you decide to transfer the call to someone else.

Make call first

You have tried to use the Transfer feature when you have no call to transfer.

Not in service
CANCL RETRY

The telephone to which you are trying to transfer a call is out of service.

Restricted call
CANCL RETRY

You cannot transfer the call because of telephone or line restrictions.

Still in transfer
CANCL RETRY

Once you have invoked the transfer feature you must complete the transfer actions before you can access a new feature, answer another alerting call or select an outgoing line.

Transfer denied

CANCL RETRY

Your transfer cannot be completed for the following reasons:

- | All the internal resources needed to perform a transfer are in use. Try again later.
- | You have tried to transfer an external call to another external party. Some restrictions apply. See Notes at the end of this section.
- | An Unsupervised Conference is not possible for your call. See Notes at the end of this section.

Transfer to:

CANCL RETRY

Press **RETRY** if you entered the wrong internal number or if the person you are transferring the call to is unavailable.

Notes

If an external call is transferred to a busy telephone, or not answered after a few rings, the call automatically rings you back and the display indicates that the telephone was busy or that no one answered.

You can establish an Unsupervised Conference whether the other two people are inside or outside the **Norstar** system. However, if both of the other people are outside the system there are some restrictions: at least one of the outside callers must have called you and that call must be on a disconnect supervised line.

When transferring an external call to an external number, note the following restrictions: at least one of the external calls must have been an incoming call, and that call must be on a disconnect supervised line.

In certain situations, you may experience lower volume levels when using external Transfer and unsupervised Conference with two external calls.

Using **Norstar** remotely

You can use the lines, and some of the features, of a **Norstar** system from outside that system. You can do this over the public telephone network when you are away from the office, or you can call into a **Norstar** system in another office from your own **Norstar** system over a private network.

The exact facilities available to you through Remote Access will vary depending on how your system is set up. The **Norstar** features that can be made available to remote users are: access to lines, access to line pools, and remote paging.

Examples

A salesman who spends most of his time on the road needs to make long distance calls to the European office. Your **Norstar** system has a leased line to Europe with reduced transatlantic charges. You provide that salesman with a Class of Service password that gives access to the transatlantic line. The salesman can then telephone into the **Norstar** system-from a client's site, enter his Class of Service password, and use the leased transatlantic line to make his calls.

The manager of one of your branch offices also needs to talk to the European office. She uses a private network line between her branch office and the head office to access the head office's **Norstar** system and use its transatlantic lines.

Accessing **Norstar** remotely

Over the public network

You can use **Norstar** remotely over the public telephone network.

1. Dial the **Norstar** system's remote access number.
2. If you hear a stuttered dial tone, enter a COS password.
3. Wait for the system dial tone.

Over a private network

You can access Norstar remotely using a private network line.

1. Select the private network line or the line pool that contains private network lines.
2. Dial the number, if any, needed to access the remote system.
3. If you hear a stuttered dial tone, enter a COS password.
4. Wait for system dial tone.

Using Norstar remotely

Once connected to a remote system you can do any one of the following:

- enter the DISA DN followed by a COS password to change your Class of Service.
- dial the number of someone on the remote Norstar system.
- dial a line pool access code and make an external call.
- enter a Page feature code (60 through 63). Use instead of when entering the feature codes. See Page.

Tones you may hear

Busy tone	The number you dialed on the Norstar system is busy. Your call will be disconnected after five seconds.
Norstar system dial tone	You may: <ul style="list-style-type: none"> enter the DISA DN followed by a COS password to change your Class of Service. dial the number of someone on the remote Norstar system. dial a line pool access code and make an external call. enter a Page feature code (60 through 63) using <input type="checkbox"/>* instead of <input type="checkbox"/>Feature . See Page.
Fast busy tone	You have done one of the following: <ul style="list-style-type: none"> entered an incorrect COS password. Your call will be disconnected after five seconds. taken too long while entering a COS password. Your call will be disconnected after five seconds. tried to use a line pool or feature not permitted by your Class of Service. You will hear system dial tone again after five seconds. dialed a number in the Norstar system which does not exist. Your call will be disconnected after five seconds.
Stuttered dial tone	Enter your COS password on the dial pad of your telephone.

Controlling access to your **Norstar** system

It is important that you maintain the security of your **Norstar** system by limiting access to authorized users and limiting those users to just those features they need. Remember that a remote user can make long distance calls that will be charged to your company and can make page announcements in your office.

Direct Inward System Access

You can control access to your **Norstar** system with Direct Inward System Access (DISA). If you set up the trunk used for remote access for auto-answer with DISA, callers will hear a stuttered dial tone and must enter a Class of Service password before they are allowed into the system. Access to your **Norstar** system from the public telephone network should always be controlled with DISA.

If you are setting up access to your system from another **Norstar** system over a private network, you may not need DISA. If you set up your E&M trunk to answer without DISA, callers from remote **Norstar** systems will receive system dial tone immediately.

Your **DISA** facility has a number (the **DISA DN**) which an external caller can dial when they hear system dial tone to activate **DISA** and enter a Class of Service password to change to a different Class of Service.

Class of Service

You can control which feature a remote user can access through the Class of Service for the call. The Class of Service of a Remote Access call is determined either by the Class of Service password entered when the system answers with **DISA** or by the Class of Service associated with the trunk when the system answers without DISA.

After having accessed the system, a remote user can change the Class of Service for the call by dialing the **DISA DN** followed by a Class of Service password.

Maintaining security

To maintain the security of your system, the following practices are recommended:

- Warn anyone to whom you give the remote access number to keep it confidential.
- Change Class of Service passwords often.
- Warn anyone to whom you give a Class of Service password to remember it and not to write it down.
- Remove the Class of Service password of anyone who leaves your company.

Notes

To use the system remotely, the telephone you are using to call the system must use tone dialing.

Remote Access is possible only on DID and E&M trunks, and Loop start trunks that are set to auto-answer.

If the Loop start trunk used for Remote Access is set to **unsupervised** mode, auto-answer will not function and the caller will hear ringing instead of a stuttered or the system dial tone.

If you use one **Norstar** system to call remotely into another **Norstar** system, you can use the available features of the remote **Norstar** system by pressing ***** followed by the feature code. If you press , you will invoke the features of the local system, not the remote one.

Your Installer sets **trunks** to be **auto-answer**, with or without DISA, in Configuration programming. **DNs** are set in Configuration programming. The System Coordinator sets up Classes of Service and Class of Service passwords in Administration programming.

In certain situations, you may experience lower volume levels when using **DISA** or using **Norstar** remotely.

Voice Call

Feature 6 6

Make a voice call

You can make an announcement or **begin** a conversation through the speaker of another telephone in the system.

1. Press Feature 6 6 .

Mute Voice Call tones

When a Voice Call begins at your telephone, you hear a beep every 15 seconds as a reminder that the microphone is on. You can stop it beeping.

1. Pick up the receiver or press Handsfree .

Handsfree Answerback

If Handsfree Answerback is assigned to your telephone, you can respond to a Voice Call without touching the telephone.

1. When someone makes a Voice Call to you, simply start talking. Your telephone's microphone picks up your voice.

Your telephone will beep periodically to remind you the microphone is on. You can stop it beeping.

1. Pick up the receiver or press Handsfree .

Voice Call Deny

Feature 8 8

You can prevent your telephone from receiving Voice Calls.

1. Press Feature 8 8 . Voice Calls will ring like regular internal calls. Your other calls will proceed normally.

Cancel Voice Call Deny

Feature # 8 8

You can cancel Voice Call Deny.

1. Press Feature # 8 8 .

Displays

You will see some of these displays while making a Voice Call.

Dial voice call

Dial the internal number or press the internal **Autodial** button of the person to whom you want to speak.

Voice call

The line is open for you to speak.

No voice call

The telephone receiving the call cannot accept Voice Calls for one of the following reasons: it is active or ringing with another call; it is in Call Forward mode; it is in Do Not Disturb mode; it has Voice Call Deny turned on; it is not a **Norstar** telephone.

Your call proceeds automatically as a regular ringing call.

Notes

Once you have answered a Voice Call, you can put it on hold, transfer it, or otherwise treat it as a normal call.

When you have Handsfree Answerback assigned to your telephone, and you are using an on-hook Dialing Mode, the microphone and speaker are both activated for external calls.

The System Coordinator assigns Handsfree Answerback to a telephone in Administration programming. You can not assign Handsfree Answerback capability to the **M7100** Telephone.

Using Norstar features

Using a Norstar feature

1. Press **Feature** , and enter the desired feature code on the dial pad.
OR
Press the programmed memory button.
2. Follow the display messages.

Note: On M7310 and M7324 Telephones, some features are also available on the display buttons.

Programming a Norstar feature on a memory button

1. From an idle telephone, or with your calls on hold, press **Feature** * **3** .
2. Press the memory button that you want to program. (This step is not required on the M7100 Telephone.) See your telephone user card for the location of the memory buttons.
3. Enter the **feature** code you want to program.

Personalizing your telephone

Autobumping	Allows the last log entry to be deleted from a full Call Log when a new item is logged, so that the new log entry can be stored. For more information, see Call Log. Cancel Feature # 8 1 5
Background Music	Allows you to listen to music (provided by your office) through your telephone speaker when you are not on a call. Cancel Feature # 8 6
Button Inquiry	Checks what is programmed on any button. Use this feature when labeling memory buttons.
Call Log Password	Program a password for your Call Log. To remove the password, see your System Coordinator.
Class of Service	Overrides the Class of Service on a telephone to allow you to make a call from that telephone. The Class of Service determines which numbers you can dial. Switch from one Class of Service to another using this feature code and a password provided by your System Coordinator.
Contrast Adjustment	Adjusts the contrast of your telephone display. Press 1 through 9 (depending on your telephone).
Dialing Modes	Changes the on-hook Dialing Modes. The three Dialing Modes are: ‘Automatic Dial: If you have a Prime line, dial a telephone number without pressing a line button. A line is selected automatically. Pre-Dial: Dial a telephone number. Edit it by pressing BACKSP , or the left side of ← . Press a line button to place the call . Standard Dial: Press a line button, then dial a telephone number.
Do Not Disturb	Prevents incoming calls from ringing at your telephone. Cancel Feature # 8 5
Language Choice	Selects English language for the telephone display. Selects Spanish language for the telephone display.

Remote system signaling

Link	Feature <input type="text" value="7"/> <input type="text" value="1"/>	Generates a Link signal (also called flash or recall) on an active line to access other systems or carriers.
Long Tones	Feature <input type="text" value="8"/> <input type="text" value="0"/> <input type="text" value="8"/>	Permits communication with devices (such as fax or answering machines) on an active line that use longer tone signals. The tone lasts as long as a dial pad button is held down, and only for the current call.
Pause	Feature <input type="text" value="7"/> <input type="text" value="8"/> <input type="text" value="*"/>	When programmed in an External Autodial sequence, inserts a 1.5-second delay in a number being dialed. For Pulse and Tone Dialing For Pulse Dialing only
Programmed Release	Feature <input type="text" value="7"/> <input type="text" value="0"/> <input type="text" value="8"/> <input type="text" value="8"/>	When programmed at the end of an External Autodial sequence, performs the same function as FRS .
Timed Release	Feature <input type="text" value="7"/> <input type="text" value="2"/>	Generates a longer Link signal (1.5 seconds) on an active line. Use this feature when you want to release a call on your line but retain the use of the line for another call.

Using Norstar from outside the office

Calling **Norstar** from outside the office

You can use your **Norstar** system even when you are not in the office to make calls or use the paging feature. You may be required to enter a Class of Service password to get onto the system. Your Class of Service determines which features you can **use and** which numbers you can dial.

Note: Ask your System Coordinator for details on your Classes of Service and Class of Service passwords.

*Connecting to the **Norstar** system:*

1. Dial the remote access number provided by your System Coordinator.
2. If you hear a stuttered dial tone, enter a 6 digit COS password.
3. When you hear a steady dial tone, you are connected to the **Norstar** system. You can do one of the following:
 - Change your Class of Service by dialing the **DISA DN** and entering a Class of Service password.
 - Dial the number of someone in the office.
 - Enter a line pool access code to use external lines in a line pool.
 - Enter a Page feature code (***** through *****) and the appropriate zone number to page someone in the office. See the Page feature on this card for more information on the Page feature.

System features

Call Duration Timer	Feature <input type="text" value="7"/> <input type="text" value="7"/>	Briefly displays the length of your current call. If your telephone is idle, the length of your most recent call is displayed.
Call Log	Feature <input type="text" value="6"/> <input type="text" value="1"/> <input type="text" value="2"/>	<p>Log to view stored caller information. The Call Log displays use special characters.</p> <ul style="list-style-type: none"> <u>1</u> A new item in the Call Log is underlined. 3 Answered calls are identified. 5 Long distance calls are identified. ✓ The disolaved information has been truncated. <p>Note: Names and numbers for external callers are displayed only if you have subscribed to Call Display services from your local telephone company.</p> <p><i>Calling from your Calf Log:</i></p> <ol style="list-style-type: none"> 1. Navigate to the appropriate log item, and display the number. 2. Edit the number, if required. The leading digits may need to be trimmed, or digits may need to be added for Long Distance or line pool access. See your System Coordinator. 3. Press a line button. 4. Lift the receiver.
Message	Feature <input type="text" value="6"/> <input type="text" value="5"/>	<p>Reply to Message: Review your list of external and internal display messages, and return calls. Cancel <input type="text" value="6"/> <input type="text" value="5"/></p> <p>Send Message: Leave a message on a co-worker's telephone display to call you back. Cancel <input type="text" value="6"/> <input type="text" value="1"/></p>
Page	Feature <input type="text" value="6"/> <input type="text" value="0"/>	<p>Allows you to make announcements through either the internal or external speakers, or both. Enter the feature code, the page code (1 for internal, 2 for external, or 3 for both), and the zone (0 to 6).</p> <p>Feature <input type="text" value="6"/> <input type="text" value="2"/> External: Allows you to make announcements through your off ice's loudspeaker system (if connected).</p> <p>Feature <input type="text" value="6"/> <input type="text" value="3"/> External/Internal: Allows you to make announcements through both your Norstar telephone speakers and your office's loudspeaker system. Enter the feature code, and the zone (0 to 6).</p> <p>Feature <input type="text" value="6"/> <input type="text" value="1"/> Internal (Zone): Allows you to make announcements, through the Norstar telephone speakers, to a group of Norstar telephones. Enter the feature code, and the zone (0 to 6). 0 pages all zones.</p>
Service Modes	Feature <input type="text" value="8"/> <input type="text" value="9"/>	<p>Activates one of up to three different telephone answering options, eliminating the need to forward all your calls. Only an assigned Control Telephone can turn ON Service Modes. See your System Coordinator.</p> <p>Cancel <input type="text" value="8"/> <input type="text" value="7"/></p>
Show Time	Feature <input type="text" value="8"/> <input type="text" value="0"/> <input type="text" value="3"/>	Briefly displays the date and the time.

Handling calls

Call Forward	Feature <input type="text" value="4"/>	Sends your calls to another telephone in your Norstar system. Cancel <input type="text" value="#"/> <input type="text" value="4"/>
	Feature <input type="text" value="8"/> <input type="text" value="2"/>	Camp-On: Re-routes a call to another telephone even if all its lines are busy.
	Feature <input type="text" value="8"/> <input type="text" value="4"/>	Line Redirection: Redirects one or more lines on your telephone so that calls coming in on the line(s) are directed to one or more locations outside the Norstar system. Cancel <input type="text" value="Feature"/> <input type="text" value="#"/> <input type="text" value="8"/> <input type="text" value="4"/>
Call Information	Feature <input type="text" value="8"/> <input type="text" value="1"/> <input type="text" value="1"/>	displays the name, number and line name of a ringing or held call. Press <input type="text" value="#"/> or VIEW repeatedly to cycle through the three displays of information.
Note: Names and numbers for external callers are displayed only if you have subscribed to Call Display services from your local telephone company.		
Call Park	Feature <input type="text" value="4"/> <input type="text" value="7"/>	Automatically puts a call on hold so that it can be retrieved from any telephone in your Norstar system. The display-shows a retrieval code.
	Feature <input type="text" value="9"/> <input type="text" value="0"/> <input type="text" value="9"/>	Retrieval: Answers a parked call from any telephone in your Norstar system by pressing <input type="text" value="Intercom"/> and dialing the retrieval code. On the M7100 Telephone, dial just the retrieval code. The retrieval code is made up of a programmable Call Park prefix (0 to 9), followed by a call number (01 to 09).
Conference	Feature <input type="text" value="3"/>	<p><i>Setting up a three-person call:</i></p> <ol style="list-style-type: none"> 1. Make or answer the first call. 2. Put the first call on hold. 3. Make or answer the second call. 4. Press <input type="text" value="Feature"/> <input type="text" value="3"/> (or press <input type="text" value="Cont/Trans"/> if programmed). 5. Press the line button of the first held call. (This step is not required on the M7100 Telephone.)
		<p>Splitting a conference: To speak privately to one of the callers, or to drop one call and stay connected to another, or to hold both parties as separate calls, you must first split the conference.</p> <ol style="list-style-type: none"> 1. Press the line button for one of the calls. The other call is put on hold. To re-establish the conference, press <input type="text" value="Feature"/> <input type="text" value="3"/>.
		<p><i>Removing yourself from the conference temporarily:</i></p> <ol style="list-style-type: none"> 1. Press <input type="text" value="Hold"/>; the other two callers can still speak to each other.
		<p><i>Removing yourself from the conference permanently:</i></p> <ol style="list-style-type: none"> 1. Press <input type="text" value="Feature"/> <input type="text" value="7"/> <input type="text" value="0"/> (or <input type="text" value="Transfer"/> if programmed). The other two parties remain connected.
		<p><i>Note:</i> Some external lines may not support this type of transfer if two external parties are involved.</p>

194 / Modular DR5 Telephone Feature Card

Do Not Disturb	Feature <input type="text" value="8"/> <input type="text" value="5"/>	Blocks an alerting Priority Call on your telephone.
Exclusive Hold	Feature <input type="text" value="7"/> <input type="text" value="9"/> or Feature <input type="text" value="p"/> <input type="text" value="h"/> <input type="text" value="e"/> <input type="text" value="s"/>	Temporarily suspends an external call and prevents other from picking it up. Exclusive Hold Retrieval: Press <input type="text" value="Line"/> of the held call. (Press <input type="text" value="Hold"/> on the M7100 Telephone.)
Group Listening	Allows <input type="text" value="y"/> <input type="text" value="b"/> <input type="text" value="l"/> <input type="text" value="d"/> <input type="text" value="o"/> <input type="text" value="z"/> <input type="text" value="l"/>	Use both the receiver and your speaker at the same time while you are on a call. If you experience feedback, turn the volume down, and before hanging up, press Ris . Cancel Feature <input type="text" value="8"/> <input type="text" value="0"/> <input type="text" value="2"/>
Logit	Store caller <input type="text" value="s"/> <input type="text" value="i"/> <input type="text" value="n"/> <input type="text" value="f"/> <input type="text" value="o"/> <input type="text" value="r"/> <input type="text" value="m"/> <input type="text" value="a"/> <input type="text" value="t"/> <input type="text" value="i"/> <input type="text" value="o"/> <input type="text" value="n"/> <input type="text" value="i"/> <input type="text" value="n"/> <input type="text" value="g"/> <input type="text" value="l"/> <input type="text" value="o"/> <input type="text" value="g"/> <input type="text" value="."/> Note: Names and numbers for external callers are displayed only if you have subscribed to Call Display services from your local telephone company.	
Privacy	Feature <input type="text" value="8"/> <input type="text" value="3"/>	When Privacy is ON, other Norstar users with the same line are prevented from joining your current external call. If Privacy is OFF, other Norstar users with the same line can join in on your external call by pressing that line button. Enter the feature code a second time to restore the original setting.
Transfer	Feature <input type="text" value="7"/> <input type="text" value="0"/>	Sends a call to another telephone in your Norstar system, over a network or outside your Norstar system.

Using **Transfer**

1. Make or answer a call.
2. Press **Feature** (or **Transfer** if programmed).
3. Dial an internal telephone number, or press **an Autodial** button.
4. If you wish, you can announce the call, after the called party answers.
5. Press **Ris** or **JOIN**.
The call is immediately transferred.

Transfer within **your Norstar** network or external to **Norstar**

1. Make or answer a call.
2. Press **Feature** (or **Transfer** if programmed).
3. Select a line and dial the telephone number that you wish to transfer the call to.
4. If you wish, you can announce the call after the called party answers.
5. Press **Ris** or **JOIN**.
The call is immediately transferred.

You can also do an external transfer using Unsupervised Conference:

1. Make or answer a call.
2. Call the person to whom you wish to transfer the call.
3. Establish a conference with the two parties.
4. Drop out of the conference using the Unsupervised Conference feature.

Note: If an external call is transferred to a busy internal line, or not answered after a few rings, the call automatically rings you back and the display indicates that the line was busy or that no one answered.

Answering and making calls

Call Pickup.	Feature <input type="text" value="7"/> <input type="text" value="6"/>	Directed Pickup: Answers a selected telephone in your system.
	Feature <input type="text" value="7"/> <input type="text" value="5"/>	Group Pickup: Answers a call that is ringing at another telephone in the same pickup group. The external call that has been ringing longest is answered first.
	Feature <input type="text" value="7"/> <input type="text" value="0"/>	Answers an external call that is ringing on a line that has been placed into Service Modes from any telephone in the Norstar system. This feature does not work on private lines.
Call Queuing	Feature <input type="text" value="6"/> <input type="text" value="0"/> <input type="text" value="1"/>	when several calls arrive at the same time. The external call that has been ringing longest is answered first.
Last Number Redial	Feature <input type="text" value="5"/>	Automatically redials the last external telephone number that you dialed. This feature is available on the <u>[Last]</u> memory button on most telephones.
Line Pools	Feature <input type="text" value="6"/> <input type="text" value="4"/>	Telephones can share several external lines for making outgoing calls without requiring each telephone to have a button for every line.
<p><i>Using a Line Pool:</i></p> <ol style="list-style-type: none"> 1. Press <input type="text" value="Intercom"/> and dial the Line Pool access code for one of the Line Pools assigned to your telephone, or press <input type="text" value="Line pool"/> (if programmed). 2. If you are using a line pool which connects you to the public network, dial the telephone number of the person you want to call. <p>If you are using a line pool that automatically connects you to another Norstar system, see Using Norstar from outside the office.</p> <p>If you are using a line pool which automatically connects you to a system other than Norstar, follow the procedure for using that system. Ask your System Coordinator if you need help.</p> <p>Note: See your System Coordinator for your Line Pool access code.</p>		
Priority Call	Feature <input type="text" value="6"/> <input type="text" value="9"/>	Interrupts a call at another telephone, or overrides Do Not Disturb at a telephone. See your System Coordinator.
Ring Again	Feature <input type="text" value="2"/>	When another telephone or Line Pool within the Norstar system is busy, Ring Again signals you to call back when the telephone or Line Pool becomes available. Cancel <input type="text" value="Feature"/> <input type="text" value="#"/> <input type="text" value="2"/>
Saved Number Redial	Feature <input type="text" value="6"/> <input type="text" value="7"/>	When you are active on a call, this feature stores the external telephone number of a call you have dialed. When you are not active on a call, this feature redials the number previously stored.
Speed Dial	Feature <input type="text" value="0"/>	Dials the number stored for a Speed Dial code. After entering the feature code, enter the two-digit Speed Dial code (01 to 94) for the number YOU want.
Voice Call	Feature <input type="text" value="6"/> <input type="text" value="6"/>	Begin a conversation through the speaker of another telephone without first making the other telephone ring. To answer a Voice Call, pick up the receiver, or press <input type="text" value="Handsfree"/> .

The Norstar Prime Telephone

What is a Prime Telephone?

A Prime Telephone can be any Meridian **Norstar*** telephone that has been assigned to provide a backup answering service for incoming external calls. An external call rings at a Prime Telephone when the call is not answered at any other telephones with that call's line appearance.

A Prime Telephone can be any one of the following:

- any **Norstar** telephone
- an M7310 telephone with a Busy Lamp Field (BLF)
- an M7324 telephone with Central Answering Position (CAP) module.

Your role in operating a Prime Telephone

As the assigned Prime Telephone operator, you are responsible for answering unanswered external calls. You are alerted to these calls when your telephone display shows you a descriptive message, the line indicator ► flashes, and the call rings.

After answering a call, you may take a message or redirect the call to another telephone.

Who assigns the external lines for my Prime Telephone?

Check with your System Coordinator to determine which external lines have been assigned for backup answering and which of those lines ring at your Prime Telephone. To help you do your job well, this person should provide a list of names and numbers associated with each **Norstar** telephone and external line, and a list of System Speed Dial names and numbers. This person can also tell you which features have been assigned to your telephone.

There may be more than one Prime Telephone operator in your **Norstar** system. If this is the case, then each Prime Telephone operator is responsible for a particular group of assigned lines when providing a backup answering service. Let the appropriate people within your backup answering group know that you are now providing a service for them.

* Meridian and **Norstar** are trademarks of Northern Telecom.

Answering calls

When do I answer a call?

You answer a call if:

- someone within **Norstar** calls you. You hear the **Norstar** internal ring (two quick rings followed by a longer pause), and an indicator ► flashes beside one of your telephone's intercom buttons.
- an external call comes directly to your Prime Telephone. You hear the familiar external telephone ring, and an indicator ► flashes beside one of your telephone's external line buttons.
- a call is redirected to your Prime Telephone from somewhere else within the **Norstar** system. You hear an internal ring, an external ring, or the Camp-On tone (two quick beeps), and you see a message on the display of your telephone.

Note: You do not answer the call if your Prime Telephone does not ring.

How do I answer a call?

If you want a line to be automatically selected:

1. Pick up the receiver or press **Handsfree** (if assigned).

O R

If you want to manually answer a line:

1. Press the line or intercom button with a slow flashing indicator ►.
2. Pick up the receiver if you want the handsfree microphone OFF.

Note: A fast flashing indicator ► shows that a line is on hold.

Handling more than one call at once

When you have **more** than one call arriving at your telephone, the Call Queuing feature allows you to answer each of the waiting calls by automatically selecting the next call for you.

Use Call Queuing when you are on a call and a new call alerts you by ringing at your telephone, or by sending Call Queuing tones.

1. Pick up the receiver to answer the first call.
2. Press **Feature** **8** **0** **1** or the Call Queuing button if programmed.
The call you were on is automatically put on hold.
3. To return to a previous call:
Press the external line button of the call on hold.
4. Continue to answer incoming calls.
5. Press **Rls** when you are finished with the call you are on.

Redirecting calls using display messages

The display messages which appear on your Prime Telephone for redirected Norstar calls should help you to understand why those calls were passed to your Prime Telephone. This information is useful when you need to decide what to do with the call once it has been answered.

The following table lists some example display messages that could appear on a Prime Telephone when you receive redirected calls:

Example Prime Telephone display message	What is happening to the call at the other telephone
Held by KAREN	Karen holds a call for too long.
JOHN DND	The call you transferred is returned to you because the telephone is in Do Not Disturb mode.
DRTLine025	Delayed Ring Transfer redirects an unanswered call on line 025.
Line012 to prime	A call on line 012 cannot ring elsewhere.
Line010>>JANET	A call on line 010 was forwarded or routed to Janet, but was not answered.
Line003 call back	A transferred, camped, or parked call on line 003 was returned to the originator using the Callback feature, but was not answered.

The Held Line Reminder message **Held call** is repeated periodically after the first message **Held by KAREN** appears. This message is accompanied by the same tone used with the Camp-On feature (two quick beeps).

Completing a call

Your options

You have just answered a call for someone else. What do you do next?

You can:

Transfer the call to another telephone within your **Norstar** network, or outside the **Norstar** system.

OR

Camp the call on another **Norstar** telephone.

OR

Announce the call to the office, asking that someone take the call.

OR

Take a message.

Transferring the active call

To a telephone **within your Norstar** system:

Check whether the telephone to which you want to transfer is already busy:

- Is there an indicator ► beside the Internal **Autodial** button for the other telephone?
- If you have a BLF, is the indicator ON for the other telephone?
- If you have a CAP module, is the indicator ► ON for the other telephone?

To transfer a call:

1. Make or answer a call.
2. Enter the transfer feature code.
3. Dial an internal telephone number or press an **Autodial** button.
4. If you wish, you can announce the call after the called party answers.
5. Press **[Ris]** or JOIN.
6. The call is immediately transferred.

To a telephone within the **Norstar** network or external to **Norstar**:

Use the above procedure, substituting the following for step 3:

3. Press a line button and dial the number that you wish to transfer the call to.

You can also do an external transfer using Unsupervised Conference:

1. Make or answer a call.
2. Call the person to whom you wish to transfer the call.
3. Establish a conference with the two parties.
4. Drop out of the conference using the Unsupervised Conference feature.

Note: Some external lines may not support an unsupervised conference call. In this case, you may put the conference on hold, allowing the other two parties to continue talking to each other.

Note: Do not use the **[Ris]** button to create an unsupervised conference. Although it will create an unsupervised conference with internal parties, it will not work in a conference with two external **parties**

Completing a call

- Camping the call
- If the **Norstar** telephone you want to transfer the call to is busy on another call, you may want to camp the call on that telephone. The person receiving the camped call will hear Camp-On tones (two quick beeps).
1. Press **Feature** **8** **2** or the Camp-On button (if programmed).
 2. Dial the internal number of the other telephone or **press its Internal Autodial** button if programmed.

Announcing the active call

You are trying to pass calls you have answered to co-workers who are not at their telephones. Using the Page feature, you can announce the calls over the **Norstar** telephones, an external loudspeaker, or both. A co-worker hearing an announcement can answer the call from the nearest **Norstar** telephone.

*If **you** want your co-worker **to** take the **call from** a specific **Norstar** telephone:*

1. Place the call on hold.
2. Using the Page feature, announce the call and the location of the telephone to which you will transfer the call.
3. Transfer the call to the appropriate **Norstar** telephone.
OR
Camp the call on the appropriate **Norstar** telephone.
4. Replace your receiver.

*If **you** want **your co-worker** to take the **call** on a specific line:*

1. Place the call on hold.
2. Use the Page feature to announce the call and its line number.
3. Replace the receiver.

Your co-worker can now go to the nearest **Norstar** telephone that has that line, select the line, and lift the receiver.

*If **you** want **your co-worker** to take the **call from** any **Norstar** telephone:*

1. Use the Call Park feature to place the call on hold. Your telephone shows a three-digit Call Park Retrieval code on the display.
2. Use the Page feature to announce the call and the Call Park Retrieval code.
3. Replace your receiver.

Your co-worker can now retrieve the call from any other **Norstar** telephone by lifting the receiver and dialing the three-digit code.

Note: Remember that callback (the call is redirected back to your Prime Telephone) occurs if your transferred, parked, or camped call goes unanswered.

Useful Norstar features

informing your -
co-workers about
their calls

Use the Send Message feature to notify co-workers that they should call you for information.

If the person you are trying to call is on another line, or their telephone has Do Not Disturb ON, a display message shows you that their telephone is busy. If the person you are trying to call does not answer, a display message informs you that there is no reply. In each case, you can use the Ring Again feature.

The Ring Again feature is a method of ensuring that you immediately know when there is a change in the use of the other telephone. You can then try again to place a call.

Working with other
features

Some of the many **special features** which **Norstar** provides may be particularly useful to you. Some of these features, however, are only available if assigned during Configuration or Administration programming. Speak to your System Coordinator to determine which features you can use, and to obtain details on how to use them.

Answer Group: You can immediately answer and monitor a specific group of **Norstar** telephones, for example, your managers', using Answer buttons.

Automatic Handsfree: If programmed, you can use the Handsfree microphone and speaker for all your calls.

Call Pickup Directed: Anyone in the office can answer a call ringing at any other **Norstar** telephone by dialing that telephone's internal number.

Call Pickup Group: Any member of a specified group can answer an external or internal call ringing at another telephone within that specified group.

Direct-Dial Telephone: If your Prime Telephone is administered as a **Direct-Dial** telephone, anyone assigned to your Direct Dial telephone can quickly contact you by dialing an assigned single-digit number.

Hotline: A **Norstar** telephone may be programmed to automatically dial your Prime Telephone as soon as its receiver has been lifted.

Multiple Prime Telephones: There may be a requirement for more than one Prime Telephone to provide backup answering.

Page Zone: If you do not want to disturb the entire office with an announcement, you can direct the page to a choice of smaller areas.

Priority Call: If you have answered an urgent call for someone who is busy on another line, you can interrupt the person with this feature.

Other information

Some unique situations

If an external call comes to you, and no remaining external line buttons are available, the indicator ► for that call will appear next to any available intercom buttons on your telephone.

If your Prime Telephone receives a callback call, you will hear the internal telephone ring instead of the familiar external telephone ring.

The Held Line Reminder or the Delayed Ring Transfer feature is not available unless assigned during Configuration programming.

If you are using all of your external line buttons and intercom buttons, you can still receive a camped call (you will hear two quick beeps).

If your Prime Telephone is an **M7324 telephone**, you can monitor the busy/not busy status of other **Norstar** telephones. Check for the presence or absence of indicators ► beside the Internal **Autodial** buttons for the other telephones.

Where to get help

To learn more about **Norstar** and its features, the System Coordinator can provide you with the following **Norstar** documents:

*The Meridian **Norstar** Telephone User Cards* show you how to:

- make an external call
- make an internal call
- put a call on hold
- use **Handsfree**
- program memory buttons.

*The Meridian **Norstar** Feature Card* lists the feature codes and describes the features.

*The Meridian **Norstar** Busy Lamp field (BLF) User Card* describes how to use the Busy Lamp Field.

*The Meridian **Norstar** Central Answering Position (CAP) User Card* describes how to use Central Answering Position modules.

Your Norstar M7100 telephone

Release button _____
cancels active calls.

Display _____
shows the time, date, call information and guides you while using Norstar* features.

Memory button _____
is programmable to store a feature or to automatically dial internal or external number.

Dial pad _____

Feature button _____
starts or ends a feature.

Volume control _____

Hold button _____

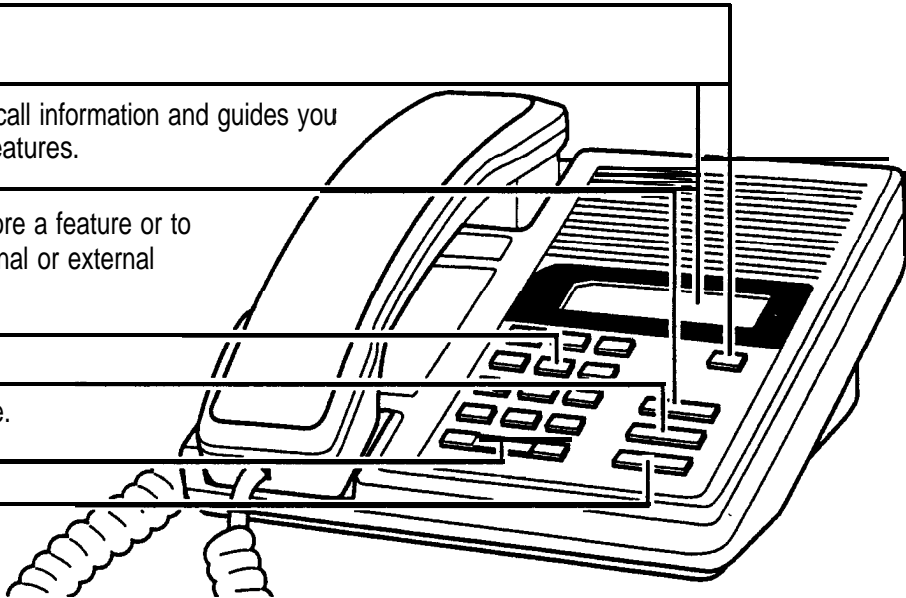

Button inquiry

Confirm that your memory button has the correct snap-on cap by checking its programming.

1. Release all calls and open lines with dial tone.
2. Press **Feature** * **0** .
3. Read the display.
4. Press **Feature** when finished.

Adjusting display contrast

1. Press **Feature** * **7** .
2. Press **1** to **9** for the level you want.

Selecting a ring type and volume

1. Press **Feature** * **6** .
2. Press **1**, **Q**, **a** or **4** to hear the different types of rings.
3. While the telephone is ringing, press  to adjust the volume.
4. Press **Softerre** to store the ring.

Adjusting receiver or telephone speaker volume

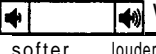
1. Press  when using the receiver or the speaker.

* Meridian and Norstar are trademarks of Northern Telecom.

Making calls

- Internal calls
1. Pick up the receiver.
 2. Dial the internal number.

-
- External calls
1. Pick up the receiver.
 2. Dial **9** (or your system's external line access code).
 3. Dial the external telephone number.

Note: internal numbers and the external access code are supplied by your System Coordinator.

Making and answering a second call

The M7100 telephone allows you to have two calls active at the same time. By using **Hold** you can switch between calls.

To answer a second **call while on another call**

1. Press **Hold** to put the first call on hold.
The second call automatically comes onto the line.

To hold a call and make a second call

1. Press **Hold** to put the first call on hold.
2. Dial the telephone number for the second call.

To return to the first call

1. Press **Hold** again to return to the first call on hold.
The second call is automatically put on hold.

Hold

To hold a call

1. Press **Hold**.
2. Press **Hold** again to return to the call on hold.
Check the display for confirmation or additional information.

Programming the memory button

About the memory button

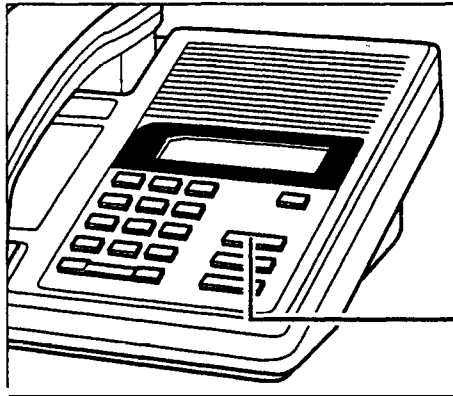

The memory button can store a telephone number or feature code to give you one touch dialing or feature activation. You can change the memory button by programming it with a new number or feature code.

Memory button

Remember: Press * to check the memory button.

Programming memory buttons

External *autodial*

1. If you are on a call or an open line with dial tone, press **(Hold)** or **(Ris)**.
2. Press * .
3. Dial the external number.
4. Press to store the number.
5. Label your new button.

Internal *autodial*

1. If you are on a call or an open line with dial tone, press or **(Ris)**.
2. Press * .
3. Dial the internal number.
4. Label your new button.

Features

1. If you are on a call, or an open line with dial tone, press or **(Ris)**.
2. Press * .
3. Press and the feature code.
4. Label your new button.

Erasing memory buttons

1. If you are on a call or an open line with dial tone, press or **(Ris)**.
2. Press * .
3. Press to erase the button.

Your Norstar M7208 telephone

Display —————
shows the time, date, call information and guides you while using **Norstar*** features.

Indicators —————
appear beside active lines and features.

Feature button —————
starts or ends a feature.

Release button —————
cancels active calls.

Hold button —————

Dial pad —————

Volume control —————

Memory and line buttons —————
are buttons with indicators for one touch dialing, feature operation or line access.

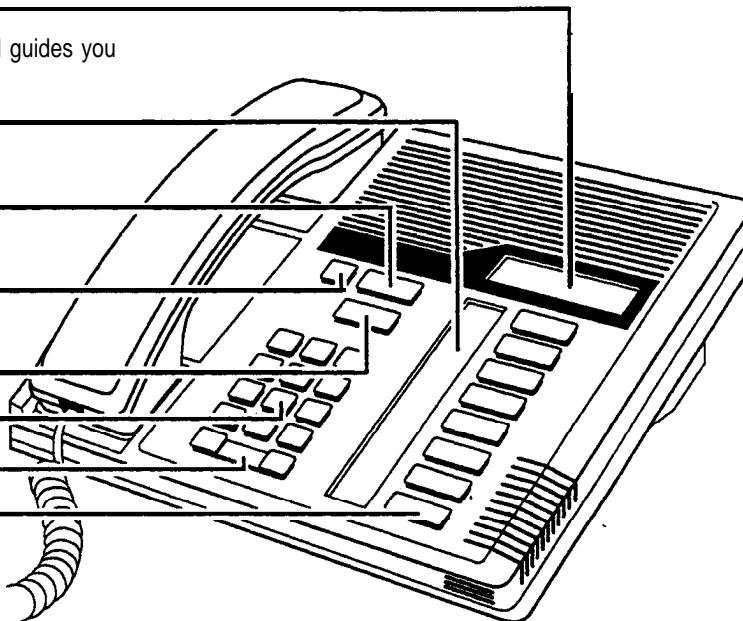

Button Inquiry

Confirm that your memory and line buttons have the correct snap-on caps by checking their programming.

1. Release all calls and open lines with dial tone.
2. Press **Feature** * 0 .
3. Press the button you want to check.
4. Read the display.
5. Press **Feature** when finished.

Adjusting display contrast

1. Press **Feature** * 7 .
2. Press a number on the dial pad for the contrast level you want, the higher the number the higher the contrast level.

Selecting a Ring Type and volume level

1. Press **Feature** * 6 .
2. Press 1, 2, 3 or 4 to hear the different types of rings.
3. While the telephone is ringing, press **softer** **louder** to adjust the volume.
4. Press **softer** to store the ring.

Adjusting receiver or telephone speaker volume

1. Press **softer** **louder** when using the receiver or the speaker.

* Meridian and **Norstar** are trademarks of Northern Telecom.

About line buttons

Norstar systems can have different types of line buttons. Match the line buttons on your telephone with the ones below for instructions on how to use them.

Intercom

Line 1

Internal calls using Intercom buttons

1. Pick up the receiver.
2. If ► appears beside an Intercom button, then dial.
OR
Press an Intercom button without ►, then dial.

External calls using numbered Line buttons

1. Pick up the receiver.
2. When ► appears beside a numbered Line button, then dial.
OR
Press a numbered Line button without ►, then dial.

Note: Internal numbers are supplied by your System Coordinator.

4321

Internal calls using extension buttons

1. Pick up the receiver.
2. When ► appears beside an extension button, then dial.

External calls using extension buttons

1. Pick up the receiver.
2. When ► appears beside the extension button, dial **9** (or your system's external line access code) and the number.

Hold

Holding Calls

1. Press **Hold**, The ► flashes beside the line on hold.
2. Press the line button with the flashing ► to return to the call.
Check the display for confirmation or additional information.

Automatic hold

Calls are put on hold automatically when you switch from one line to another.

Handsfree

This button operates the telephone's built-in microphone and speaker in place of the receiver. Your System Coordinator can program Handsfree to your telephone.

Making calls

1. Press **Handsfree** instead of picking up the receiver.

Switching between Handsfree and handset

1. Press **Handsfree** and replace the handset to switch to Handsfree.
2. Pick up the receiver to switch back.

Using Mute

Programming memory buttons

About memory buttons

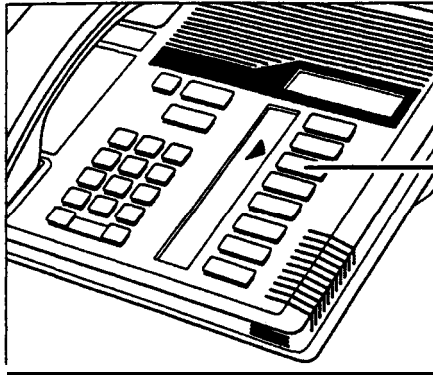

Memory buttons are the buttons with indicators other than line or Handsfree buttons. Memory buttons store telephone numbers or feature codes to give you one touch dialing or feature activation. You can change what a memory button does by just programming it with a new number or feature. You cannot program a line or Handsfree button.

Remember: Press **Feature** * **Q** to check a memory or line button.

Programming memory buttons

External autodial

1. If you are on a call or an open line with dial tone, press **Hold** or **Rls**.
2. Press **Feature** * **1**.
3. Press a memory button.
4. Dial the external number.
5. Press **Hold** to store the number.
6. Label your new button.

Internal autodial

1. If you are on a call or an open line with dial tone, press **Hold** or **Rls**.
2. Press **Feature** * **2**.
3. Press a memory button.
4. Dial the internal number.
5. Label your new button.

features

1. If you are on a call or an open line with dial tone, press **Hold** or **Rls**.
2. Press **Feature** * **3**.
3. Press a memory button.
4. Press **Feature** and the feature code.
5. Label your new button.

Erasing memory buttons

1. If you are on a call or an open line with dial tone, press **Hold** or **Rls**.
2. Press **Feature** * **1**.
3. Press the memory button you want to erase.
4. Press **Hold** to erase the button.

Your Norstar M7310 telephone

Shift button.
for using the top function of a dual-memory button.

Display
shows the time, date, call information and guides you while using Norstar* features.
The lower line of the display is reserved for display button instructions.

Dual-memory buttons
store any two features and/or autodial numbers.

Display buttons

Feature button
starts or cancels a feature.

Release button
cancels active calls.

Hold button

Dial pad

Memory and line buttons
are buttons with indicators for one touch dialing, feature operation or line access.

Volume control

Indicators
appear beside active lines and features.

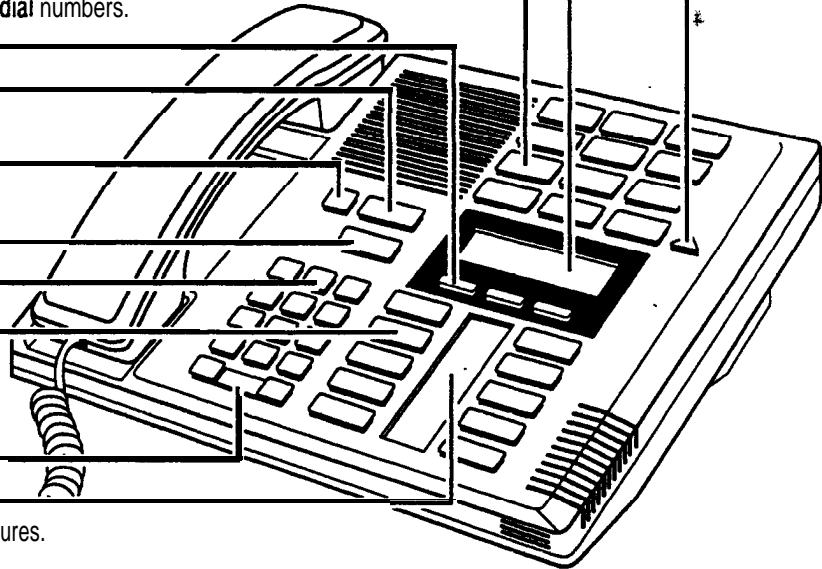

Using display buttons

Display buttons change with each feature you use. The labels for display buttons appear in capital letters directly above them on the second line of the display. A display button with an "OK" label above it is represented as OK in this card.

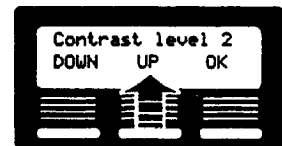

Button inquiry

Confirm that your memory and line buttons have the correct snap-on caps by checking their programming.

1. Release all calls or open lines with dial tone.
2. Press **Feature** * **0**.
3. Press the button(s) you want to check and read the display.
4. Press **Feature** when finished.

Adjusting display contrast

1. Press **Feature** * **7**.
2. Press **UP** or **DOWN** for the level you want.
3. Press **OK** when finished.

Selecting a ring type and volume level

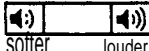
1. Press **Feature** * **6**.
2. Press **1**, **2**, **3** or **4** to hear the different types of rings.
3. While the telephone is ringing, press  to adjust the volume.
4. Press **OK** to store the ring.

* Meridian and Norstar are trademarks of Northern Telecom.

Making calls

About line buttons

Norstar systems can have different types of line buttons. Match the line buttons on your telephone with the ones below for instructions on how to use them.

Intercom

Line 1

Internal calls using Intercom buttons

1. Pick up the receiver.
2. If ► appears beside an Intercom button, then dial.
OR
Press an Intercom button without ►, then dial.

External calls using numbered Line buttons

1. Pick up the receiver.
2. When ► appears beside a numbered Line button, then dial.
OR
Press a numbered Line button without ►, then dial.

Note: Internal numbers are supplied by your System Coordinator.

4321

Internal calls using extension buttons

1. Pick up the receiver.
2. When ► appears beside an extension button, then dial.

External calls using extension buttons

1. Pick up the receiver.
2. When ► appears beside the extension button, then dial **[9]** (or your system's external line access code) and the number.

Hold

Holding Calls

1. Press **[Line ►]** flashes beside the line on hold.
2. Press the line button with the flashing ► to return to the call.
Check the display for confirmation or additional information.

Automatic hold

Calls are put on hold automatically when you switch from one line to another.

Handsfree

This button operates the telephone's built-in microphone and speaker in place of the receiver. Your System Coordinator can program Handsfree to your telephone.

Making calls

1. Press **[Handsfree]** instead of picking up the receiver.

Switching between Handsfree and handset

1. Press **[Handsfree]** and replace the handset to switch to Handsfree.
2. Pick up the receiver to switch back.

Using Mute

1. Press **[Handsfree]** to turn the microphone OFF.
2. Press **[Handsfree]** again to turn the microphone ON.

Dialing without lifting the handset

1. Press a line button without ►, then dial your call.
2. When answered, pick up the receiver, or press **[Handsfree]**.
3. If the call is not answered, or the line is busy, press **[Ris]**.

Programming memory buttons

About memory buttons

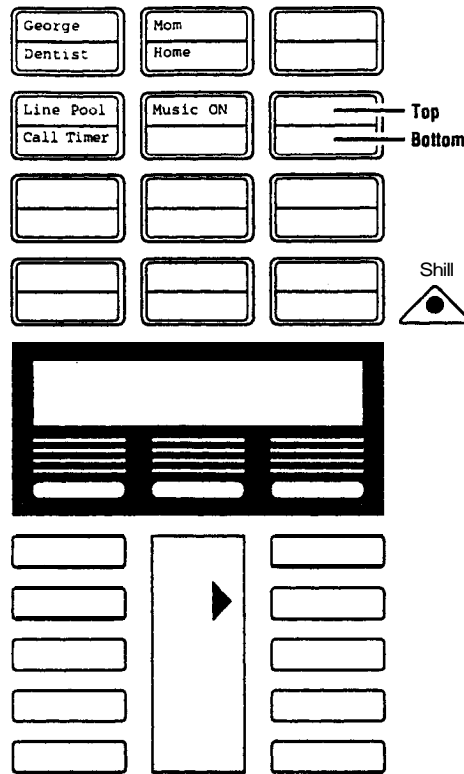

There are two types of memory buttons: single-memory and **dual**-memory. Memory buttons store telephone numbers or feature codes to give you one touch dialing or feature activation.

Dual-memory buttons

To use the bottom function, press the dual-memory button.

To use the top function, press the shift button, then press the **dual**-memory button.

Single-memory buttons

Single-memory **buttons** are the buttons with indicators other than line or Handsfree buttons.

Remember: Press **Feature** * 0 to check a memory or line button.

Programming memory buttons

External **autodial**

1. If you are on a call or an open line with dial tone, press **Hold** or **Rls**.
2. Press **Feature** * 1.
3. Press a memory button.
4. Dial the external number.
5. Press **OK** to store the number.
6. Label your new button.

Internal **autodial**

1. If you are on a call or an open line with dial tone, press **Hold** or **Rls**.
2. Press **Feature** * 2.
3. Press a memory button.
4. Dial the internal number.
5. Label your new button.

Features

1. If you are on a call or an open line with dial tone, press **Hold** or **Rls**.
2. Press **Feature** * 3.
3. Press a memory button.
4. Press **Feature** and the feature code.
5. Label your new button.

Erasing memory buttons

1. If you are on a call or an open line with dial tone, press **Hold** or **Rls**.
2. Press **Feature** * 1.
3. Press the memory button you want to erase.
4. Press **OK** to erase the button.

Your Norstar M7324 telephone

Memory and line buttons

are buttons with indicators for one touch dialing, feature operation or line access.

Display

shows the time, date, call information and guides you while using Norstar* features. The lower line of the display is reserved for display button instructions.

Display buttons

Dial pad

Volume control

Feature button

starts or ends a feature.

Hold button

Release button

cancels active calls.

Indicators

appear beside active lines and features.

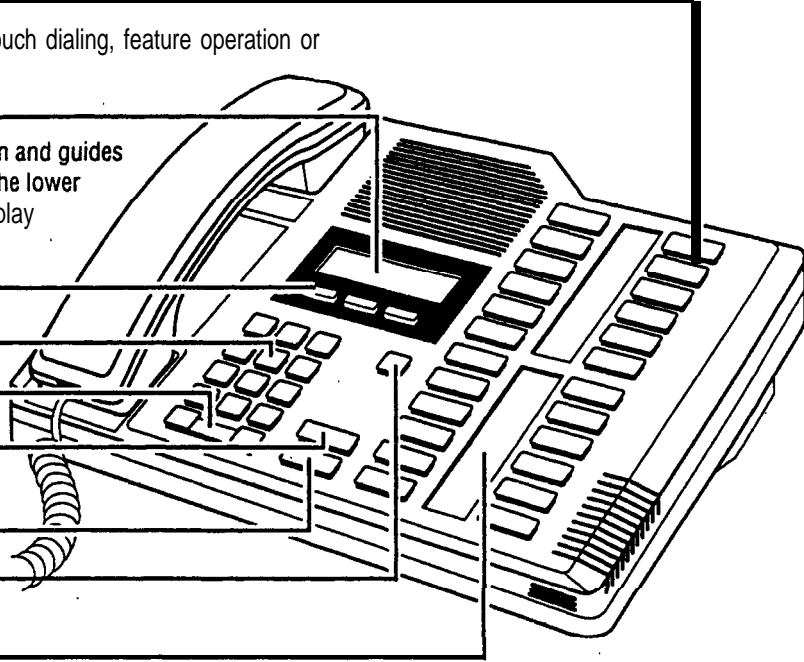

Using display buttons

Display buttons change with each feature you use. The labels for display buttons appear in capital letters directly above them on the second line of the display. A display button with an "OK" label above it is represented as OK in this card.

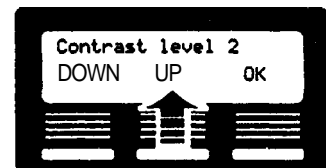

Button inquiry

Confirm that your memory and line buttons have the correct snap-on caps by checking their programming.

1. Release all calls or open lines with dial tone.
2. Press Feature * 0.
3. Press the button(s) you want to check and read the display.
4. Press Feature when finished.

Adjusting display contrast

1. Press Feature * 7.
2. Press UP or DOWN for the level you want.
3. Press OK when finished.

Selecting a ring type and volume level

1. Press Feature * 6.
2. Press 1, 2, 3 or 4 to hear the different types of rings.
3. While the telephone is ringing, press softer or louder to adjust the volume.
4. Press OK to store the ring.

* Meridian and Norstar are trademarks of Northern Telecom.

Making calls

About line buttons

Norstar systems can have different types of line buttons. Match the line buttons on your telephone with the ones below for instructions on how to use them.

Intercom
[L i n e]

Internal calls using intercom buttons

1. Pick up the receiver.
2. If ► appears beside an Intercom button, then dial.
OR
Press an Intercom button without ►, then dial.

External calls using numbered Line buttons

1. Pick up the receiver.
2. When ► appears beside a numbered Line button, then dial.
OR
Press a numbered Line button without ►, then dial.

Note: Internal numbers are supplied by your system coordinator.

4321

internal calls using extension buttons

1. Pick up the receiver.
2. When ► appears beside an extension button, then dial.

External calls using extension buttons

1. Pick up the receiver.
2. When ► appears beside the extension button, then dial [9] (or your system's external line access code) and the number.

Hold

Holding Calls

1. Press **Hold** ► flashes beside the line on hold.
2. Press the line **button with** the flashing ► to return to the call.
Check the display for confirmation or additional information.

Automatic hold

Calls are put on hold automatically when you switch from one line to another.

Handsfree

This button operates the telephone's built-in microphone and speaker in place of the receiver. Your System Coordinator can program Handsfree to your telephone.

Making calls

1. Press **Handsfree** instead of picking up the receiver.

Switching between Handsfree and handset

1. Press **Handsfree** and replace the handset to switch to Handsfree.
2. Pick up the receiver to switch back.

Using Mute

1. Press **Handsfree** to turn the microphone OFF.
2. Press **Handsfree** again to turn the microphone ON.

Dialing without
lifting the handset

1. Press a line button without ►, then dial your call.
2. When answered, pick up the receiver, or press **Handsfree**.
3. If the call is not answered, or the line is busy, press **IRIS**.

Programming memory buttons

About memory buttons

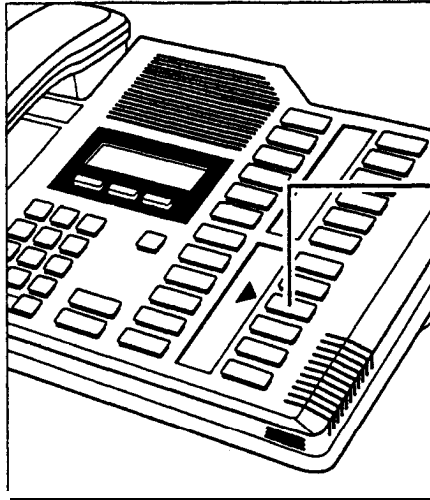

Memory buttons are the buttons with indicators other than line or Handsfree buttons. Memory buttons store telephone numbers or feature codes to give you one touch dialing or feature activation. You can change what a memory button does by just programming it with a new number or feature.

If you have programmed a memory button with an internal number the indicator comes on when the number is busy.

Remember: Press * to check a memory or line button.

Programming memory buttons

External autodial

1. If you are on a call or an open line with dial tone, press or .
2. Press * .
3. Press a memory button.
4. Dial the external number.
5. Press **OK** to store the number.
6. Label your new button.

Internal autodial

1. If you are on a call or an open line with dial tone, press or .
2. Press * .
3. Press a memory button.
4. Dial the internal number.
5. Label your new button.

Features

1. If you are on a call or an open line with dial tone, press or .
2. Press * .
3. Press a memory button.
4. Press and the feature code.
5. Label your new button.

Erasing memory buttons

1. If you are on a call or an open line with dial tone, press or .
2. Press * .
3. Press the memory button you want to erase.
4. Press **OK** to erase the button.

Glossary

A

Access code: A sequence of characters used to gain entry into any type of **Norstar** system programming.

Administration: A program that lets one person in your office (the System Coordinator) assign and maintain certain settings on the **Norstar** system.

Administration access code: A code required to access Administration programming. You may be asked for an Administration password.

Administration password: A one- to six-digit password that prevents unauthorized access to Administration programming. The Administration password can be assigned and changed in Administration programming.

Alarm code: A number that appears on the Alarm telephone's display, informing you that **the KSU** has detected a fault in the system.

Alarm telephone (Alarm set): A telephone that is designated to receive reports of **Norstar** system problems. This function is usually assigned to a Prime telephone, but this can be changed in Configuration programming.

Allow Redirect: A sub-heading in Administration programming that allows you to set whether Line Redirection can be used from that telephone.

Analog Terminal Adapter (ATA): A device that permits the connection of analog telecommunication devices such as FAX machines, answering machines, and single line telephones to the **Norstar** system. Programmed defaults for the **ATA** are automatically assigned by the **Norstar** system.

Answer button: A telephone button with an indicator that is used to monitor another telephone. The Answer button indicates incoming calls destined for the other telephone. Someone working at a telephone with Answer buttons (a receptionist, for example) can receive all ringing and visual indication of incoming calls for other telephones, and answer those calls when necessary. One telephone can have up to four Answer buttons. An Answer button is automatically assigned to a telephone when that telephone is assigned an Answer DN.

216 / Glossary

Answer DN: A Directory Number (DN) of a telephone that is monitored by an Answer button. Up to four Answer **DNs** can be assigned to a telephone by the Customer Service representative.

Autobumping: A setting that **determines** what the system does with new Call Log items when your Call Log is full. When Autobumping is **ON**, a new log entry causes the oldest entry to be deleted. If Autobumping is **OFF**, your **Norstar** system does not log calls when your log is full.

Autodial button: A memory button that, if programmed, provides one-touch dialing of external or internal numbers..

Autolog options: A feature that allows you to select the type of calls that are stored in your Call Log. You can choose to log calls that were not answered by anyone within the system, to log calls that were unanswered at this telephone but answered elsewhere in the system, to log all calls answered and not answered at this telephone, or to not have calls automatically logged.

Automatic Dial: A feature that allows you to dial without having to pick up the receiver or select a line. You must have a Prime line to use Automatic Dial.

Automatic Handsfree: A feature that automatically activates Handsfree operation when you make or answer a call. Automatic Handsfree is assigned in Administration programming.

Automatic Hold: A feature that automatically places an active call on hold when you select another line. Automatic Hold is programmed by your Customer Service representative.

Automatic Privacy: See Privacy.

Automatic Telephone Relocation: A feature that lets a telephone retain its personal and system programming when it is plugged into a different **Norstar** modular jack. Automatic telephone relocation is enabled by your Customer Service representative.

Auxiliary ringer: A separate external telephone ringer or bell that can be programmed to ring when a line or a telephone rings. An auxiliary ringer may be programmed to ring only when the system is in a particular service mode. Programming of an auxiliary ringer is done in Administration programming after the feature has been enabled by your Customer Service representative.

B

Background Music: A feature that lets you hear music from the speaker of your **Norstar** telephone. It is available only if a music source has been attached to the KSU and the feature has been enabled by your Customer Service representative.

Busy Lamp Field (BLF): A device with a liquid crystal display (LCD) panel of indicators that shows the status of up to 24 telephones in the **Norstar** system. The **BLF** shows a telephone as busy if it is active on a call, has Do Not Disturb turned ON, or is being used for programming. The **BLF** attaches to the **M7310** Telephone.

Button caps: Interchangeable plastic caps that fit over the buttons of **Norstar** telephones. They are used to indicate the features programmed onto each programmable memory button. Button caps are either pre-printed or have clear windows that allow you to label the buttons.

Button Inquiry: A feature that allows you to check the function of each programmable button on your **Norstar** telephone.

Bypass Restrictions: A setting that allows you to override any Call Restrictions applied to specific System Speed Dial numbers. Bypass Restrictions can be turned on in Administration programming.

C

Call Forward: A feature that forwards all the calls arriving at your telephone to another telephone in your **Norstar** system. To have calls forwarded outside the system, use Line Redirection.

Call Forward No Answer: A feature that forwards all calls arriving at your telephone to another designated telephone in your **Norstar** system after a specific number of rings. Call Forward No Answer is assigned in Administration programming.

Call Forward On Busy: A feature that forwards all calls at your telephone to another designated telephone if your telephone is busy. This feature is assigned in Administration programming.

Call Forward Override: A feature that allows you to call someone and ask them to stop forwarding their calls to you.

Call Information: A feature that allows you to display information about incoming calls. For external calls, you can display the caller's name, telephone number and the line name. For an internal call, you can display the name of the caller and their internal number. You can obtain information about ringing, answered, or held calls.

Call Log: A feature that accesses a record of incoming calls. The log could contain the following information for each call: sequence number in the Call Log, name and number of caller, long distance indication, indication if the call was answered, time and date of the call, number of repeated calls from the same source, and name of the line that the call came in on. See **Autobumping**, **Autolog** options, **Enter Call Log**, and **Logit** for further information.

Call Park: A feature that allows you to place a call on hold so that someone can retrieve it from any other telephone in the **Norstar** system by selecting an internal line and entering a retrieval code. The retrieval code appears on the display of your telephone when you park the call. You can park up to nine calls on the system at one time.

Call Park Callback: See **Callback**.

Call Park prefix: The first digit of the retrieval code of a parked call. This digit cannot conflict with the first digit of any existing **DNs**, **Line Pool** access codes, the **Direct-dial** digit, or the external line access code. The default **Call Park** prefix digit is "1". It may be set to none, in which case **Call Park** is disabled. **Call Park** prefix is assigned by your **Customer Service** representative.

Call Pickup Directed: A feature that lets you answer a call ringing at any **Norstar** telephone by entering the internal number of that telephone before taking the call. **Call Pickup Directed** is activated by your **Customer Service** representative.

Call Pickup Group: See **Pickup Group**.

Call Queuing: A feature that allows you to answer calls in order of priority if you have several calls waiting at your telephone. Priority is given to external incoming calls, followed by **callback** and **camped** calls.

Callback: A feature that returns parked, **camped** or transferred calls to your telephone if they are not answered at another telephone. How long the system will wait before **Callback** occurs is set by your **Customer Service** representative.

Camp-On: A feature that lets you re-route a call to a telephone even if all the lines on that telephone are busy. To answer a **camped** call, use **Call Queuing** or select a line if the **camped** call appears on your telephone. Priority is given to **queued** calls over **camped** calls.

Camp timeout: The length of a delay before a **camped** call is returned to the telephone that **camped** the call. This delay is set by your **Customer Service** representative.

Capabilities: A section heading in Administration programming, that covers the dialing filters, remote access packages, set abilities, and line abilities that can be assigned to **Norstar** lines, telephones, or Class of Service passwords.

Central Answering Position (CAP): An M7324 Telephone that has been designated a CAP by your Customer Service representative. The CAP provides backup answering and can be used to monitor the telephones within a **Norstar** system. One or two CAP modules can be attached to a CAP to increase the number of lines it can handle.

Central Answering Position (CAP) module: A module connected to an M7324 Telephone that provides 48 additional buttons that can be used as **Autodial** buttons or Feature buttons. A maximum of two CAP modules can be connected to a single M7324 Telephone.

Class of Service (COS): A set of **Norstar** features and lines available to the user for a call. The Class of Service for a call is determined by the Dialing Filters and Remote Access Packages assigned to the telephone in Administration programming. The Class of Service for a call can be changed by entering a six-digit Class of Service password. (Internal users cannot change their access to features with a COS password, only their dialing filters.) Class of Service and Class of Service passwords are assigned in **Administration** programming. See Remote Access.

Class of Service password: A six-digit code that lets you switch from your current Class of Service to one that lets you dial numbers prohibited by your current Class of Service.

Conference: A feature that allows you to establish a three-person call at your **Norstar** telephone.

Conference using privacy: A feature that allows you to turn privacy OFF for a call allowing another person with the same line to press the line button and join in your conversation, forming a conference. Normally your calls are private; no one else can pick up your line and join in.

Contrast Adjustment: A feature that allows you to set the contrast level of your telephone display.

220 / Glossary

Control telephone: A telephone that can place the lines for which it has responsibility in or out of a Service Mode. A telephone is programmed as a Control telephone and has lines assigned to it in Administration programming.

COS: See Class of Service.

Cursor: A short horizontal line that appears on the **Norstar** telephone display to indicate that characters can be entered using the dial pad.

D

Data Communications Interface (DCI): A **Norstar** device that lets you attach an RS-232 data device to your **Norstar** system.

Data terminal: A device, such as a modem, that can be used to transfer data instead of sound over a telephone network. You cannot use **Norstar** programming to set up such devices. See the documentation that accompanies the device.

Date: See Show Time or Time and Date.

Defaults: The settings for all **Norstar** features when the system is first installed. Settings are changed from their defaults in Administration programming and by your Customer Service representative. In this manual, default settings are shown in bold text.

Delayed Ring Transfer (DRT) to Prime: A feature that transfers an unanswered call on an external line to the Prime Telephone associated with that line after a specified number of rings. This feature is activated by your Customer Service representative.

Dial mode: The dialing mode of a line can be either Tone or pulse. Pulse is traditionally used by rotary dial telephones. Tone is also referred to as dual-tone multi frequency (DTMF) tones. Dial mode can be programmed by your Customer Service representative.

Dialing filter: A feature that prevents certain telephone numbers from being dialed through a combination of restrictions and exceptions. Dialing filters can be applied to lines (line filters, remote filters), to telephones (set filters), to specific lines on a telephone (line/set filters), and to Class of Service passwords (user filters, remote filters). The **Norstar** Modular system can handle up to 100 dialing filters.

Direct Inward System Access (DISA): A feature that lets remote users dial directly into the **Norstar** system and use **Norstar** features. Callers hear stuttered dial tone and are required to enter a Class of Service password to gain access to the system. See Remote Access.

Direct-dial: A feature that lets you dial a designated telephone in your **Norstar** system with a single digit. As many as five Direct-dial telephones can be established. Each telephone in the system is assigned to one Direct-dial telephone. There is a single, system wide digit for calling the assigned Direct-dial telephone of any telephone. Direct-dial telephones are established in Administration programming. Telephones are assigned to a Direct-dial telephone in Administration programming.

Direct-dial number: A digit used system wide to call a Direct-dial telephone. The digit is programmed by your Customer Service representative.

Directed Pickup: See Call Pickup Directed.

Directory Number (DN): A unique number that is automatically assigned to each telephone or data terminal. The DN, also referred to as an internal number, is often used to identify a telephone when settings are assigned during programming. Default DN assignments start at 21 in a two-digit (non-expanded) system and 221 in a three-digit (expanded) system.

DISA: See Direct Inward System Access.

DISA DN: A received number assigned to the **Norstar** Direct Inward System Access facility. If a caller dials a number that is assigned to the **DISA DN**, the caller hears stuttered dial tone and must enter a Class of Service Password. Once the password is accepted, the caller hears system dial tone and can use Remote Access features. See Remote Access.

Display: A liquid crystal display (LCD) on the **Norstar** telephone that guides you through feature operation and programming.

Display button: One of three buttons located directly beneath the display on **M7310** and **M7324** Telephones. During feature operation or programming, some or all of these buttons may be used to provide further options. If an option is available, it is shown in the bottom line of the two-line display, directly above the corresponding display button. Display buttons are represented in this manual as underlined capitals, e.g. OK.

Display digits: A sub-heading in Administration programming that allows you set whether an assigned name or the actual number is displayed when someone uses a system speed dial code.

DN: See Directory Number.

DRT delay: The number of rings before a Delayed Ring Transfer occurs. This is assigned by your Customer Service representative.

DRT to Prime: See Delayed Ring Transfer to Prime.

E

Emergency Telephone: A single-line telephone (also referred to as a **500/2500** telephone) that becomes active when there is no power to the Key Service Unit.

Event message: An item stored in the system log and displayed during a Maintenance session. Event messages record a variety of events and activities in the **Norstar** system.

Exceptions: A component of a Dialing filter. Exceptions are numbers you can dial even if they are forbidden by a more general Restriction. See Restrictions.

Expanded system: A **Norstar** system with an Expansion Cartridge.

Expansion Cartridge: A cartridge which connects Trunk modules and Expansion modules to the Key Service Unit.

External call: A call to a destination outside the **Norstar** system.

External Call Forward: See Line Redirection.

External code: The number you dial to get an external line. The default is 9, but this can be changed by your Customer Service representative. You do not always need an external code. It is primarily to support the **M7100** Telephone and single-line telephones using an Analog Terminal Adapter (**ATA**).

External line: A line on your **Norstar** telephone used for making calls to destinations outside the **Norstar** system.

External music source: See Music source.

External paging: A feature you can use to make voice announcements over an externally-mounted loudspeaker connected to the Key Service Unit. The external speaker is not a **Norstar** component and must be supplied by the customer.

Extra-dial telephone: A heading in Administration programming that allows you to assign an extra Direct-dial telephone when a service mode is active. You can have one Extra-dial telephone for each of the three service modes.

F

Feature button: A button that activates many **Norstar** features when it is pressed and followed by a Feature code. The Feature button is also used to exit a feature.

Feature Cartridge: A replaceable cartridge containing the **Norstar** features. The Feature Cartridge, a combination of a Data Cartridge and a Software Cartridge, is inserted into the Key Service Unit.

Feature code: A number that is used to activate a particular feature.

Forward: See Call Forward.

Forward delay: The number of rings before an unanswered call is forwarded to another telephone when the Call Forward No Answer feature is ON. Forward delay is assigned in Administration programming.

Forward No Answer: See Call Forward No Answer.

Forward On Busy: See Call Forward On Busy.

Full Autohold (on idle line): A feature that, when activated, puts a line on hold when you select an available line and then do something that selects another line. Full **Autohold** is activated by your Customer Service representative.

Full Handsfree: See Handsfree.

G

Group Listening: A feature that allows you to have others in your office hear a caller through your phone's speaker. The caller hears you only when you speak into the receiver and cannot hear other people in the office.

H

Handsfree: A feature you can use to make calls without using the telephone receiver. Full Handsfree is activated in Administration programming. When it is activated, a **Handsfree/Mute** button is automatically assigned to the telephone.

Handsfree (HF) Answerback: A feature that automatically turns ON the microphone at a telephone receiving a Voice Call so that the person receiving the call can respond without lifting the receiver. Handsfree Answerback is activated in Administration programming.

Handsfree/Mute button: See Handsfree.

Headset: A head-mounted or ear-mounted telephone receiver that is used instead of the hand-held receiver. Headsets are not **Norstar** components and must be supplied by the customer.

Held (Line) Reminder: An indication that an external call has been placed on hold for a certain period of time. Your **Norstar** telephone rings and displays the message

Held call 1. The Held Line Reminder feature and Remind delay are programmed by your Customer Service representative.

HF Answerback: See Handsfree Answerback.

Hold button: A button used to suspend calls so that the person using the telephone can perform another task without disconnecting the caller.

Hookswitch Flash: See Link time.

Host System Signaling: (Also referred to as End-to-End Signaling.) **Norstar** telephones can access a remote system or dial a number on an alternate carrier by means of Host feature activation, such as Link, Pause and Run/Stop.

Hotline: A feature that automatically calls a pre-assigned number when the telephone's receiver is lifted or the **Handsfree/Mute** button is pressed. A Hotline number can be an internal or external number. Hotline is programmed in Administration programming.

I

I/C: An abbreviation of Intercom button.

Installer: A person who installs the **Norstar** equipment, and performs System Startup and certain programming actions. The Installer or the System Coordinator can program Administration settings.

Intercom button: A button that provides access to internal lines used for calls within a **Norstar** system and access to external lines through a Line Pool or external code. A telephone may be assigned zero to eight Intercom buttons. This is done by the Customer Service representative.

Intercom keys: See Intercom button.

Internal line: A line on your telephone dedicated to making calls to destinations inside your **Norstar** system. An internal line may still connect you with an external caller if you use it to access a line pool or to pick up a call using **Norstar** call handling features such as Call Park or Call Pickup Directed.

Internal number: A number (also referred to as a Directory Number or DN) that identifies a **Norstar** telephone or device.

Internal user: A person using a **Norstar** telephone within a Not-star system.

K

Key Service Unit (KSU): The central hardware component in the **Norstar** system. The KSU has its own processor and memory, and provides a physical point of connection for the various types of devices, telephones, and expansion modules used in **Norstar**. The KSU can function on its own as a basic system (with 24 **Norstar** telephones and 8 external lines), or with the addition of a Trunk Module (TM) that supports more external lines, or a Station Module (SM) that supports more **Norstar** telephones.

L

Line: The complete path of a voice or data connection between one telephone (or other device) and another.

Line abilities: The heading in Administration programming under which you assign Line Filters, Remote Filters, and Remote Access Packages to lines.

Line filter: See Dialing filter.

Line names: The sub-heading in Administration programming that allows you to assign names to external lines.

Line number: A number that identifies an external line. The total number of lines depends on how many Trunk Modules are installed.

Line Pool: A group of lines used for making external calls. Line Pools provide an efficient way of giving a telephone access to external lines without taking up many line buttons. A line is assigned to be a member of a Line Pool by your Customer Service representative.

Line Pool access code: A number that identifies a Line Pool. Line Pool access codes are assigned by your Customer Service representative.

Line Profile: A feature you can use to review the settings programmed to lines by the Customer Service representative and by Administration programming. The settings cannot be changed with this feature. Line profile is available only on **M7310** and **M7324** Telephones.

Line Redirection: A feature that allows you to redirect all calls on an incoming line to a destination outside the **Norstar** system. Once a line is redirected it cannot be answered within the **Norstar** system. The system may be set up to give a brief ring when a call comes in on a redirected line. This feature differs from Call Forward in two ways. It redirects only external calls (not internal calls) and it redirects calls to destinations outside the system. Call forward redirects calls only to destinations inside the **Norstar** system. See Call Forward and Redirect Ring.

Link time: A specific time delay that allows access to PBX features through a **Norstar** system. Link time is also referred to as a “Hookswitch Flash” or “Recall”. Link time is assigned by your Customer Service representative.

Logit: A feature that allows you to manually log call information when you are connected to a call.

M

M7100 Telephone: A telephone that has a one-line display and one programmable memory button without an indicator.

M7208 Telephone: A telephone that has a one-line display and eight programmable memory buttons with indicators.

M7310 Telephone: A telephone that has a two-line display, three display buttons, 10 programmable memory buttons with indicators, and 12 dual-memory programmable buttons without indicators. An **M7310 Telephone** can be equipped with a **Busy Lamp Field**.

M7324 Telephone: A telephone with a two-line display, three display buttons, and 24 programmable memory buttons with indicators. An **M7324 Telephone** can be equipped with a CAP module.

M7900 Telephone: A telephone with a touch-screen display that replaces the display and memory buttons of other **Norstar** telephones. It provides simplified access to **Norstar** Features and an interface to computer driven applications.

Maintenance: A type of programming you can use to diagnose and repair problems in the **Norstar** system.

Maintenance requires no programmable settings.

Memory buttons: The buttons that can be programmed to dial frequently used features or numbers automatically. See **M7100**, **M7208**, **M7310**, **M7324** and **M7900 Telephone** entries for their exact memory button configurations.

Message: A feature that allows you to indicate to another internal user that you would like them to call you.

Music source: A radio or other source of music that can be connected to the Key Service Unit to provide music for the Music on Hold and Background Music features. A music source is not part of the **Norstar** system and must be supplied by the customer.

N

Names: A feature that allows you to assign System Speed Dial numbers, external lines, telephones, and Service Modes in Administration programming. You can use up to sixteen characters to name a System Speed Dial number, and seven characters to name a telephone, line, or Service Mode. If a Name has not been assigned, the line number or DN appears on the display instead of a Name.

Night Service: See Service Modes.

Norstar Programming

Overlay: A paper template that is placed over the top four memory buttons with indicators on the M7310 or M7324 Telephone during programming. The overlay labels indicate the special function that each of the four buttons takes on during programming.

O

On hold: A setting that controls whether external callers hear music, periodic tones, or silence when they are placed on hold. This setting is programmed by your Customer Service representative.

Overlay: See **Norstar** Programming Overlay.

P

Page: A feature you can use to make announcements over the **Norstar** system. You can choose Internal Page (announce over the telephone speakers), External Page (announce over an externally-mounted, customer-supplied loudspeaker), or both Internal and External Page.

Page Zone: An area in the office that receives internal Page announcements independently of the rest of the office. Each Page Zone is identified by a number. Telephones are assigned to Page Zones in Administration programming.

Park prefix: See Call park prefix.

Park timeout: A delay before an unanswered parked call returns to the telephone that parked it. Park timeout is set by your Customer Service representative. See Call Park.

Password: A specific sequence of digits that you enter to gain access to **Norstar** programming, to override dialing restrictions, or to use Remote Access with DISA. Passwords are also required for System Startup and Administration programming. See **Class** of Service password.

Pause: A character that inserts a **1.5-second** delay in a dialing sequence on an external line.

Personal Speed Dial: A two-digit code (71-94) that can be programmed to dial external telephone numbers. Personal Speed Dial numbers are programmed for each telephone, and can be used only at the telephone on which they are programmed.

Pickup Group: A **group** of telephones. A telephone can be placed into one of nine Call Pickup Groups. A call ringing at a telephone within a Pickup Group can be picked up at any other telephone within the same Pickup Group. A telephone is assigned to a Pickup Group in Administration programming.

Pool: See Line Pool.

Pre-dial: A feature that allows you to enter a number and check it on your telephone display before it is actually dialed. If the number is incorrect, you can edit it. The number is dialed only when you pick up the receiver or select a line.

Prime line: A line on your telephone that is automatically selected when you lift the receiver, press the Handsfree/Mute button or use an external dialing feature. A Prime line is assigned to a telephone by your Customer Service representative.

Prime telephone (Prime set): A telephone that provides backup answering for incoming calls on external lines. The Prime telephone for a line will ring for any unanswered calls on that line. A Prime telephone is assigned to a line by your Customer Service representative.

Priority Call: A feature you can use to make a Voice call to a telephone that is idle, busy or has Do Not Disturb activated. This feature is enabled for a telephone in Administration programming.

Privacy: A feature that determines whether a **Norstar** user may select a line in use at another telephone and join an established call. Privacy is set by your Customer Service representative, but can be turned ON and OFF by users during individual calls.

Private line: See Private to.

Private network: A telephone network consisting of owned or leased telephone lines used to connect different offices of an organization independently of the public network.

Private to: A line assigned to one telephone as a Private line by your Customer Service representative. The line cannot appear on any other telephone, except the Prime telephone for that line. Private lines cannot be placed into Line Pools.

Programming: A series of procedures that set the way the **Norstar** system works. Programming includes system-wide settings and individual telephone and line settings.

Programming Overlay: See **Norstar Programming Overlay**.

Programming reminder: A chart on which you can record some commonly-used settings from Administration programming to keep the **Norstar** system's records up-to-date.

Public line: An external line that can be assigned to any telephone and to many telephones. A line is assigned as Public by your Customer Service representative.

Public network: The regular telephone network that connects most homes and businesses.

R

Recall: See Link time.

Receiver: The handset of a telephone.

Redirect ring: A sub-heading in Administration programming that allows you to set whether a line that has been redirected through Line Redirection gives a short ring on those telephones on which the line appears.

Remind delay: A feature that causes a telephone to beep and display the message

Hei d call when a call has been on hold for a programmable period of time. This period is the Remind delay, and is programmed by your Customer Service representative.

Remote access: The ability to dial into a **Norstar** system from outside the system and make use of selected **Norstar** features. The lines, features, and dialing capabilities available to a remote user are determined by the Class of Service. If the remote access line is answered with DISA, the user must enter a Class of Service password to gain access to the **Norstar** system's features.

Remote access dial filter: See Remote filter.

Remote access package: A sub-heading in Administration programming that allows you set **up access** to Paging and Line Pools for remote users.

Remote capability: A subset of **Norstar** features that is available to users connected through Remote Access.

Remote filter: A Dialing filter applied to a line in order to control which digits can be dialed during an incoming remote access call. It is the equivalent of a Telephone filter for a remote user.

Remote paging: A feature that allows remote users to use the **Norstar** paging feature. Access to this feature is governed by the **Class of Service** for the call. See **Remote Access** and **Class of Service**.

Remote User: A person who calls into a **Norstar** system from a telephone outside that system and uses **Norstar** features or lines. See **Remote Access**.

Restrictions: A component of a **Dialing filter**. Restrictions are numbers you cannot dial when that **Dialing filter** is in effect. See **Exceptions**.

Ringing: A programming function done by your **Customer Service** representative that assigns a line to ring or not ring at a telephone. If a line has been assigned as "No ring", an incoming call is shown only by a flashing indicator.

Ringing Telephone (Ringing Set): A telephone that has been assigned to ring when a line has been placed into a **Service Mode**. **Ringing Telephones** are assigned in **Administration programming**.

RI's button: A button that ends a call in the same way that hanging up the receiver does. It may also be used to end **Startup**, **Administration programming**, **Maintenance sessions** and **feature operations**.

Run/Stop: A character that creates a breakpoint in a programmed external dialing sequence. When you press a programmed key, the system dials the number up to the **Run/Stop**. When you press it again, the system dials the digits following the **Run/Stop**.

S

SAPS: See **Station Auxiliary Power Supply**.

Selective line redirection: See **Line Redirection**

Service Modes: A feature that provides special ringing and telephone access after normal office hours, or when there are few people available to answer calls. Certain features become active when one or more lines are placed into a **Service Mode**. **Service Modes** settings are assigned in **Administration programming**.

Set: A telephone.

Set ability: A sub-heading in **Administration programming** under which **set filters**, **line/set filters**; and a variety of system features are assigned to individual telephones.

Set Copy: A heading is Configuration programming that allows you to copy programmable settings from one telephone to another of the same type. Set Copy provides two options: duplicating System Data and User Data, or duplicating System Data only. Set Copy does not provide the same copy capability as the **copy** button, which is more selective of the settings that can be duplicated:

Set filter: See Dialing filter.

Set Names: A sub-heading in Administration programming that allows you to assign Names of up to seven characters to telephones.

Set Profile: A feature you can use to review the settings that have been programmed by your Customer Service representative and by yourself in Administration programming. The settings cannot be changed with this feature. Set Profile is available only on the **M7310** and M7324 Telephones.

Set Relocation: See Automatic Telephone Relocation.

Shift button: A small triangular button beside the dual-memory buttons on the upper half of the **M7310** Telephone. Press the shift button to store or access features on the top half of the dual-memory buttons.

Show Time: A feature that allows you see the current date and time on the **Norstar** telephone display while you are on a call.

Station: An individual telephone or other **Norstar** device.

Station Auxiliary Power Supply (SAPS): A device which provides power to a **Norstar** telephone that is connected more than 305 m (1000 ft) and less than 760 m (2500 ft) from the Key Service Unit, or to a CAP module.

Supervised line: A line for which disconnect supervision is enabled. If an external caller hangs up, the **Norstar** system detects the disconnection and hangs up its line also.

System Coordinator: A person responsible for customizing the **Norstar** system through Administration programming and for helping co-workers use the **Norstar** system.

System Data: An option in the Set Copy function. System Data refers to the system settings that apply to all telephones and lines. System Data consists of the programmable settings from System Startup and Administration programming. It also includes the setting programmed by your Customer Service representative.

System Speed Dial: In Administration programming, a heading under which you can assign up to 70 numbers as System Speed Dial numbers.

System Speed Dial Code: A two-digit code (01 to 70) that can be programmed to dial a telephone number up to 24 digits long. System Speed Dial codes are programmed for the entire **Norstar** system in Administration programming.

System Speed Dial Name: A sub-heading in Administration programming under which you can assign a name to a System Speed Dial number.

System Startup: A procedure that initializes the system programming to defaults. When a **Norstar** system is first installed and powered up, System Startup must be performed before any programming can be done.

T

Tandem call: A call established when a remote user dials into the **Norstar** system and uses the system to place an outgoing call. The combination of the incoming and outgoing calls forms a tandem call. See Remote Access.

Target line: A line dedicated to receiving calls from outside the **Norstar** system.

TCM line (Time Compression Multiplexing line): A two-wire digital station loop joining the cross-connect at the Key Service Unit to a telephone.

Telephone lock (Set lock): A feature that allows you to limit the number of features that may be used or programmed at a telephone. Full telephone lock allows very few changes or features, Partial telephone lock allows some changes and features, and No telephone lock allows any change to be made and any feature to be used. Telephone lock is assigned in Administration programming.

Time and Date: A display description. The current Time and Date appear on the display of idle **Norstar** telephones. The Time and Date can be changed in Administration programming.

Transfer: A feature that lets you redirect a call to another telephone in your **Norstar** system, over a network or outside your **Norstar** system. There are four types of Transfer; Transfer using Hold, Transfer with Announcement, Transfer without Announcement, and transfer using Unsupervised Conference.

Transfer Callback: A feature that returns a transferred call if it is not answered after a specific number of rings. The number of rings is programmed by your Customer Service representative. Transfer Callback does not apply to calls transferred externally.

Trunk: A physical connection between the **Norstar** system and the outside world using -either the public telephone system or a private network.

Trunk Answer: A feature you can use to answer a call on any line that has an active Service Mode, even if that line does not appear on your telephone. Trunk Answer is activated in Administration programming.

U

Unsupervised line: A line for which disconnect supervision is disabled. If an external caller hangs up, the **Norstar** system does not detect the disconnection and does not hang up its line. See Disconnect Supervision.

User Data: An option in the Set Copy feature. User Data refers to the personal settings that are unique to an individual telephone, and are not programmed by the Customer Service representative or Administration programming. User Data is programmed at each telephone. These settings, for example, include Personal Speed Dial and the assignment of programmable memory buttons.

User Filter: See Dialing filter.

V

Voice Call: A feature you can use to make an announcement or begin a conversation through the speaker of another telephone in the **Norstar** system. The telephone you call does not ring. Instead, the person you call hears a beep and then your voice. Their telephone beeps periodically to remind them that their microphone is open.

Index

A

- Access Code
 - External line 123
- Access denied**
 - Conference 112
 - Speed dial 169
- Accidental Disconnect
 - Protection 172
- Administration
 - Dialing filters 35
 - Direct-Dial 34
 - Names 28
 - Overview 16
 - Programming reminders 67
 - Service Modes 51
- Alarm telephone
 - description 164
- Allow Redirect 45, 143
 - Programming 45
- All ready joined**
 - Call Pickup 105
 - Dialing 125
- All ready Parked**
 - Call Park 102
- Alternate Language 118
- Answer buttons 105, 154
- Answerback 43
- ATA
 - Long tones 147
- Autobumping 95
- Autodial 155
 - Buttons 155
 - Feature description 85
 - Host System Signaling 87
 - losing data after power failure 86

- Autodial full**
 - Autodial 85
 - Speed dial 169
- Autolog/Show Voice Message
 - logging set 59
- Automatic Call information 58
- Automatic Dial 117
- Automatic Handsfree 116
 - programming 43
- Automatic telephone relocation
 - 172
- Auxiliary Ringer
 - programming 44
 - Service Modes 54

B

- Background Music 172
- Blocking calls 49
- Button **erased**
 - Autodial 86
- Button Inquiry
 - Feature description 129
- Buttons
 - Answer 154
 - Autodial 155
 - Erasing programming 129
 - Feature 154, 155
 - H o l d 1 5 4 indicators 79
 - Line 155
 - Memory 154
 - Programmed 155
 - Release 155
 - Volume 155

C

- Call **l**ocked
 - Priority call 160
- Call Display Information 3, 77
 - first display 59
- Call Display services 3
- Call Forward
 - Feature description 88
 - No Answer 45, 88
 - On Busy 44, 88
 - Override 88
- Call Identification 56, 58, 59
- Call Information
 - Feature description 91
- Call Log 6
 - Autobumping 95
 - call from 96
 - clearing passwords 59
 - defaults 56
 - displays 98
 - erase items 96
 - Feature description 93
 - Log Space 59
 - Logging Options 93
 - Logit 94
 - navigate 96
 - optional password 97
 - reset all Logs 56
- Call Park 78
 - displays 102
 - Feature description 102
- Call Pickup 78
 - Assigning groups 106
 - displays 104
 - Feature description 104
 - Priority of alerting calls 106
- Call Pickup (group)
 - programming 43
- Call Queuing
 - Feature description 107
 - priorities 107
- Callback 77
- Calls
 - Incoming 83
- Camp** denied
 - Camp on 108
- Camp On
 - Call Queuing 109
 - displays 108
 - Feature description 108
 - ringing 79
- Can't **ring** again
 - Dialing 125
- Can't send **msg**
 - Message 150
- Cancel
 - Feature 76
- Cancel **denied**
 - Message 150
- Cancel for
 - Message 151
- CAP module 164
- Capabilities
 - Dialing filters 35
 - Line filters 50
 - Remote filters 50
 - User filter 50
- Class of Service 173,185
- Class of Service passwords
 - copying data 49
 - for internal Users 48
 - Line filter 50
 - number of 49
 - Remote package 50
 - Security 48
 - User filter 50
 - with **DISA** DN 48
- Conference
 - displays 112

-
- Feature description 110
 - on M7100 telephone 113
 - Transferring 112
 - with Privacy 110
 - Conference busy**
 - Conference 112
 - Configuration 173
 - Contrast Adjustment 116
 - Control telephone 165
 - assigning to lines 51
 - Copy**
 - line programming 61
 - telephone programming 61
 - COS Line filters (See Line filters (COS))
 - COS Password
 - Changing 115
 - displays 115
 - Feature description 115
 - Customizing **Norstar** 13, 16
 - Customizing the telephone
 - Contrast Adjustment 116
 - Dialing modes 117
 - Handsfree 116
 - Language 118
 - Moving line buttons 119
 - Pulse/Tone Dialing 120
 - ring type 120
 - ring volume 121
- D**
-
- Delayed Ring Transfer 77
 - Denied in **admin**
 - Call Pickup 105
 - Priority call 160
 - Service modes 162
 - Dialing
 - direct dial 123
 - displays 125
 - Pulse or Tone 120
 - Dialing filters
 - deleting 38
 - Programming 35
 - Dialing Modes
 - Automatic 117
 - Pre-Dial 117
 - Standard 117
 - Direct-dial telephone 165
 - Directed Pickup
 - Feature description 104
 - Directory Numbers 173
 - DISA**
 - description 185
 - Disconnect protection 172
 - Disconnect Supervision 174
 - Displays
 - One-line 74
 - Prime telephone 83
 - Two-line 74
 - Do Not Disturb 78, 82, 88, 179
 - Feature description 128
- E**
-
- Emergency calls
 - Priority call 160
 - Emergency telephone 166
 - Enter code
 - Speed dial 169
 - Enter zone**
 - Page 159
 - Exclusive hold 136
 - Feature description 136
 - Extension numbers (See Directory Numbers)
 - External call
 - ringing 79
 - External line Access Code 123
 - External lines
 - Line/telephone filter 41
-

Extra-dial telephone 166
 additional Direct-Dial 54

F

Feature
 Programming 129
 Feature Buttons 154,155
 Features
 Cancelling 76
 Overview 74
 Restrictions 42
 Filters
 Line 47
 Line with COS 50
 Line/telephone 41
 Remote Access dialing 47
 User 50
 Forward denied
 Call forward 89
 Forwarding (See Call Forward)
 Call Forward No Answer 45
 Call Forward On Busy 44
 Full Handsfree
 programming 42

G

Get call first
 Call Park 102
 Group Listen
 Feature description 132
 Group Pickup
 Feature description 104

H

Handsfree
 Answerback 43
 Automatic 43
 Etiquette 134
 Full Handsfree 42
 Handsfree/Mute 78

Feature description 133
 Headset
 Answering a call 156
 Full Handsfree 42
 Operating 156
 Hold
 Listen on hold 135
 Music, Tones or Silence 136
 on M7100 telephone 136
 Hold Button 154
 Hold description 135
 Hold or release
 Feature programming 130
 Host System Signaling 137
 Link 137
 Pause 137
 Programmed Release 137
 Run/Stop 138
 Timed Release 138
 Hotline
 Programming 46
 Hotline telephone 166
 Hung lines
 releasing 174

I

Incoming only
 Line redirection 143
 Indicators 79
 Internal call
 ringing 79
 Internal numbers (See
 Directory Numbers)
Invalid zone
 Page 159

L

Language choice 118
 Last Number Redial
 Feature description 123

-
- Line Abilities
 - Line Filter 47
 - Remote Filter 47
 - Remote Package 47
 - Line Buttons 155
 - moving 119
 - Line denied
 - Call Pickup 105
 - Line filter
 - defaults 47
 - Line filters (COS)
 - defaults 50
 - Programming 50
 - Line in **use**
 - Hotline 167
 - Line Pools 175
 - Feature description 140
 - Hotline 46
 - preventing access 49
 - Ring Again 141
 - System Speed Dial 26
 - Line Profile 62
 - Line Redirection 89
 - Allow Redirect 45
 - Call forward No Answer 45
 - Feature description 142
 - Redirect Ring 46
 - System Speed Dial 26
 - Line Supervision 173
 - Line/telephone filters
 - number of 41
 - Lines
 - Line Pools 175
 - Prime 175
 - Private 175
 - Ringing preference 175
 - Target 176
 - Hung lines 174
 - Link 137
 - Feature description 137
 - Listen on Hold 135
 - Logit 94
 - Long Tones
 - Feature description 147
- ## M
-
- M7100**Telephone
 - Conferencing 113
 - display buttons 74
 - Hold 84, 136
 - selecting lines 76
 - User Card 203
 - M7208** Telephone
 - display buttons 74
 - User Card 206
 - M7310** Telephone
 - display buttons 21, 74
 - overlay 20
 - User Card 209
 - M7324** Telephone
 - display buttons 21, 74
 - overlay 20
 - User Card 212
 - Make call first
 - Camp on 109
 - group Listen 132
 - Make calls first
 - Conference 112
 - Memory buttons 154
 - Programming 129
 - Message** denied
 - Message 151
 - Message Waiting 11
 - Messages
 - Answering 148
 - displays 150
 - Erasing 148
 - Feature description 148
 - Sending 148
 - Music on Hold 136
-

N

Name
 System Speed Dial 27

Names
 entering letters 23
 Length 28
 Programming 28
 Valid characters 28

Need **Handsfree**
 Headset 157

Night Service
 Service modes 162

No **button free**
 Call Pickup 105
 Dialing 126
 Message 152

No calls waiting
 Answering the telephone 81

No last number
 Last number redial 126

No **1 line selected**
 Answering the telephone 81
 Dialing 126
 Hotline 167

No **1 line to use**
 Line redirection 143

No number saved
 Saved Number redial 126

No saved number
 Saved Number redial 126

No voice call
 Voice Call 188

Not in **service**
 Call forward 89
 Camp on 109

Numbers
 entering 22
 viewing 22

O

On-hook dialing 117

Outgoing line
 Line redirection 143

P

Page timeout
 Page 159

Paging
 Feature description 158
 preventing access 49
 zones 43,158

Paging **busy**
 Page 159

Park denied
 Call Park 103

Park ing full
 Call Park 103

Password
 Administration 55

Pause
 Feature description 137

Personal Speed Dial 168

Pick UP receiver
Call Queuing 81

Pickup
 Call Pickup programming 43

Pickup denied
 Call Pickup 105

Pool code
 Line redirection 143

Pre-Dial 117

Prime Line 175
 Hotline 46

Prime telephone 78, 167

Priority Call
 Feature description 160
 ring 79

Priority denied
 Priority call 160
Privacy
 Creating a conference 110
Private lines 175
 Call pickup 43, 105
Program and HOLD 131
Programmed Release
 Feature description 137
Programming
 Allow Redirect 45
 Automatic Handsfree 43
 Auxiliary Ringer 44
 Call Forward No Answer 45
 Call Forward On Busy 44
 Call Pickup (group) 43
 Capabilities 35
 COS Line filter 50
 Features 129
 Full Handsfree 42
 Handsfree Answerback 43
 Hotline 46
 Names 28
 Page Zone 43
 preparing for 14
 purpose 13
 Redirect Ring 46
 reminders 67
 Remote Packages 47
 Service mode
 Service Modes 51
 name 52
 Telephone filter 34, 40, 41
 tools 15
 Trunk Answer 54
 using display buttons 21
Programming Record 15
Pulse dialing 120

Q

Queuing
 priorities 107

R

Redir by 221
 Line redirection 144
Redirect Ring 79
 Programming 46
Release a **call**
 Answering the telephone 82
Release button 155
Relocating
 telephones 172
Remote Access
 Over a private Network 182
 Over a public Network 182
 Security 185
 Tones 184
 Using **Norstar** 183
Remote Access dialing filter 47
Remote Access Packages
 COS passwords 39
 defaults 39
 number of 39
 Programming 35, 39, 47
Restricted call
 Dialing 127
 Line redirection 144
Restrictions
 for External Users 35, 36
 for Internal Users 35, 36
 number of 37
Ring Again
 Feature description 123
Ring type 121

Ringing

- Changing the ring 120

- On/Off for lines 175

- Service Modes 54

- Volume 121

Run/Stop

- Feature description 138

S

Saved Number Redial

- Feature description 124

Service Modes 51

- Auxiliary Ringer 54

- cancelling 162

- Control telephone 51, 162

- Default start and stop times
53

- Extra-dial telephone 54, 166

- Feature description 162

- ON and OFF 52

- Programming 51

- Ringing 54

- Trunk Answer 54

Set Profile 62

Signaling

- Host System 137

Speaker

- Paging 158

- Telephone 43

Speed Dial

- Class of Service 170

- displays 169

- Feature description 168

- Personal programming **168**

Standard Dial 117

Supervision 174

System Speed Dial

- bypassing restrictions 27

- changing name 27

T

Target lines 176

- Call Forward On Busy 44

Telephone

- Administration lock 121

- Alarm 164

- buttons 154

- Control 165

- Customizing 116

- Direct-Dial 34, 44, 165

- Emergency 166

- Extra-Dial 166

- Hotline 166

- Names 28

- Prime 78, 167

- relocating 172

Telephone Abilities

- Allow Redirect 45

- Automatic Handsfree 43

- Auxiliary Ringer 44

- Call Forward No Answer 45

- Call Forward On Busy 44

- Call Pickup (group) 43

- Direct-Dial Telephones 44

- Full Handsfree 42

- Handsfree Answerback 43

- Hotline 46

- Line/telephone filter 41

- Page Zone 43**

- Priority Call 47

- Redirect Ring 46

Telephone User Cards 15

Their list full

- Message 152

Time

- display 177

- Feature description 177

Timed Release

- Feature description 138

Tones
 at Remote Access 184
 dialing 120
 Long 147

Tones denied
 Long Tones 147

Transfer
 displays 179
 external 178
 Feature description 178
 using Call Queuing 178
 using conference 178
 using Hold 179
 with announcement 178

Transfer denied
 Transfer 181

Trunk Answer
 Feature description 104
 programming 54

U

Unequipped line
 Line redirection 144

Upgrading
 Class of Service passwords
 49

V

Voice Call 158
 deny 187
 Feature description 187
 Handsfree Answerback 43,
 187
 muting tones 187

Voice Call Deny 78

Voice Message Center
 lines 60
 telephone numbers 60

Volume
 Button 155

Y

Your 1st full
 Message 152

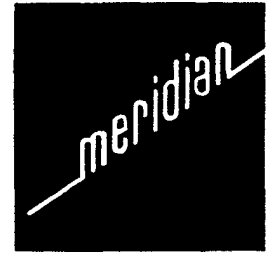

Norstar
Modular
Programming
Record

Note: This Programming **Record** is to be used with the **Norstar** Technical Training Course.

Customer/Company: _____ Sales Representative: _____
 Address: _____ Telephone: _____
 _____ Issue Date: _____

 Telephone: _____
 Billing Number: _____ Installer: _____
 System Coordinator: _____ Installation Date: _____
 Notes: _____

Hardware Record of Installed Equipment

Enter the quantity into the **box** (leave **empty** if none).

Modular Key Service Unit		Telephones	
Key Service Unit (KSU)		M7208	
Expansion Cartridge, 2-Port		M7310	
Expansion Cartridge, 6-Port		M7324	
Trunk Cartridge		M7310 with Busy Lamp Field (BLF)	
Trunk Module		M7324 with Central Answering Position (CAP) Module(s)	
Station Module		Analog Terminal Adapter (ATA) for single line phone	
Data Terminals		Auxiliary Equipment	
Analog Terminal Adapter (ATA)		Auxiliary Ringer	
		External Paging Equipment	
		Music Source	
		Emergency Telephone(s)	
		Station Auxiliary Power Supply	
		Headset	
		Shoulder Rest	
		Radio Frequency (RF) Filter Kit	

System Startup (Installer Only)

. Reset Memory? **If you reset the memory, all programming will be erased and reset to system defaults at end of System Stamp.**

Template

Press **CHANGE** to select one of the following:

- Square Line 1 and Line 2 are assigned to each telephone.
- Centrex Each telephone is assigned to a different line until no more lines remain.
- Hybrid Line 1 is assigned to each telephone and all telephones have access to Line Pool 1.
- PBX No line is assigned to any telephone, and all telephones have access to Line Pool 1:

. All defaults given in the Programming Record - shown in **Bold text** - correspond to settings for the default Square Template.

Instructions for Line Programming Record

	Line # _____	Enter the number of the line to be programmed. A line number must be two digits in length. A one digit line number requires a leading zero (examples: Line # 03 , or Line # 14).
--	--------------	---

1. Line Data (Installer Only)

Type		
Public	<input type="checkbox"/>	Choose one of the following: Check box if line can be assigned to any set.
Private to	_____	Enter the DN of the set to which the line will be Private.
Pool (1 to 9)	_____	Enter the number of the Line Pool to which this line will belong.

Mode		
Pulse	<input type="checkbox"/>	Choose the method of dialing for this line.
Tone	<input type="checkbox"/>	

Aux. Ringer		
Yes	<input type="checkbox"/>	Does the Auxiliary Ringer ring on incoming calls for this line?
No	<input type="checkbox"/>	

Full AutoHold (on idle line)		
No	<input type="checkbox"/>	Will the outgoing line, on which no digits have yet been dialed, be automatically placed on hold when another line is selected?
Yes	<input type="checkbox"/>	

Prime set		
(DN default is 21/221/2221)	_____	Enter the DN of the Prime Phone (backup answering) for this line, or None.

2. Names (General admin)

(maximum of 7 characters)	_____	Assign a Name (optional) to the line (maximum of 7 characters). Use the dialpad to enter the characters (example- WAIS1__).
---------------------------	-------	--

4. Restrictions (General admin)

Restriction Index number (maximum of 30 numbers)	_____ _____	Enter the Restriction Index number(s) (if any) to be applied. Options are 1 to 30 (example: 3,5-6,15). Refer to page 10 for the Restriction Index numbers which have been assigned Restrictions.
---	----------------	--

5. Overrides (General admin)

Override Index number (maximum of 10 numbers)	_____ _____	Enter the Override Index number(s) (if any) to be applied. Options are 1 to 10 (example: 1,2,3,8). Refer to page 10 for the Override Index numbers which have been assigned Overrides.
--	----------------	---

7. Night Service (General admin)

Night ctrl (Night Control Set)		
(DN default is 21/221/2221)	_____	Enter the DN of the Night Control Set for this line, or None.

Night ring (Night Ringing Set)		
(DN default is 21/221/2221)	_____	Enter the DN of the Night Ringing Set for this line, or None.

Night aux ring (Night Auxiliary Ringer)		
Yes	<input type="checkbox"/>	Will this line activate an Auxiliary Ringer when Night Service is ON?
No	<input type="checkbox"/>	

Use the Copy Record to record the line settings to be copied with the **COPY** display button.

Line Programming Record

	L i n e #	Line #	Line #	Line #
1. Line Data (Installer Only)				
Type				
Public	<input type="checkbox"/>	<input type="checkbox"/>	<input type="checkbox"/>	<input type="checkbox"/>
Private to	_____	_____	_____	_____
Pool (1 to 9)	_____	_____	_____	_____
Mode				
Pulse	<input type="checkbox"/>	<input type="checkbox"/>	<input type="checkbox"/>	<input type="checkbox"/>
Tone	<input type="checkbox"/>	<input type="checkbox"/>	<input type="checkbox"/>	<input type="checkbox"/>
Aux. Ringer				
Yes	<input type="checkbox"/>	<input type="checkbox"/>	<input type="checkbox"/>	<input type="checkbox"/>
No	<input type="checkbox"/>	<input type="checkbox"/>	<input type="checkbox"/>	<input type="checkbox"/>
Full AutoHold (on idle line)				
No	<input type="checkbox"/>	<input type="checkbox"/>	<input type="checkbox"/>	<input type="checkbox"/>
Yes	<input type="checkbox"/>	<input type="checkbox"/>	<input type="checkbox"/>	<input type="checkbox"/>
Prime set				
(DN default is 21/221/2221)	_____	_____	_____	_____
2. Names (General admin)				
(maximum of 7 characters)	-----	-----	-----	-----
4. Restrictions (General ad				
Restriction Index number (maximum of 30 numbers)	_____	_____	_____	_____
5. Overrides (General admir				
Override Index number (maximum of 10 numbers)	_____	_____	_____	_____
7. Night Service (General admin)				
Night ctrl (Night Control Set)				
(DN default is 21/221/2221)	_____	_____	_____	_____
Night ring (Night Ringing Set)				
(DN default is 21/221/2221)	_____	_____	_____	_____
Night aux ring (Night Auxiliary Ringer)				
Yes	<input type="checkbox"/>	<input type="checkbox"/>	<input type="checkbox"/>	<input type="checkbox"/>
No	<input type="checkbox"/>	<input type="checkbox"/>	<input type="checkbox"/>	<input type="checkbox"/>

	Set # _____	Enter the DN of the set to be programmed. DNs are 2, 3, or 4 digits in length, depending on the DN length in effect (example: Set # 223).
	Model _____	Enter the set model (example: M731Q).

2. Line Access (Installer Only)

Line assignment and Ringing

Ring		<i>Default is assignment of Lines 1 and 2 -both No ring (Ring on set 21/221/2221).</i> Enter the Line Numbers which are assigned to this set and will Ring (example: 1,2,10-11).
No ring		Enter the Line Numbers which are assigned to this set and will not Ring (example: 3,4,5-8,12-20).

Answer DNs and Ringing

Ring		<i>A maximum of four Answer DNs may be assigned to one set. Default is None.</i> Enter the Answer Group DNs (if any) which will also Ring at this set.
No ring		Enter the Answer Group DNs (if any) which will not Ring at this set.

Line pool access

(default is No Line Pool)	_____	Enter the Line Pool numbers that are accessible by this set (example: 1,2,5). Options are NO (none), or 1 to 9 .
---------------------------	-------	--

Intercom keys

(default is 2 intercom keys)	_____	Enter the number of Intercom keys for this set. Options are 0 to 8.
-------------------------------------	-------	---

Prime line

None	<input type="checkbox"/>	Choose one of the following: Check the box if there is no Prime Line. If the Prime Line is an outside line, enter the Line number. If the Prime Line is a Line Pool, enter the Line Pool number. Check the box if the Prime Line is an intercom (WC).
Line #	_____	
Pool #	_____	
WC	<input type="checkbox"/>	

2. Names (General admin)

(maximum of 7 characters)	_____	Assign a Name (optional) to the set (maximum of 7 characters). Use the dialpad to enter the characters (example: G E O R G E) .
---------------------------	-------	--

4. Restrictions (General admin)

Restriction Index number (maximum of 30 numbers)	_____	Enter the Restriction Index number(s) (if any) to be applied. Options are 1 to 30 (example: 1,2,16-25). Refer to page 10 for the Restriction Index numbers which have been assigned Restrictions.
---	-------	---

5. Overrides (General admin)

Override Index number (maximum of 10 numbers)	_____	Enter the Override Index number(s) (if any) to be applied. Options are 1 to 10 (example: 1,2,3,8). Refer to page 10 for the Override Index numbers which have been assigned Overrides.
--	-------	--

6. Permissions (General admin)

Full handsfree	Yes <input type="checkbox"/> No <input type="checkbox"/>	Choose if the set is to have Full Handsfree capability.
HF Answerback	Yes <input type="checkbox"/> No <input type="checkbox"/>	Choose if the set is to have Handsfree (HF) Answerback capability.
Pickup group (default is NO)	_____	Enter one Pickup Group number. Options are No (none), or 1 to 9.
Page zone (default is 1)	_____	Enter one Page Zone number. Options are No (none), or 1 to 8.
Aux. Ringer	Yes <input type="checkbox"/> No <input type="checkbox"/>	Choose if the telephone will activate an installed Auxiliary Ringer.
Forward no answer	_____	Enter the DN (if any) of the set which will receive unanswered calls.
	_____	Enter the number of rings before the unanswered call is Forwarded (if a Forward to DN is assigned), Options are 2,3,4,6 , and 10.
Priority call	Yes <input type="checkbox"/> No <input type="checkbox"/>	Choose if the set is allowed to use the Priority Call feature.

• Use the Copy Record to record the line settings to be copied with the **COPY** display button.

Set Programming Record

	Set # _____	Set # _____	Set # _____	Set # _____
	Model _____	Model _____	Model _____	Model _____

2. Line Access (Installer Only)

Line assignment and Ringing

Ring	_____	_____	_____	_____
No ring	_____	_____	_____	_____

Answer DN's and Ringing

Ring	_____	_____	_____	_____
No ring	_____	_____	_____	_____

Line pool access

(default is No Line Pool)	_____	_____	_____	_____
---------------------------	-------	-------	-------	-------

Intercom keys

(default is 2 intercom keys)	_____	_____	_____	_____
------------------------------	-------	-------	-------	-------

Prime line

None	q	<input type="checkbox"/>	<input type="checkbox"/>	<input type="checkbox"/>
Line #	_____	_____	_____	_____
Pool #	_____	_____	_____	_____
I/C	<input type="checkbox"/>	<input type="checkbox"/>	<input type="checkbox"/>	<input type="checkbox"/>

2. Names (General admin)

(maximum of 7 characters)	_____	_____	_____	_____
---------------------------	-------	-------	-------	-------

4. Restrictions (General admin)

Restriction index number (maximum of 30 numbers)	_____	_____	_____	_____
---	-------	-------	-------	-------

5. Overrides (General admin)

Override Index number (maximum of 10 numbers)	_____	_____	_____	_____
--	-------	-------	-------	-------

6. Permissions (General admin)

Full handsfree	Yes <input type="checkbox"/> No <input type="checkbox"/>	Yes <input type="checkbox"/> No <input type="checkbox"/>	Yes <input type="checkbox"/> No <input type="checkbox"/>	Yes <input type="checkbox"/> No <input type="checkbox"/>
HF Answerback	Yes <input type="checkbox"/> No <input type="checkbox"/>	Yes <input type="checkbox"/> No <input type="checkbox"/>	Yes <input type="checkbox"/> No <input type="checkbox"/>	Yes <input type="checkbox"/> No <input type="checkbox"/>
Pickup group (default is NO)	_____	_____	_____	_____
Page zone (default is 1)	_____	_____	_____	_____
Aux. Ringer	Yes <input type="checkbox"/> No <input type="checkbox"/>	Yes <input type="checkbox"/> No <input type="checkbox"/>	Yes <input type="checkbox"/> No <input type="checkbox"/>	Yes <input type="checkbox"/> No <input type="checkbox"/>
Forward no answer <div style="border: 1px solid black; padding: 2px; display: inline-block;"> Forward to (default DN is None) Forward delay (default rings is 3) </div>	_____	_____	_____	_____
Priority call	Yes <input type="checkbox"/> No <input type="checkbox"/>	Yes <input type="checkbox"/> No <input type="checkbox"/>	Yes <input type="checkbox"/> No <input type="checkbox"/>	Yes <input type="checkbox"/> No <input type="checkbox"/>

3. Call handling

Held reminder	Choose if the Held Line Reminder feature is to be active.
Remind delay (secs.)	Choose the number of seconds delay before Held Line Reminder begins at a set.
DRT to prime	Choose if the Delayed Ring Transfer (to Prime Set) feature is to be active.
DRT delay (rings)	Choose the number of rings delay before a Delayed Ring Transfer to Prime set.
Transf r callbk (rings)	Choose the number of rings at a set before Transfer Callback occurs.
Park timeout (secs.)	Choose the number of seconds before a Callback occurs on a Parked call.
Directed pickup	Choose if the Directed Pickup feature is to be active.
On hold	Choose what will be heard by a caller on an outside line when placed on hold.

4. Miscellaneous

Backgrnd music	Choose if the Background Music feature is to be active.
Dial-O set (21/221/2221)	Assign the DN of the set which receives Dial-O calls, or None.
Alarm set (21/221/2221)	Assign the DN of the set that receives Alarm messages, or None.
Link time (ms.)	Choose the Link time in milliseconds.
Set relocation	Choose if the Set Relocation feature is to be active.
Line pool codes (1 to 4 digits in length)	Assign the Line Pool codes for each desired Line Pool (Line Pool codes have no defaults)
Installer pswd.	<i>(Record the Installer Password in the Meridian Norstar Modular Pocket Installation Guide)</i> Change, if required, the six character Installer Password.

5. Change DNs

Individual DNs	Individual DNs may be changed. All DNs must be of the same length.
DN length	Assign the system-wide DN length. Available DN lengths are 2, 3 or 4 digits for a non-Expanded system, and 3 or 4 digits for an Expanded system. <i>(Note: All calls are dropped if the DN length is changed. All Administration and Configuration programming is retained.)</i>

3. Call handling

Held reminder	Yes <input type="checkbox"/>	No <input type="checkbox"/>				
Remind delay (secs.)	30 <input type="checkbox"/>	60 <input type="checkbox"/>	90 <input type="checkbox"/>	120 <input type="checkbox"/>	150 <input type="checkbox"/>	180 <input type="checkbox"/>
DRT to prime	Yes <input type="checkbox"/>	No <input type="checkbox"/>				
DRT delay (rings)	1 <input type="checkbox"/>	2 <input type="checkbox"/>	3 <input type="checkbox"/>	4 <input type="checkbox"/>	6 <input type="checkbox"/>	
Transfr callbk (rings)	3 <input type="checkbox"/>	4 <input type="checkbox"/>	5 <input type="checkbox"/>	6 <input type="checkbox"/>	12 <input type="checkbox"/>	
Park timeout (secs.)	30 <input type="checkbox"/>	45 <input type="checkbox"/>	60 <input type="checkbox"/>	90 <input type="checkbox"/>	120 <input type="checkbox"/>	150 <input type="checkbox"/> 180 <input type="checkbox"/>
Directd pickup	Yes <input type="checkbox"/>	No <input type="checkbox"/>				
On hold	Music <input type="checkbox"/>	Tones <input type="checkbox"/>	Silence <input type="checkbox"/>			

4. Miscellaneous

Backgrnd music	Yes <input type="checkbox"/>	No <input type="checkbox"/>				
Dial-0 set (21/221/2221)	_____					
Alarm set (21/221/2221)	_____					
Link time (ms.)	300 <input type="checkbox"/>	400 <input checked="" type="checkbox"/>	500 <input type="checkbox"/>	600 <input type="checkbox"/>	700 <input type="checkbox"/>	800 <input type="checkbox"/> 900 <input type="checkbox"/> 1000 <input type="checkbox"/>
Set relocation	Yes <input type="checkbox"/>	No <input type="checkbox"/>				
Line pool codes (1 to 4 digits in length)	Line pool 1: _____	Line pool 2: _____	Line pool 3: _____	Line pool 4: _____	Line pool 5: _____	Line pool 6: _____
				Line pool 7: _____	Line pool 8: _____	Line pool 9: _____

Installer pswd. *(Record the Installer Password in the Meridian Norstar Modular Pocket Installation Guide)*

5. Change DNs

Individual DNs	<i>Change DNs as required.</i>
DN length	_____
	<i>(Note: All calls are dropped if the DN length is changed. All Administration and Configuration programming is retained.)</i>

Administration Access Code

To begin General Administration:

Press [Feature] [*] [*] [A] [D] [M] [I] [N] or [Feature] [*] [*] [2] [3] [6] [4] [6]

Administration Password

Record the Administration Password here (if assigned):

1. Sys speed dial

Maximum length of each Speed Dial code is 16 digits.

- | | | |
|-----------|-----------|-----------|
| #01 _____ | #25 _____ | #49 _____ |
| #02 _____ | #26 _____ | #50 _____ |
| #03 _____ | #27 _____ | #51 _____ |
| #04 _____ | #28 _____ | #52 _____ |
| #05 _____ | #29 _____ | #53 _____ |
| #06 _____ | #30 _____ | #54 _____ |
| #07 _____ | #31 _____ | #55 _____ |
| #08 _____ | #32 _____ | #56 _____ |
| #09 _____ | #33 _____ | #57 _____ |
| #10 _____ | #34 _____ | #58 _____ |
| #11 _____ | #35 _____ | #59 _____ |
| #12 _____ | #36 _____ | #60 _____ |
| #13 _____ | #37 _____ | #61 _____ |
| #14 _____ | #38 _____ | #62 _____ |
| #15 _____ | #39 _____ | #63 _____ |
| #16 _____ | #40 _____ | #64 _____ |
| #17 _____ | #41 _____ | #65 _____ |
| #18 _____ | #42 _____ | #66 _____ |
| #19 _____ | #43 _____ | #67 _____ |
| #20 _____ | #44 _____ | #68 _____ |
| #21 _____ | #45 _____ | #69 _____ |
| #22 _____ | #46 _____ | #70 _____ |
| #23 _____ | #47 _____ | |
| #24 _____ | #48 _____ | |

2. Names

Record the Names to be assigned in the Set and Line Programming Records.

3. Time and date

Assign the Time and Date as required.

4. Restrictions

Table entries

Enter a Restriction for each Restriction Index number. Maximum length of each Restriction is 8 characters.
 (The default Restrictions are shown and may be changed if desired)

#1	0	#11		#21	
#2	1	#12		#22	
#3	411	#13		#23	
#4	1*1*	#14		#24	
#5	1*0*	#15		#25	
#6		#16		#26	
#7		#17		#27	
#8		#18		#28	
#9		#19		#29	
#10		#20		#30	

Applied to lines and Applied to sets

- assign Restrictions to lines on the Line Programming Record
- assign Restrictions to sets on the Set Programming Record

5. Overrides

Table entries

Enter an Override for each Override Index **number**. Maximum length of each Override is 14 characters.
 (The default Overrides are shown and may be changed if desired)

#1	1800	#6	
#2	1555	#7	
#3	1*1*555	#8	
#4	1*0*555	#9	
#5	911	#10	

Applied to lines and Applied to sets

- assign Overrides to lines on the Line Programming Record
- assign Overrides to sets on the Set Programming Record

6. Permissions

Record the Permissions to be assigned in the Set Programming Record. The Permissions include:

- Full Handsfree activation
- HF (Handsfree) Answerback activation
- Pickup Group assignment
- Page Zone assignment
- Auxiliary Ringer activation
- Forward No Answer (DN) assignment
- Forward Delay assignment
- Priority Call activation

7. Night Service

Trunk answer **Yes** **No**

Night-O set (default DN is **21/221/2221**) _____

Night ctrl (Night Control Set) (see Line Programming Record)

Night ring (Night Ringing Set) (see Line Programming Record)

Night aux. ring (Night Auxiliary Ringer) (see Line Programming Record)

8. Passwords

Admin. password

Change, if desired, the one to six digit Administration Password. Record the new Password on the top of page 9.

Restriction pswd (Restriction Override Passwords)

(Restriction Override Passwords must be 4 digits in length)

00 _____	25 _____	50 _____	75 _____
01 _____	26 _____	51 _____	76 _____
02 _____	27 _____	51 _____	77 _____
03 _____	26 _____	53 _____	78 _____
04 _____	29 _____	54 _____	79 _____
05 _____	30 _____	55 _____	80 _____
06 _____	31 _____	56 _____	81 _____
07 _____	32 _____	57 _____	82 _____
06 _____	33 _____	58 _____	83 _____
09 _____	34 _____	59 _____	84 _____
10 _____	35 _____	60 _____	85 _____
11 _____	3 _____ 6 _____	61 _____	86 _____
12 _____	37 _____	62 _____	87 _____
13 _____	38 _____	63 _____	88 _____
14 _____	39 _____	64 _____	89 _____
15 _____	4 _____ 0 _____	65 _____	90 _____
16 _____	41 _____	66 _____	91 _____
17 _____	42 _____	67 _____	92 _____
16 _____	43 _____	68 _____	93 _____
19 _____	44 _____	69 _____	94 _____
20 _____	45 _____	70 _____	95 _____
21 _____	46 _____	71 _____	96 _____
22 _____	47 _____	72 _____	97 _____
23 _____	48 _____	73 _____	98 _____
24 _____	49 _____	74 _____	99 _____

The following is a review of each of the main headings which are in the Programming Record and appear on the display during programming. A checked box, , beside a heading indicates that line, set, or system-wide settings can be programmed if programming for that heading is selected.

Programming Headings		Type of Programming		
Main Heading	Sub-heading	Line	Set	System-wide
System Startup <small>(heading does not appear on display)</small>	Template	<input type="checkbox"/>	<input type="checkbox"/>	<input checked="" type="checkbox"/>
A. Configuration	1. Line Data	<input checked="" type="checkbox"/>	<input type="checkbox"/>	<input type="checkbox"/>
	2. Line Access	<input type="checkbox"/>	<input checked="" type="checkbox"/>	<input type="checkbox"/>
	3. Call Handling	<input type="checkbox"/>	<input type="checkbox"/>	<input checked="" type="checkbox"/>
	4. Miscellaneous	<input type="checkbox"/>	<input type="checkbox"/>	<input checked="" type="checkbox"/>
	5. Change DNs	<input type="checkbox"/>	<input checked="" type="checkbox"/>	<input checked="" type="checkbox"/>
B. General admin	1. Sys speed dial	<input type="checkbox"/>	<input type="checkbox"/>	<input checked="" type="checkbox"/>
	2. Names	<input checked="" type="checkbox"/>	<input checked="" type="checkbox"/>	<input type="checkbox"/>
	3. Time and date	<input type="checkbox"/>	<input type="checkbox"/>	<input checked="" type="checkbox"/>
	4. Restrictions	<input checked="" type="checkbox"/>	<input checked="" type="checkbox"/>	<input type="checkbox"/>
	5. Overrides	<input checked="" type="checkbox"/>	<input checked="" type="checkbox"/>	<input type="checkbox"/>
	6. Permissions	<input checked="" type="checkbox"/>	<input checked="" type="checkbox"/>	<input type="checkbox"/>
	7. Night Service	<input checked="" type="checkbox"/>	<input type="checkbox"/>	<input checked="" type="checkbox"/>
	6. Passwords	<input type="checkbox"/>	<input type="checkbox"/>	<input checked="" type="checkbox"/>
C. Set Copy		<input type="checkbox"/>	<input checked="" type="checkbox"/>	<input type="checkbox"/>